

MODEL

UNT6217Z

embraco

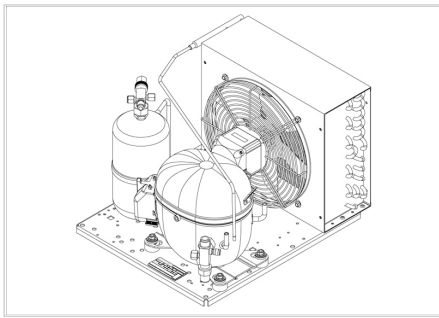



APPROVALS



 **ENGINEERING CODE**
602DA5212AA

 **APPROVED REFRIGERANT**
R134a

 **POWER SUPPLY**
220 - 240V 50Hz ~

 **STANDARD CONDITIONS**
EN13215_SH10

 **APPLICATION**
M/HBP

 **COOLING CAPACITY**
918 W

 **EFFICIENCY**
1.48 W/W

DATA

General Data

Weight	30.1 Kg
Receiver	2.3 L
Height	324 mm
Length	494 mm
Width	395 mm
Power Supply	220 - 240 V 50 Hz

Electrical Data

Motor Type	CSIR
Locked Rotor Amperage (LRA)	25 A
Max Current	5.43 A

Spare Parts

Valve Discharge	FLARE 3/8"	2110056
Valve Suction	FLARE 1/2"	2110057
Condenser	3R12T	2451218
Compressor	NT6217Z	212BA09..AC
Electrical Kit	ELKOM NT6217Z	212BA0412A
Fan Kit	34W 275/31°/5B	1996588

Noise Data

Sound Power Level	67.5 dB (A)	-	-
Sound Pressure Level	at 1 m	at 5 m	at 10 m
	59.5 dB (A)	45.5 dB (A)	39.5 dB (A)

Fan Motor

Number	1
Shaft Power	34 W
Air Flow	640 m ³ /h
Blade diameter	275 mm

PERFORMANCE

Rated Points

Ambient Temperature	Cooling Capacity	Power Consumption	Current	Efficiency
32.00°C	918 W	620 W	4.55 A	1.48 W/W

Test Condition: EN13215_SH10, Return Gas 0 °C, Subcooling 3K , Evaporation -10.00°C, Condensing 0 °C, Ambient 32.00°C

Performance Curve Data

Ambient Temperature 25°C

Evaporating Temperature °C	Cooling Capacity W	Power Consumption W	Current A	Efficiency W/W
-15	819	543	4.25	1.51
-10	1016	602	4.42	1.69
-5	1255	664	4.61	1.89
0	1538	732	4.82	2.1
5	1870	808	5.08	2.31
10	2253	897	5.4	2.51

Test Condition: EN13215_SH10, M/HBP

Ambient Temperature 32°C

Evaporating Temperature °C	Cooling Capacity W	Power Consumption W	Current A	Efficiency W/W
-15	739	558	4.38	1.33
-10	918	620	4.55	1.48
-5	1134	685	4.75	1.66
0	1393	756	4.97	1.84
5	1696	834	5.24	2.03
10	2049	923	5.57	2.22

Test Condition: EN13215_SH10, M/HBP

Ambient Temperature 43°C

Evaporating Temperature °C	Cooling Capacity W	Power Consumption W	Current A	Efficiency W/W
-15	591	584	4.42	1.01
-10	762	656	4.63	1.16
-5	966	730	4.86	1.32
0	1206	807	5.12	1.49
5	1487	892	5.43	1.67
10	1813	985	5.79	1.84

Test Condition: EN13215_SH10, M/HBP

Operating Envelope

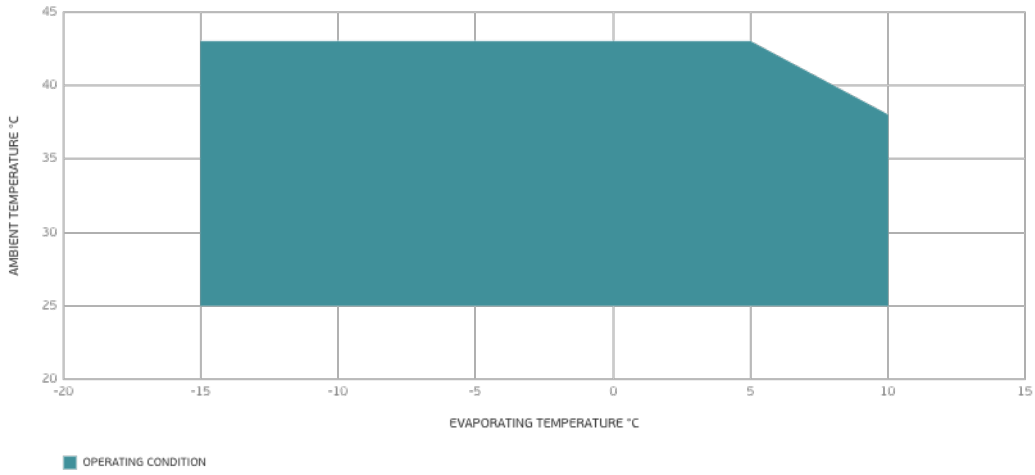

External Dimensions

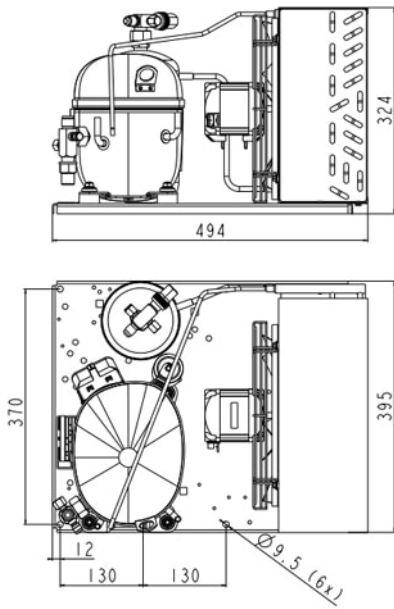

Wiring Diagram

