

MODEL

UNJ6220Z

embraco

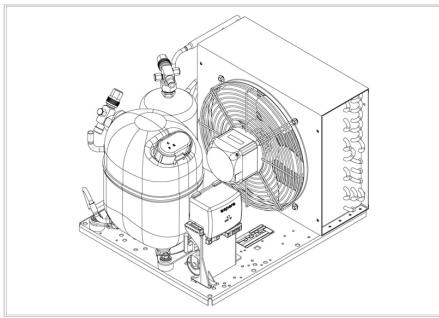



APPROVALS



 **ENGINEERING CODE**
644HA5604AA

 **APPROVED REFRIGERANT**
R134a

 **POWER SUPPLY**
220 - 240V 50Hz ~

 **STANDARD CONDITIONS**
EN13215_SH10

 **APPLICATION**
M/HBP

 **COOLING CAPACITY**
1202 W

 **EFFICIENCY**
1.57 W/W

DATA

General Data

Weight	37.4 Kg
Receiver	2.3 L
Height	324 mm
Length	481 mm
Width	410 mm
Power Supply	220 - 240 V 50 Hz

Electrical Data

Motor Type	CSR
Locked Rotor Amperage (LRA)	35 A
Max Current	6.45 A

Spare Parts

Condenser	3R12T	2451140
Valve Suction	SOLDER 1/2"	2110050
Valve Discharge	SOLDER 3/8"	2110049
Compressor	NJ6220Z	144HA19..AC
Electrical Kit	ELKOM NJ6220Z	144HA1904V
Fan Kit	34W 275/31°/5B	1996583

Noise Data

Sound Power Level	72.1 dB (A)	-	-
Sound Pressure Level	at 1 m	at 5 m	at 10 m
	64.1 dB (A)	50.1 dB (A)	44.1 dB (A)

Fan Motor

Number	1
Shaft Power	34 W
Air Flow	640 m³/h
Blade diameter	275 mm

PERFORMANCE

Rated Points

Ambient Temperature	Cooling Capacity	Power Consumption	Current	Efficiency
32.00°C	1202 W	767 W	5.85 A	1.57 W/W

Test Condition: EN13215_SH10, Return Gas 0 °C, Subcooling 3K , Evaporation -10.00°C, Condensing 0 °C, Ambient 32.00°C

Performance Curve Data

Ambient Temperature 25°C

Evaporating Temperature °C	Cooling Capacity W	Power Consumption W	Current A	Efficiency W/W
-15	1059	674	5.61	1.57
-10	1339	744	5.79	1.8
-5	1658	824	6.02	2.01
0	2018	913	6.3	2.21
5	2419	1011	6.63	2.39
10	2864	1116	6.98	2.57

Test Condition: EN13215_SH10, M/HBP

Ambient Temperature 32°C

Evaporating Temperature °C	Cooling Capacity W	Power Consumption W	Current A	Efficiency W/W
-15	945	688	5.64	1.37
-10	1202	767	5.85	1.57
-5	1495	855	6.12	1.75
0	1823	952	6.43	1.92
5	2189	1056	6.78	2.07
10	2595	1168	7.16	2.22

Test Condition: EN13215_SH10, M/HBP

Ambient Temperature 43°C

Evaporating Temperature °C	Cooling Capacity W	Power Consumption W	Current A	Efficiency W/W
-15	749	704	5.68	1.06
-10	984	795	5.92	1.24
-5	1246	893	6.21	1.4
0	1538	999	6.55	1.54
5	1862	1111	6.93	1.68
10	2219	1229	7.33	1.81

Test Condition: EN13215_SH10, M/HBP

Operating Envelope

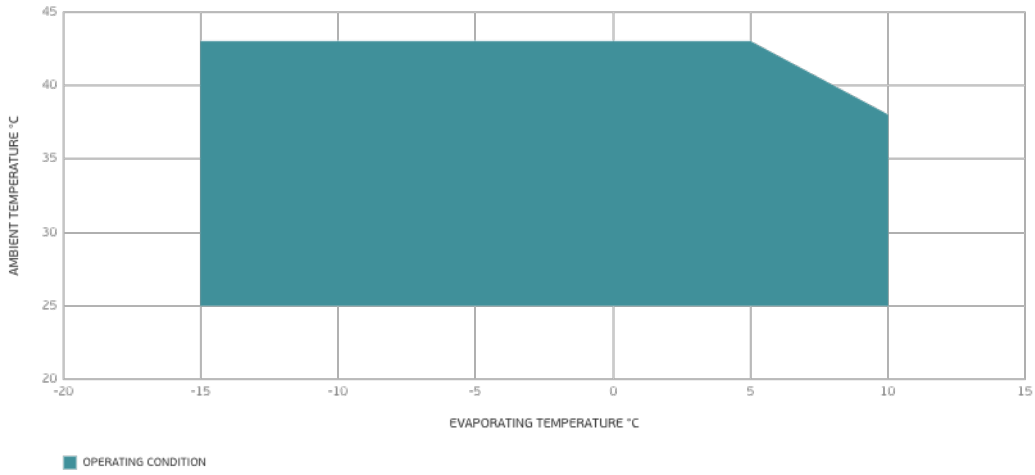

External Dimensions

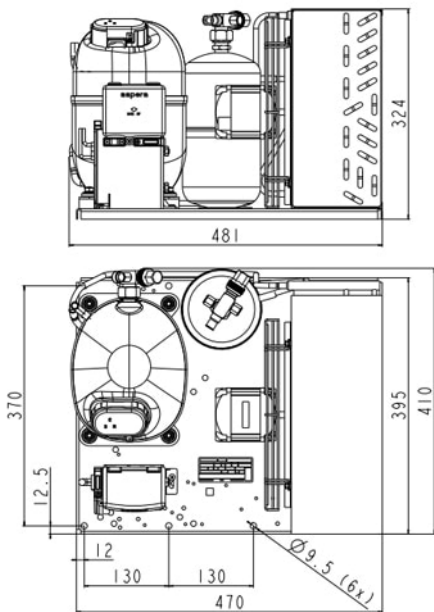

Wiring Diagram

