

HITACHI

Centrifugal VRF

Cooling & Heating





—
CONTENTS

CENTRIFUGAL VRF

HITACHI

**The ideal solution
for small businesses**

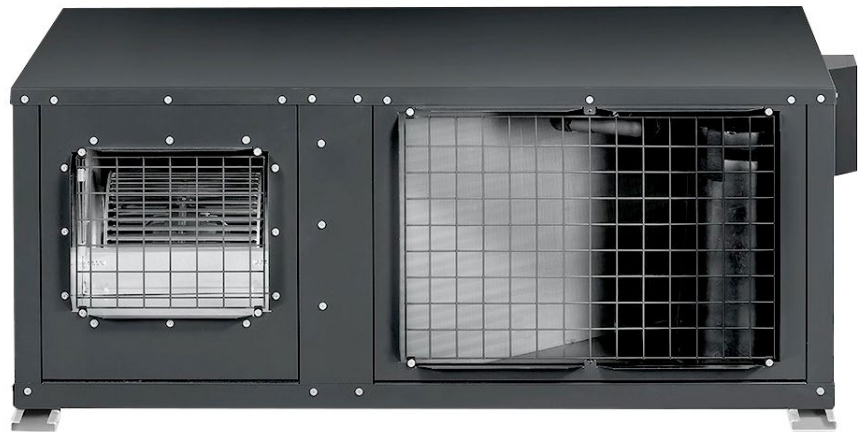

04 RASC Centrifugal VRF

08 Indoor Unit Combinations

10 System Sizing - Mono, Twin, Triple, Quad

12 Distribution In Line

RASC CENTRIFUGAL VRF

RASC CENTRIFUGAL VRF

Choosing the most suitable air conditioning for your project has a major impact on its future. An outdoor unit with a radial fan for indoor installation offers comfort to your clients while hiding inside the building to meet even the most demanding pampering demands.

- **Larger external static fan pressure:**
to circulate air through duct path.
- **Higher comfort and energy savings:**
thanks to independent control for up to 6 zones
- **Easier installation and maintenance:**
simple and convenient ,with components installed outdoors.
- **Reduced consumption because it adapts to the requirements of each environment:**
it can be combined with 16 different types of indoor units
- **Greater flexibility:**
Connectable indoor unit power 75% to 120%, it is possible to combine different types of indoor units from 0.8 HP
- **Higher efficiency:**
it is equipped with two HITACHI inverters, the first controls the compressor, the second fan
- **Silent operation:**
noise reduction around the building

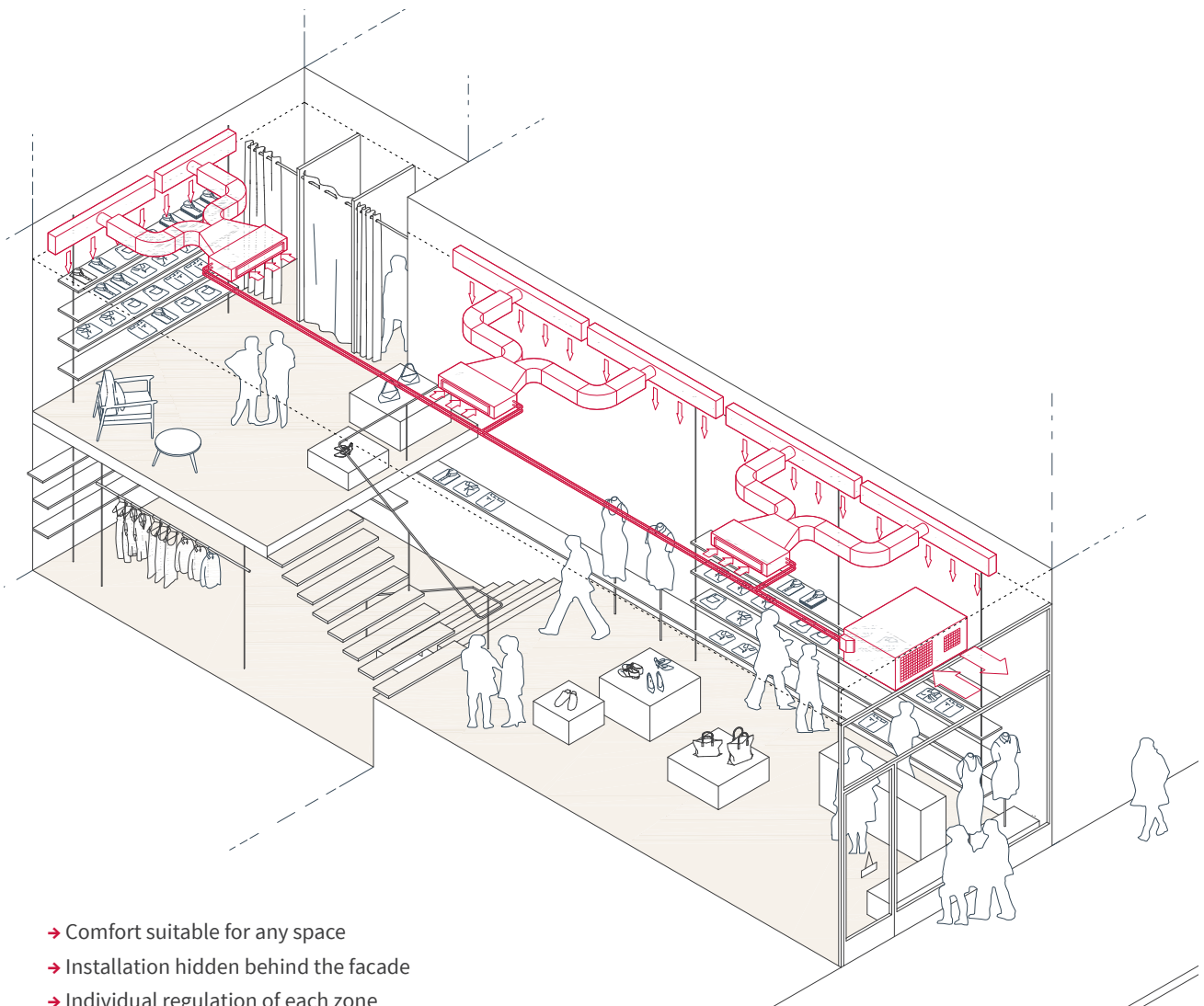

Hot Gas Bypass Technology

The time of continuous heating increases 40% versus the previous version

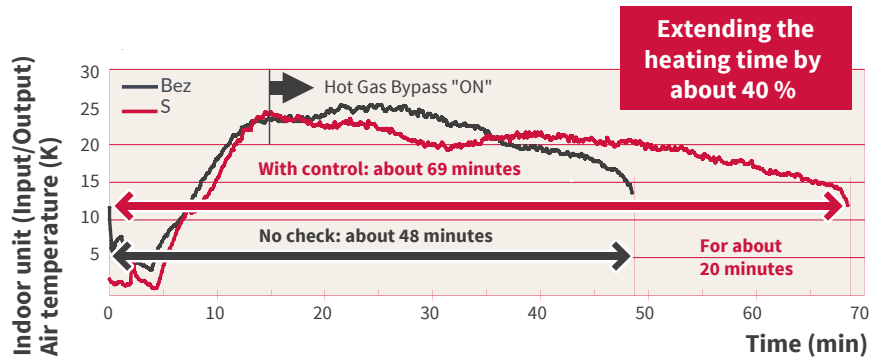

Outdoor unit with a centrifugal fan

It uses **HITACHI** high pressure vertical compressor, which guarantees the adjustable capacity coefficients characteristic of VRF systems.

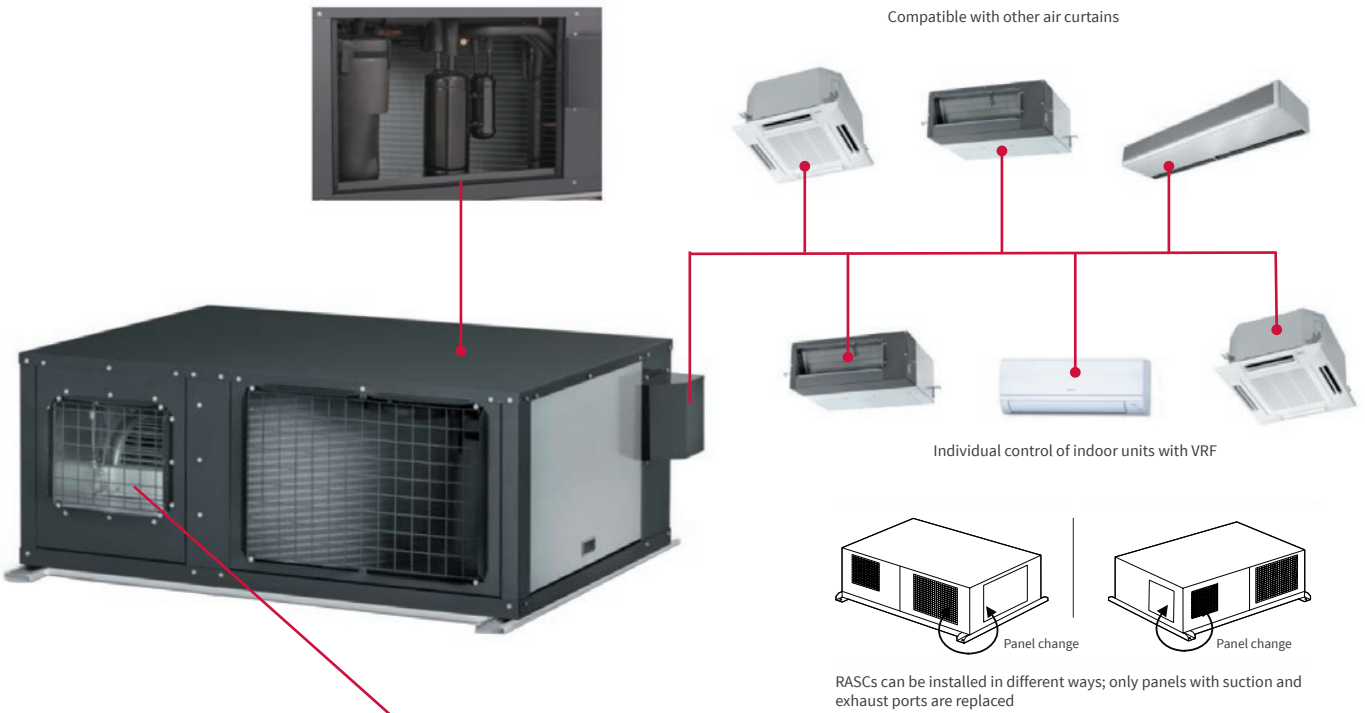

Centrifugal fan

Variable Frequency Drive Control

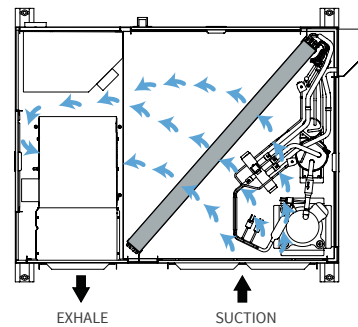

RASC CENTRIFUGAL VRF

RASC CENTRIFUGAL VRF

RASC-4HNPE
RASC-5HNPE
RASC-6HNPE



RASC-8HNPE
RASC-10HNPE



RASC Centrifugal were the first units with a radial fan on the VRF market

- High-pressure **HITACHI** vertical scroll compressor with 75% -120% range, offering cooling capacity from 7.5 kW to 30 kW
- Hot Gas Bypass Technology
- “Smart Defrost“ control
- Centrifugal fan controlled by variable frequency drive (Variable Frequency Drive)
- Individual regulation of indoor units by VRF technology
- Up to 6 different indoor units (the smallest type 0.8 HP)
- Three-phase power supply
- Adjustable inputs / outputs
- Complies with the requirements of the ErP Class 11 Directive
- Compatible with other air curtains

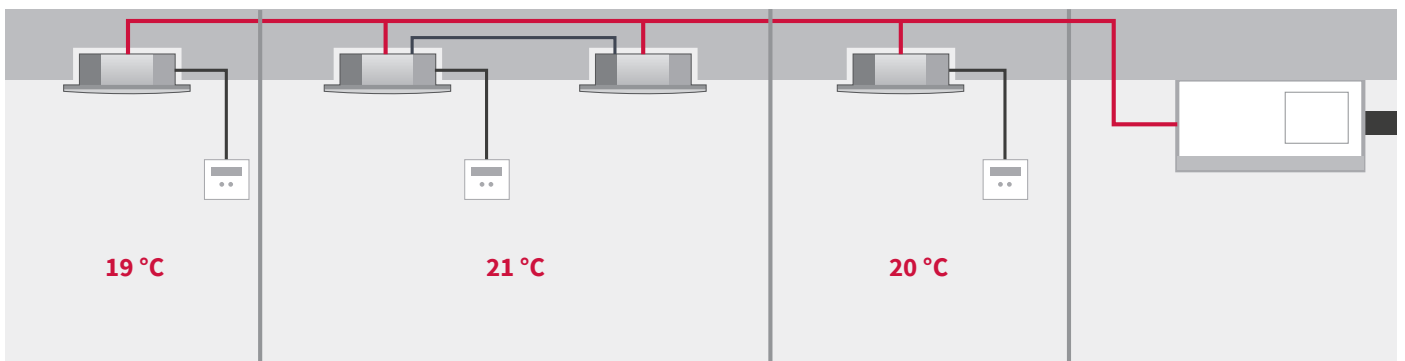

Example of connection

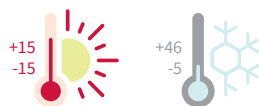

Specifications

		RASC-4HNPE	RASC-5HNPE	RASC-6HNPE	RASC-8HNPE	RASC-10HNPE
Power supply	Ph/V/Hz	3N/400 V/50 Hz	3N/400 V/50 Hz	3N/400 V/50 Hz	3N/400 V/50 Hz	3N/400 V/50 Hz
Nominal cooling power (1)	kW	10.0	12.5	14.0	20.0	24.0
Nominal heating power (2)	kW	11.2	14.0	15.5	22.4	26.0
Operating current (Cooling / Heating)	A	4.8/4.7	6.4/6.6	8.2/9.2	11.9/11.2	14.5/13.7
Nominal power input (Cooling / Heating)	kW	2.99/2.95	3.98/4.12	5.09/5.74	7.41/7.00	9.02/8.52
EER/COP (4)		3.35/3.80	3.14/3.40	2.75/2.70	2.70/3.20	2.66/3.05
Energy Class		A/A	B/C	D/E	D/D	D/D
ESEER	W/W	6.65	6.41	6.19	6.15	6.13
Connectable min-max power	%	75-120	75-120	75-120	75-120	75-120
Number of indoor units max	N.	5	5	5	6	6
Sound pressure level Cooling / Heating (night operation) (3)	dB(A)	52-53 (48)	52-53 (48)	53-54 (49)	55-56 (51)	56-57 (52)
Sound power level at nominal power	dB(A)	71	71	72	74	75
Sound power level at nominal power (max)	m ³ /h	3300	3600	3600	6900	6900
Static pressure (nom/max)	Pa	56/90	72/100	100/100	84/120	102/120
Dimensions (HxWxD)	mm	555×1415×1015	555×1415×1015	555×1415×1015	620×1850×1360	620×1850×1360
Weight	kg	192	192	192	300	300
Operating temperature range for cooling	°C	-5/+46 (DB)	-5/+46 (DB)	-5/+46 (DB)	-5/+46 (DB)	-5/+46 (DB)
Range of operating temperatures during heating	°C	-15/+15 (WB)	-15/+15 (WB)	-15/+15 (WB)	-15/+15 (WB)	-15/+15 (WB)
Refrigerant precharge (R-410A)	kg (GWP eq Ton)	4.1 (8.56)	4.2 (8.76)	4.2 (8.76)	5.7 (11.90)	6.2 (12.94)
Minimum pipe length	m	5	5	5	5	5
Maximum piping length without additional refrigerant charge	m	30	30	30	30	30
Maximum pipe length (additional refrigerant charge)	m (g/m)	75 (60)	75 (60)	75 (60)	100 (according to the calculation)	100 (according to the calculation)
Maximum height difference (outdoor unit up / down)	m/m	30/20	30/20	30/20	30/20	30/20
Liquid piping diameter	mm (inch)	9.53 (3/8)	9.53 (3/8)	9.53 (3/8)	9.53 (3/8)	12.7 (1/2)
Diameter of the gas pipe	mm (inch)	15.88 (5/8)	15.88 (5/8)	15.88 (5/8)	25.4 (1)	25.4 (1)

The above mentioned cooling and heating performance refers to outdoor units that are connected to indoor units at 100% capacity and are based on EN 14511.

(1) Cooling: indoor temperature 27 °C (19 °C WB) - outdoor temperature 35 °C; cooling pipe length 7.5 m; height difference 0 m.

(2) Heating: indoor temperature 20 °C - outdoor temperature 7 °C (6 °C WB); cooling pipe length 7.5 m; height difference 0 m.

(3) The sound pressure level is measured according to EN12102 in the exhaust pipe.

(4) The COP and EER values apply to the connection to RCI cassette indoor units

RASC CENTRIFUGAL VRF INDOOR UNIT COMBINATIONS

Model	Indoor unit minimum capacity	Maximum number of connecting indoor units	1 Unit		2 Units	
			Combination	Multikit		
RASC 4HNPE	0.8 HP	5	75-120 % from 3 to 4.8 HP	75-120 % from 3 to 4.8 HP	E-102SN4	
RASC 5HNPE	0.8 HP	5	75-120 % from 3.75 to 6 HP	75-120 % from 3.75 to 6 HP	E-102SN4	
RASC 6HNPE	0.8 HP	5	75-120 % from 4.5 to 7.2 HP	75-120 % from 4.5 to 7.2 HP	E-102SN4	
RASC 8HNPE	0.8 HP	6	75-120 % from 6 to 9.6 HP	75-120 % from 6 to 9.6 HP	E-162SN4	
RASC 10HNPE	0.8 HP	6	75-120 % from 7.5 to 12 HP	75-120 % from 7.5 to 12 HP	E-162SN4	
Model	Indoor unit minimum capacity	Maximum number of connecting indoor units	4 Units			
			Combination	Multikit	Piping connection	
RASC 4HNPE	0.8 HP	5	75-120 % from 3 to 4.8 HP	3 x E-102SN4	MH-84AN1	
RASC 5HNPE	0.8 HP	5	75-120 % from 3.75 to 6 HP	3 x E-102SN4	MH-84AN1	
RASC 6HNPE	0.8 HP	5	75-120 % from 4.5 to 7.2 HP	3 x E-102SN4	MH-84AN1	
RASC 8HNPE	0.8 HP	6	75-120 % from 6 to 9.6 HP	(*) The first pipe connection: E-162SN4 The next two MULTIKIT: E-102SN4	MH-84AN1	
RASC 10HNPE	0.8 HP	6	75-120 % from 7.5 to 12 HP	(*) The first pipe connection: E-162SN4 The next two MULTIKIT: E-102SN4	MH-84AN1	

(*) If the power ratio between the two OD branches of the first pipe connection is greater than 60/40%, use distribution in line.

(**) If more than 4 indoor units are connected, it is recommended to control the data listed in Table 1 to optimize the balance between indoor units.

TABLE 1

When installing multiple indoor units for connecting indoor units with minimal power and other indoor units to the same cooling circuit, refer to the data in this table

The largest indoor unit connected	HP	0.8	1.0	1.3	1.5	1.8	2.0	2.3	2.5	3.0	4.0	5.0	6.0
The smallest indoor unit	HP	0.8			1.0			1.3		1.5	1.8	2.0	

TABLE 2

When installing all RCI-FSN3 indoor units, the maximum power output is 100% and the maximum number of removable indoor units 4.

3 Units

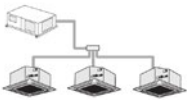
TRIPLE		Distribution in line	
			
Combination	Multikit	Combination	Multikit
75-120 % from 3 to 4.8 HP	MH-84AN1	75-120 % from 3 to 4.8 HP	2 x E-102SN4
75-120 % from 3.75 to 6 HP	MH-84AN1	75-120 % from 3.75 to 6 HP	2 x E-102SN4
75-120 % from 4.5 to 7.2 HP	MH-84AN1	75-120 % from 4.5 to 7.2 HP	2 x E-102SN4
75-120 % from 6 to 9.6 HP	MH-84AN1	75-120 % from 6 to 9.6 HP	1 x E-162SN4 + 1 x E-102SN4
75-120 % from 7.5 to 12 HP	MH-84AN1	75-120 % from 7.5 to 12 HP	1 x E-162SN4 + 1 x E-102SN4

4 Units

5 Units

6 Units



Distribution in line		Distribution in line (**)		Distribution in line (**)	
					
Combination	Multikit	Combination	Multikit	Combination	Multikit
75-120 % from 3 to 4.8 HP	3 x E-102SN4	75-100 % from 3 to 4 HP	4 x E 102SN4	-----	
75-120 % from 3.75 to 6 HP	3 x E-102SN4	75-100 % from 3.75 to 5 HP	4 x E 102SN4	-----	
75-120 % from 4.5 to 7.2 HP	3 x E-102SN4	75-100 % from 4.5 to 6 HP	4 x E 102SN4	-----	
75-120 % from 6 to 9.6 HP	2 x E-162SN4 + 1 x E-102SN4	75-100 % from 6 to 8 HP	3 x E-162SN4 + 1 x E-102SN4	75-100 % from 6 to 8 HP	4 x E-162SN4 + 1 x E-102SN4
75-120 % from 7.5 to 12 HP	2 x E-162SN4 + 1 x E-102SN4	75-100 % from 7.5 to 10 HP	3 x E-162SN4 + 1 x E-102SN4	75-100 % from 7.5 to 10 HP	4 x E-162SN4 + 1 x E-102SN4

TABLE 3

An external exchanger can be connected via a DX kit with up to 30% of the RASC condensing unit.

TABLE 4

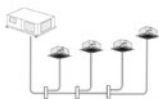
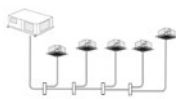
For 8 and 10 HP systems, COMBINATION MONO is allowed; however, the following special combinations are also allowed for the RASC-10HNPE series:

SPECIAL PERMITTED COMBINATION

System with 2 indoor units	System with 3 indoor units
8.0 + 3.0	8.0 + 2.0 + 2.0
8.0 + 2.0	8.0 + 1.5 + 1.5
10.0 + 3.0	8.0 + 1.0 + 1.0
10.0 + 2.0	10.0 + 1.5 + 1.5
	10.0 + 1.0 + 1.0

Comments

If the parameters are close to the maximum (long pipe length, high altitude difference, etc.), it is recommended to follow the data in Table 1 (see notes) for maximum comfort.

RASC CENTRIFUGAL VRF SYSTEM SIZING - MONO, TWIN, TRIPLE, QUAD

Maximum lengths of the cooling pipe

Units		4 HP	5 HP	6 HP	8 HP	10 HP	
Maximum pipe length between the RASC and the furthest inner unit	Actual pipe length (L)		75		100		
	Equivalent pipe length (EL)		95		125		
Total maximum pipe length	2 indoor units (A + B + C)		85		100	115	
	3 indoor units (A + B + C + D)		95		100	130	
	4 indoor units	Case a) (A + B + C + D + E + F + G)		95		100	145
		Case b) (A + B + C + D + E)		-		100	145
Maximum pipe length between the pipe connection and the indoor unit	2 indoor units (A + B + C)		10		15		
	3 indoor units (A + B + C + D)		10		15		
	4 indoor units	Case a) (A + B + C + D + E + F + G)		10		15	
		Case b) (A + B + C + D + E)		-		15	
The maximum height difference between the RASC and the indoor unit (H)	RASC unit higher than indoor unit			30			
	Indoor unit higher than RASC			20			
Maximum height difference between indoor units				10			
Maximum height difference between pipe joints / pipe joints and indoor units				3			
The difference in the lengths of the pipe sections must not be greater than the one shown below					(4/10) HP (m)		
2 indoor units			(B-C)		8		
3 indoor units			(B-C, B-D, C-D)				
4 indoor units		Case a)	(B+(D o E)) - (C+(F o G))				
			(D-E)				
		(F-G)					
Case b) only for (8/10) HP			(B-C, B-D, B-E, C-D, C-E, D-E)				

System with 1 indoor unit

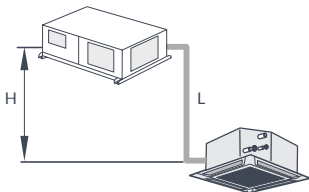

RASC capacity	Tube diameter (L) (mm)	
	Gas	Liquid
(4-6) HP	Ø 15.88	Ø 9.52
8 HP (*)	Ø 25.4	Ø 9.52
10 HP (**)	Ø 25.4	Ø 12.7

(*) The RPI-8.0 HP Indoor Unit comes with 1 reduction:
- Reduction of the gas pipe: from Ø 19.05 to Ø 25.4

(**) The RPI-10.0 HP Indoor Unit comes with 2 reductions:
- Reduction of gas pipes: Ø 22,2n and Ø 25.4
- Liquid line reduction: from Ø 9.52 to Ø 12.7

System with 2 indoor units

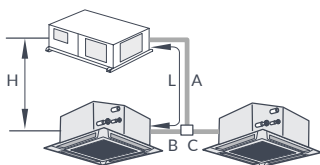

RASC capacity	Tube diameter (A) (mm)		Piping connection
	Gas	Liquid	
4 HP	Ø 15.88	Ø 9.52	E-102SN4
(5/6) HP	Ø 15.88	Ø 9.52	E-102SN4
8 HP	Ø 25.4	Ø 9.52 (*)	E-162SN4
10 HP	Ø 25.4	Ø 12.7	E-162SN4

(*) If the pipe length exceeds 70 m for the 8 HP model, use a liquid pipe Ø 12.7 and the corresponding pipe joint.

Indoor unit capacity	Tube diameter (B, C) (mm)	
	Gas	Liquid
(0.8-1.5) HP	Ø 12.7	Ø 6.35
(1.8/2.0) HP	Ø 15.88	Ø 6.35
(2.3-6.0) HP	Ø 15.88	Ø 9.52
8.0 HP	Ø 19.05	Ø 9.52
10.0 HP	Ø 22.20	Ø 9.52

System with 3 indoor units

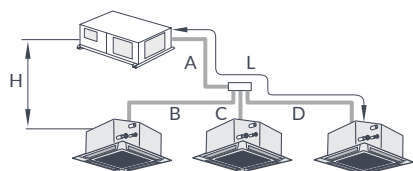

(*) If the pipe length (A + B or A + C or A + D) exceeds 70 m for the 8 HP model, use a liquid pipeline with Ø 12.7

RASC capacity	Tube diameter (A) (mm)		Piping connection
	Gas	Liquid	
(4-6) HP	Ø 15.88	Ø 9.52	MH-84AN1
8 HP	Ø 25.4	Ø 9.52 (*)	MH-84AN1
10 HP	Ø 25.4	Ø 12.7	MH-84AN1

Indoor unit capacity	Tube diameter (B, C) (mm)	
	Gas	Liquid
(0.8-1.5) HP	Ø 12.7	Ø 6.35
(1.8/2.0) HP	Ø 15.88	Ø 6.35
(2.3-6.0) HP	Ø 15.88	Ø 9.52
8.0 HP	Ø 19.05	Ø 9.52
10.0 HP	Ø 22.20	Ø 9.52

System with 4 indoor units

• Case a)

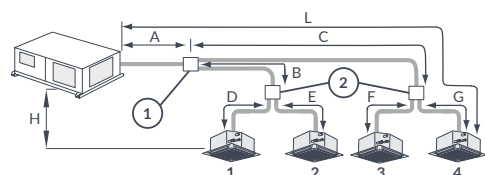

(*) If the pipe length (A+B+(C or D) or A+C+(F or G)) exceeds 70 m for the 8 HP model, use Ø 12.7 pipe.

RASC capacity	Tube diameter (A) (mm)		Piping connection
	Gas	Liquid	
4/5/6 HP	Ø 15.88	Ø 9.52	E-102SN4
8 HP	Ø 25.4	Ø 9.52 (*)	E-162SN4
10 HP	Ø 25.4	Ø 12.7	E-162SN4

Total capacity of the indoor unit on the first box (1+2) O (3+4)	Tube diameter (B, C) (mm)		Piping connection
	Gas	Liquid	
(0.8-1.5) HP	Ø 12.7	Ø 6.35	E-102SN4
(1.8/2.0) HP	Ø 15.88	Ø 6.35	E-102SN4
≥ 2.3 HP	Ø 15.88	Ø 9.52	E-102SN4

Indoor unit capacity	Tube diameter (D, E, F, G) (mm)	
	Gas	Liquid
(0.8-1.5) HP	Ø 12.7	Ø 6.35
(1.8/2.0) HP	Ø 15.88	Ø 6.35
≥ 2.3 HP	Ø 9.52	Ø 6.35

It is not possible to connect using indoor units with the power of 8.0 HP and 10.0 HP

• Case b)

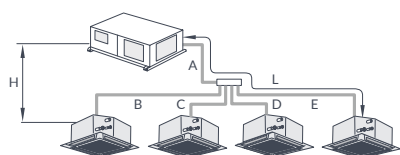

(*) If the pipe length (A+B or A+C or A+D or A+E) exceeds 70 m for the 8 HP model, use Ø 12.7 pipe. Only possible for outdoor units with power of 8 and 10.0 HP

RASC capacity	Tube diameter (A) (mm)		Piping connection
	Gas	Liquid	
8 HP	Ø 25.4	Ø 9.52 (*)	MH-84AN1
10 HP	Ø 25.4	Ø 12.7	MH-84AN1

Indoor unit capacity	Tube diameter (D, E, F, G) (mm)	
	Gas	Liquid
(0.8-1.5) HP	Ø 12.7	Ø 6.35
(1.8/2.0) HP	Ø 15.88	Ø 6.35
≥ 2.3 HP	Ø 15.88	Ø 9.52

It is not possible to connect using indoor units with the power of 8.0 HP and 10.0 HP

RASC CENTRIFUGAL VRF - DISTRIBUTION IN LINE

Maximum lengths of the cooling pipe

Units		4 HP	5 HP	6 HP	8 HP	10 HP
Maximum pipe length between the RASC and the furthest inner unit	Actual pipe length (L1)		75		100	
	Equivalent pipe length (EL)		95		125	
Total maximum pipe length (L1+ L31 + L32 +... + L3n-1)		95			100	145
Maximum pipe length from the first pipeline to the outermost unit (L2)		30			40	
Maximum pipe length between pipe connection and indoor unit (L31, L32, L33..., L3n)		10			15	
The maximum height difference between the RASC and the indoor unit (Hi-o)	RASC unit higher than indoor unit			30		
	Indoor unit higher than RASC			20		
Maximum height difference between indoor units (Hi)				10		
Maximum height difference between pipe joints / pipe joints and indoor units				3		

Installation of pipe branches

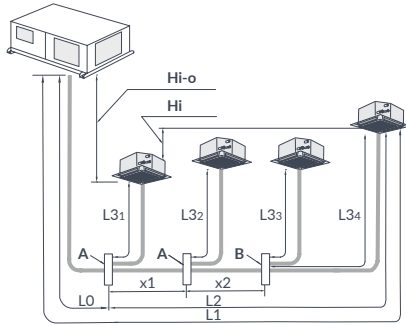

RASC capacity	Tube diameter (L0, X1, X2) (mm)		Piping connection A	Piping connection B
	Gas	Liquid		
(4-6) HP	Ø 15.88	Ø 9.52	E-102SN4	E-102SN4
8 HP	Ø 25.4	Ø 9.52 (*)	E-162SN4	E-102SN4
10 HP	Ø 25.4	Ø 12.7	E-162SN4	E-102SN4

(*) In the case of combinations with 10.0 HP internal units, only one of two E-102SN4E coupling connections allows a 22.2 mm diameter pipe that corresponds to a 10 HP indoor unit. Note this limitation when installing this size of the indoor unit.

Indoor unit capacity	Tube diameter (D, E, F, G) (mm)	
	Gas	Liquid
(0.8-1.5) HP	Ø 12.7	Ø 6.35
(1.8/2.0) HP	Ø 15.88	Ø 6.35
(2.3-6.0) HP	Ø 15.88	Ø 9.52

(*) In the case of combinations with 10.0 HP internal units, only one of two E-102SN4E coupling connections allows a 22.2 mm diameter pipe that corresponds to a 10 HP indoor unit. Note this limitation when installing this size of the indoor unit.

Combination of diameters and pipe lengths

Pipe length between RASC and the furthest inner unit (m)

Operating performance	Liquid	Ø 6.35		Ø 9.52				Ø 12.70				Ø 15.88				
	Gas	Ø 15.88	Ø 19.05	Ø 12.70	Ø 15.88	Ø 19.05	Ø 22.20	Ø 25.40	Ø 15.88	Ø 19.05	Ø 22.20	Ø 25.40	Ø 28.58	Ø 22.20	Ø 25.40	Ø 28.58
(4-6) HP		5 ²	5 ²	40 ¹	75	50 ⁴	-	-	30 ³	30 ³ 4 ⁴	-	-	-	-	-	-
8 HP		-	-	-	-	50 ¹ 4 ⁶	50 ¹ 6 ⁶	70 ⁵ 6 ⁶	-	50 ¹ 3 ⁴	50 ¹ 3 ³	100		50 ¹ 3 ³	50 ³	
10-12 HP		-	-	-	-	-	-	-	-	-	50 ¹	100	50	50 ¹ 3 ³	50 ³	50 ³

COMMENT

- (1) If the Gas Diameter is reduced, the cooling capacity is also reduced due to the increase in the pressure drop and the operating range is also reduced.
- (2) If the diameter of the liquid line is reduced, the operating range is also reduced due to the expansion valve performance. In these cases, set to ON pin # 1 for DSW2.
- (3) If the Liquid Pipe Diameter increases, additional refrigerant must be added.
- (4) If the Gauge Diameter Ø 19.05 (Soft Copper) is set, position ON pin 4 on the DSW2 in the PCB RASC.
- (5) If the pipe length is greater than 70 m for the 8 HP model, use a liquid pipe Ø 12.7.
- (6) If the recommended number of interconnected indoor units (more than 4 units) is exceeded, use a liquid pipe with Ø 12.7.

 Recommended

Equivalence table inches - mm

Inches mm	Inches mm	Inches mm	Inches mm	Inches mm	Inches mm	Inches mm	Inches mm
1/4" 6.35	3/8" 9.52	1/2" 12.7	5/8" 15.88	3/4" 19.05	7/8" 22.2	1" 25.4	1 1/8" 28.58

Installation centrifugal VRF in a bank branch at street level

- Installed in false ceiling, hidden in the facade.
- Indoor units of different typologies, depending on the use of each space.
- Independent control of each indoor unit for the comfort of different users.
- The unit consumes in accordance with the demands of each space.

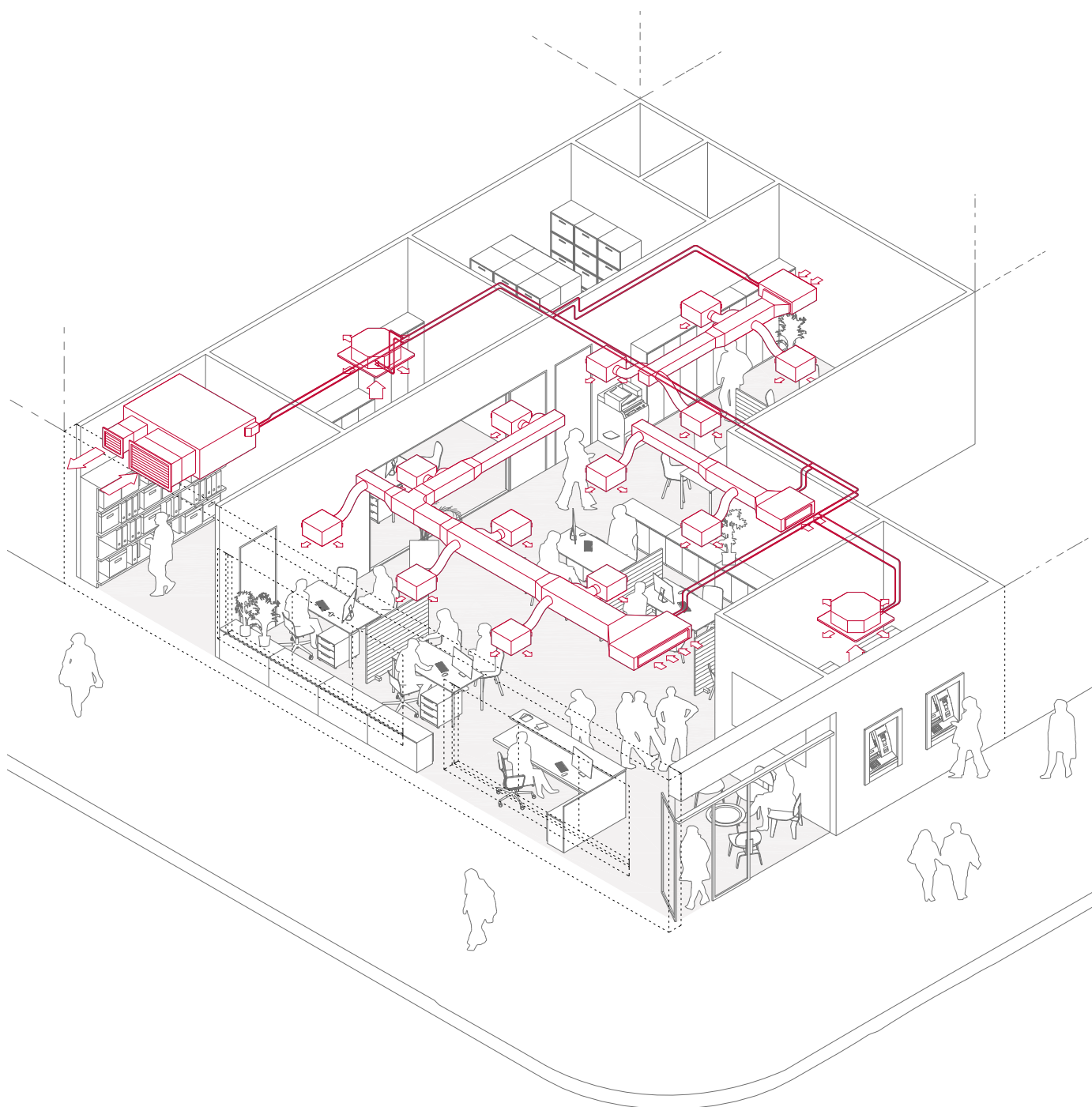



JOHNSON CONTROLS HQ HOLDING

CUSTOMER SERVICE

Johnson Controls

Email : BTS-P.D.-Communications@jci.com

SPARE PARTS

www.easyparts.johnsoncontrols.com

Tel : +44 (0) 1268 246 400

Email : be-parts-hitachi@jci.com

HITACHI. CERTIFIED QUALITY



HITACHI. TOTAL WARRANTY ON COMPRESSORS



www.hitachi-hvac.com/en

The specifications of this catalog may change without prior notice to allow HITACHI C&H to incorporate the latest innovations for its customers. The information contained in this catalog is merely informative. HITACHI C&H declines any responsibility in the broadest sense, for damage, direct or indirect, arising from the use and / or interpretation of the recommendations in this catalog

**Find the products Hitachi
C&H with the best service
and conditions at your
Hitachi Distributor.**