

Safety precautions



To prevent injury to the user or other people and property damage, the following instructions must be followed.

Incorrect operation due to ignoring instruction will cause harm or damage. The seriousness is classified by the following indications.

⚠ WARNING This symbol indicates the possibility of death or serious injury.

⚠ CAUTION This symbol indicates the possibility of injury or damage.

Meanings of symbols used in this manual are as shown below.

| | |
|---|---|
|  | Be sure not to do. |
|  | Be sure to follow the instruction. |

⚠ WARNING

Installation

- Do not use a defective or underrated circuit breaker. Use this appliance on a dedicated circuit.
 - There is risk of fire or electric shock.
- For electrical work, contact the dealer, seller, a qualified electrician, or an authorized service center.
 - Do not disassemble or repair the product. There is risk of fire or electric shock.
- Always ground the product.
 - There is risk of fire or electric shock.
- Install the panel and the cover of control box securely.
 - There is risk of fire or electric shock.
- Always install a dedicated circuit and breaker.
 - Improper wiring or installation may cause fire or electric shock
- Use the correctly rated breaker or fuse.
 - There is risk of fire or electric shock.
- Do not modify or extend the power cable.
 - There is risk of fire or electric shock.
- Do not install, remove, or re-install the unit by yourself (customer).
 - There is risk of fire, electric shock, explosion, or injury.

- Be cautious when unpacking and installing the product.
 - Sharp edges could cause injury. Be especially careful of the case edges and the fins on the condenser and evaporator.
- For installation, always contact the dealer or an authorized service center.
 - There is risk of fire, electric shock, explosion, or injury.
- Do not install the product on a defective installation stand.
 - It may cause injury, accident, or damage to the product.
- Do not let the ventilator run for a long time when the humidity is very high and a door or a window is left open.
 - Moisture may condense and wet or damage furniture.
- For re-installation of the installed product, always contact the dealer or an authorized service center.
 - There is risk of fire, electric shock, explosion or injury.
- Do not open the maintenance cover of the main body during operation.
 - Otherwise, it may cause electrical shock.
- Use the outdoor air suction hole with the net installed to ensure that birds could not come in.
 - Remove estrange things like the bird's nest. Otherwise, it may cause scarcity of indoor oxygen.
- Install the air intake where polluted air can not be directly sucked in.
 - It may cause various accidents, including suffocation, due to the suction of harmful gasses(CO, etc.)
- Install the product a place that can support its weight.
 - Otherwise, it may cause accident due to falling of the product.
- Precautions must be taken to avoid the back-flow of gases into the room from the open flue of gas or other fuel-burning appliances.
- When installing, servicing, or repairing the UV LED, the modules provided by LG Electronics must be used. If necessary, please contact an LG Electronics Service Center.
 - UV LED Module Information : LTPL-G35U275GS-TWA

Operation

- Take care to ensure that power cable could not be pulled out or damaged during operation.
 - There is risk of fire or electric shock.
- Do not place anything on the power cable.
 - There is risk of fire or electric shock.
- Do not touch(operate) the product with wet hands.
 - There is risk of fire or electrical shock.

- Do not place a heater or other appliances near the power cable.
 - There is risk of fire and electric shock.
- Do not allow water to run into electric parts.
 - It may cause There is risk of fire, failure of the product, or electric shock.
- Do not store or use flammable gas or combustibles near the product.
 - There is risk of fire or failure of product.
- When flammable gas leaks, turn off the gas and open a window for ventilation before turn the product on.
 - Do not use the telephone or turn switches on or off. There is risk of explosion or fire.
- If strange sounds, or smell or smoke comes from product. Turn the breaker off
 - There is risk of electric shock or fire.
- Stop operation and close the window in storm or hurricane. If possible, remove the product from the window before the hurricane arrives.
 - There is risk of property damage, failure of product, or electric shock.
- When the product is soaked (flooded or submerged), contact an authorized service center.
 - There is risk of fire or electric shock.
- Be cautious that water could not enter the product.
 - There is risk of fire, electric shock, or product damage.
- Turn the breaker off when cleaning or maintaining the product.
 - There is risk of electric shock.
- Don't touch a dedicated circuit or breaker with wet hands.
 - There is risk of electric shock.
- Use a firm stool or ladder when cleaning or maintaining the roduct.
 - Be careful and avoid personal injury.
- Be sure to turn off the main power for installation, service, and repair of the UV LED.
 - It may cause electric shock, injury, or death.
- This product is equipped with a UV-C lamp (UV LED). Do not stare at the UV LED.
 - Injury may occur.
- Do not operate the UV LED outside the product.
 - Injury may occur.
- Do not remove the parts inside the product with UV risk symbols. UV-C may be released from the UV LED.
 - Injury may occur.
- If the UV LED is damaged or needs to be replaced, please contact an LG Electronics Service Center.
 - Injury may occur.

- Be careful as UC-V may be released to the outside due to unintended use of the product or damage to the product. UV-C can harm the eyes and skin even if the exposure is small.
- Do not touch or clean the product while the UVnano function is operating.
- The UV-LED is a part that does not require cleaning. Do not separately clean parts with UV risk labels or the UV-LED.
 - Injury may occur.
- Unintended use of the appliance or damage to the housing may result in the escape of dangerous UV-C radiation. UV-C radiation may, even in little doses, cause harm to the eyes and skin.
- This appliance contains a UV-C lamp.
- When the appliances are damaged or need to be replaced, disconnect the power supply and contact the service center.
- Do not operate UV-C lamp outside of the appliance.
- Do not clean and touch air deflector during operation.
- Before opening doors and access panels bearing the ultraviolet radiation hazard symbol for the conducting user maintenance, it is recommended to disconnect the power.
- Read the maintenance instructions before opening the appliance.
- Appliances that are obviously damaged must not be operated.
- The appliance must be disconnected from the supply before replacing the UV-C lamp.
- This appliance contains a UV emitter. Do not stare at the light source.
- This appliance is not intended to be accessible to the general public.
- If the supply cord is damaged, it must be replaced by the manufacturer, its service agent or similarly qualified persons in order to avoid a hazard.

 **CAUTION**

Installation

- Use two or more people to lift and transport the product.
 - Avoid personal injury.
- Do not install the product where it will be exposed to sea wind (salt spray) directly.
 - It may cause corrosion on the product. Corrosion, particularly on the condenser and evaporator fins, could cause product malfunction or inefficient operation.
- If anyone other than a licensed Professional installs, repairs, or alters LG Electronics Air Conditioning Products, the warranty is voided.
 - All costs associated with repair are then the full responsibility of the owner.
- Do not install the unit in potentially explosive atmospheres.

- Doors and access panels bearing the ultraviolet radiation hazard symbol which may have UV-C spectral irradiance greater than $1.7 \mu\text{W}/\text{cm}^2$ are provided with an interlock switch to interrupt the power to the UV-C lamps for your safety. Do not over-ride.
- UV-C barriers bearing the ultraviolet radiation hazard symbol should not be removed.
- For appliances with UV-C lamps, information on the replacement of UV-C lamps shall be given, including the model and/or part number.
- If field installed, the factory specified UV-C germicidal lamp systems approved for use with the subject product shall be specified in the instructions by the specific model number.

Operation

- Do not expose the skin directly to cool air for long periods of time.
(Don't sit in the draft.)
 - This could harm to your health.
- Do not use the product for special purposes, such as preserving foods, works of art, etc. It is a consumer ventilator, not a precision refrigeration system.
 - There is risk of damage or loss of property.
- Use a soft cloth to clean. Do not use harsh detergents, solvents, etc.
 - There is risk of fire, electric shock, or damage to the plastic parts of the product.
- Do not step on or put anything on the product. (outdoor units)
 - There is risk of personal injury and failure of product.
- Use a firm stool or ladder when cleaning or maintaining the product.
 - Be careful and avoid personal injury.
- This appliance is not intended for use by persons (including children) with reduced physical, sensory or mental capabilities, or lack of experience and knowledge, unless they have been given supervision or instruction concerning use of the appliance by a person responsible for their safety. Children should be supervised to ensure that they do not play with the appliance.
- This appliance can be used by children aged from 8 years and above and persons with reduced physical, sensory or mental capabilities or lack of experience and knowledge if they have been given supervision or instruction concerning use of the appliance in a safe way and understand the hazards involved. Children shall not play with the appliance. Cleaning and user maintenance shall not be made by children without supervision.

Smart Functions

Using LG ThinQ Application

Things to check before using LG ThinQ

- For appliances with the  or **ThinQ** logo.
- 1. Check the distance between the appliance and the wireless router (Wi-Fi network).
 - If the distance between the appliance and the wireless router is too far, the signal strength becomes weak. It may take a long time to register or installation may fail.
- 2. Turn off the **Mobile data** or **Cellular Data** on your smartphone.

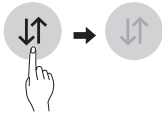

- 3. Connect your smartphone to the wireless router.

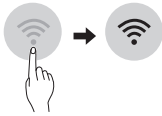

NOTE

- To verify the Wi-Fi connection, check that **Wi-Fi**  icon on the control panel is lit.
- The appliance supports 2.4 GHz Wi-Fi networks only. To check your network frequency, contact your Internet service provider or refer to your wireless router manual.
- LG ThinQ is not responsible for any network connection problems or any faults, malfunctions, or errors caused by network connection.
- If the appliance is having trouble connecting to the Wi-Fi network, it may be too far from the router. Purchase a Wi-Fi repeater (range extender) to improve the Wi-Fi signal strength.
- The Wi-Fi connection may not connect or may be interrupted because of the home network environment.
- The network connection may not work properly depending on the Internet service provider.
- The surrounding wireless environment can make the wireless network service run slowly.
- The appliance cannot be registered due to problems with the wireless signal transmission. Unplug the appliance and wait about a minute before trying again.
- If the firewall on your wireless router is enabled, disable the firewall or add an exception to it.
- The wireless network name (SSID) should be a combination of English letters and numbers. (Do not use special characters.)
- Smartphone user interface (UI) may vary depending on the mobile operating system (OS) and the manufacturer.
- If the security protocol of the router is set to **WEP**, you may fail to set up the network. Please change it to other security protocols (**WPA2** is recommended) and register the product again.

Installing LG ThinQ

Search for the LG ThinQ application from the Google Play Store or Apple App Store on a smart phone. Follow instructions to download and install the application.

Wi-Fi Function

- For appliances with the  or ThinQ logo

Communicate with the appliance from a smart phone using the convenient smart features.

Smart Diagnosis™

If you use the Smart Diagnosis function, you will be provided with the useful information such as a correct way of using the appliance based on the pattern of use.

Settings

Allows you to set various options on the appliance and in the application.

NOTE

- If you change your wireless router, Internet service provider, or password, delete the registered appliance from the LG ThinQ application and register it again.
- The application is subject to change for appliance improvement purposes without notice to users.
- Functions may vary by model.

Open Source Software Notice Information

To obtain the source code under GPL, LGPL, MPL, and other open source licenses that have the obligations to disclose source code, that is contained in this product, and to access all referred license terms, copyright notices and other relevant documents please visit <https://opensource.lge.com>.

LG Electronics will also provide open source code to you on CD-ROM for a charge covering the cost of performing such distribution (such as the cost of media, shipping, and handling) upon email request to opensource@lge.com.

This offer is valid to anyone in receipt of this information for a period of three years after our last shipment of this product.

Smart Diagnosis™ Using a Smart Phone

- For appliances with  the or  logo

Use this function if you need an accurate diagnosis by an LG Electronics customer information centre when the appliance malfunctions or fails.

Smart Diagnosis™ can not be activated unless the appliance is connected to power. If the appliance is unable to turn on, then troubleshooting must be done without using Smart Diagnosis™.

NOTE

- Be sure to keep ambient noise to a minimum or the phone may not correctly receive the buzzer beeps from the indoor unit.

Prior to operation

Preparing for operation

1. Contact an installation specialist for installation.
2. Plug in the power plug properly.
3. Use a dedicated circuit.
4. Do not use an extension cord.
5. Do not start/stop operation by plugging/unplugging the power cord.
6. If the cord/plug is damaged, replace it with only an authorized replacement part.

Usage

1. Being exposed to direct airflow for an extended period of time could be hazardous to your health. Do not expose occupants, pets, or plants to direct airflow for extended periods of time.
2. Due to the possibility of oxygen deficiency, ventilate the room when used together with stoves or other heating devices.
3. Do not use this ventilator for non-specified special purposes (e.g. preserving precision devices, food, pets, plants, and art objects). Such usage could damage the items.

Cleaning and maintenance

1. Do not touch the metal parts of the unit when removing the filter. Injuries can occur when handling sharp metal edges.
2. Do not use water to clean inside the ventilator. Exposure to water can destroy the insulation, leading to possible electric shock.
3. When cleaning the unit, first make sure that the power and breaker are turned off. The fan rotates at a very high speed during operation. There is a possibility of injury if the unit's power is accidentally triggered on while cleaning inner parts of the unit.
4. Ensure that the fan is switched off from the supply mains before removing the guard.

Service

For repair and maintenance, contact your authorized service dealer.

Introduction

Symbols used in this manual



This symbol alerts you to the risk of electric shock.



This symbol alerts you to hazards that could cause harm to the ventilator.

NOTICE

This symbol indicates special notes.

Features

WARNING

This appliance should be installed in accordance with national wiring regulations. This guide acts as a guide to help to explain product features.

WARNING

Indoor unit ground wires are required for preventing electrical shock accident during current leakage, communication disorder by noise effect and motor current leakage (without connection to pipe).

• 150 / 200 CMH

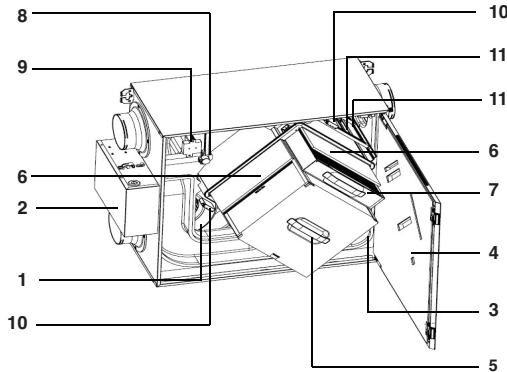

1. Ventilation blower

It is a blower for supplying outside air to the indoors.

2. Control box

It powers the control box product and controls the operation.

3. Exhaust blower

It is a blower for sending contaminated air to the outside.

4. Access door

It is an access door that opens and closes to check the heat exchange element and filters.

5. Total heat exchange element

It exchanges temperature and humidity between the ventilation and exhaust.

6. Pre-filter(Air filter)

It prevents clogging of the heat exchange element due to dust.

7. Fine filter

The pre-filter prevents the passage of fine dust that could not be blocked.

8. Bypass

It changes the flow path when changing the ventilation mode.

9. CO₂ sensor

When switched to automatic mode, checks the indoor CO₂ concentration to lower the CO₂ concentration by controlling the supply and discharge.

10. Dust sensor (indoor)

Checks the indoor/outdoor dust concentration to communicate the filter inspection status.

11. UV LED

UV LED irradiation takes place on the OA side (outdoor air intake side) pre-filter that touches the air to sterilize bacteria and viruses.

※ The figure of total heat exchanger can be different by the product model.

• 250 / 350 / 500 CMH

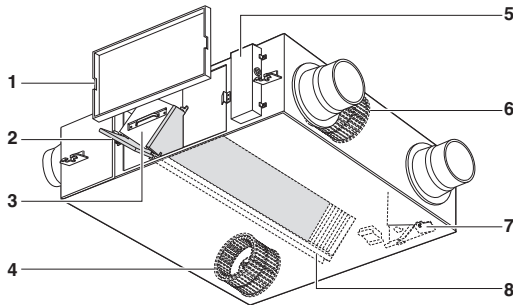

1. Maintenance cover

2. Air filter

It prevents dust from clogging in total heat exchanger.

3. Total heat exchanger

It changes temperature and humidity between supplying air and exhausted air.

4. Blower for exhaust air

It is a fan for discharging the contaminated air to outdoor.

5. Control box

6. Blower for supply air

It is a fan for inhaling exterior air into an indoor space.

7. Damper plate(Board)

It converts exchanging mode between total heat ventilation and general ventilation.

8. Total heat exchanger holder

It is used in guiding for the installation of total heat exchanger.

※ The figure of total heat exchanger can be different by the product model.

※ Optional filter(ISO ePM1 75 %) is available. It is sold separately.

• 800 / 1 000 CMH

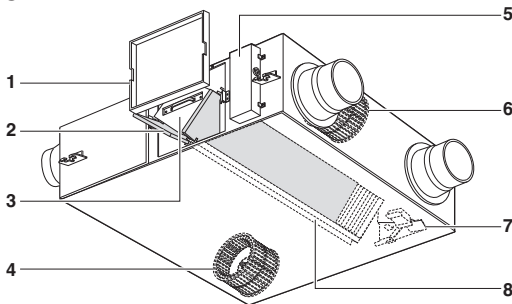

1. Maintenance cover

2. Air filter

It prevents dust from clogging in total heat exchanger.

3. Total heat exchanger

It changes temperature and humidity between supplying air and exhausted air.

4. Blower for exhaust air

It is a fan for discharging the contaminated air to outdoor.

5. Control box

6. Blower for supply air

It is a fan for inhaling exterior air into an indoor space.

7. Damper plate(Board)

It converts exchanging mode between total heat ventilation and general ventilation.

8. Total heat exchanger holder

It is used in guiding for the installation of total heat exchanger.

※ The form of total heat exchanger varies according to models.

※ Optional filter(ISO ePM1 75 %) is available. It is sold separately.

• 1 500 / 2 000 CMH

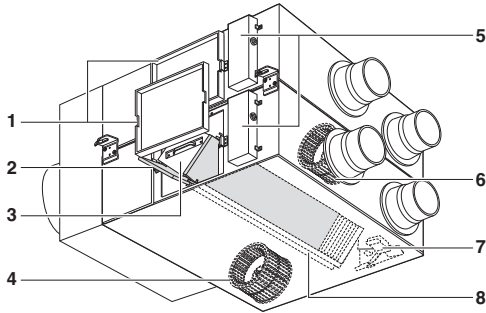

1. Maintenance cover

2. Air filter

It prevents dust from clogging in total heat exchanger.

3. Total heat exchanger

It changes temperature and humidity between supplying air and exhausted air.

4. Blower for exhaust air

It is a fan for discharging the contaminated air to outdoor.

5. Control box

6. Blower for supply air

It is a fan for inhaling exterior air into an indoor space.

7. Damper plate(board)

It converts exchanging mode between total heat ventilation and general ventilation.

8. Total heat exchanger holder

It is used in guiding for the installation of total heat exchanger.

※ The form of total heat exchanger varies according to models.

※ Optional filter(ISO ePM1 75 %) is available. It is sold separately.

Operating instructions (Accessory)

Name and function of remote controller

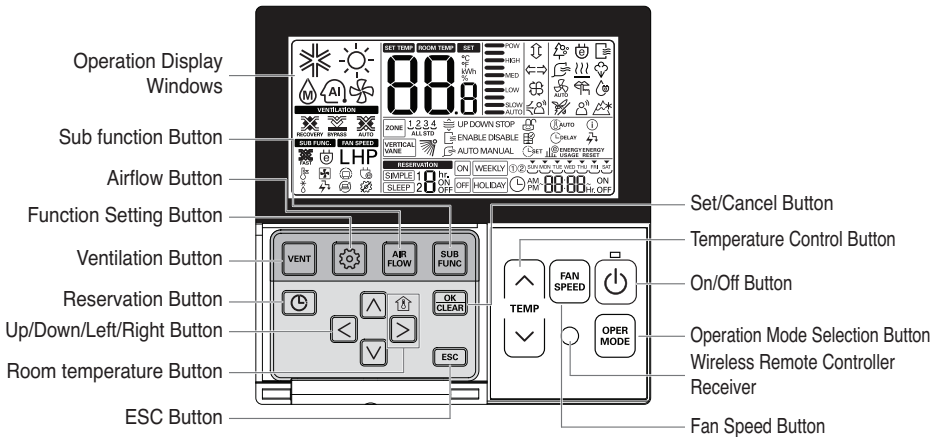

| | |
|--|---|
| Operation Display Windows | : Displays the status of operation and settings |
| Ventilation Button | : For interlocking operations of air-conditioner and ventilator |
| Function Setting Button | : To select the additional operations function |
| Airflow Button | : To select the airflows |
| Sub function Button | : To select the additional operations function |
| Reservation Button | : To program the schedule |
| Up/Down/Left/Right Button | : To change the settings in the menu |
| Room temperature Button | : To check the indoor temperature |
| ESC Button | : To exit from the menu |
| Set/Cancel Button | : To save the settings in the menu |
| Temperature Control Button | : To change the desired temperature |
| Fan Speed Button | : To select the fan speed |
| On/Off Button | : To turn on/off with a remote controller |
| Mode Selection Button | : To select the operating mode |
| Wireless Remote Controller Receiver | |

※ Some functions may not be operated and displayed depending on the product type.

※ It will display strange value to the room temperature if wired remote controller is not connected.

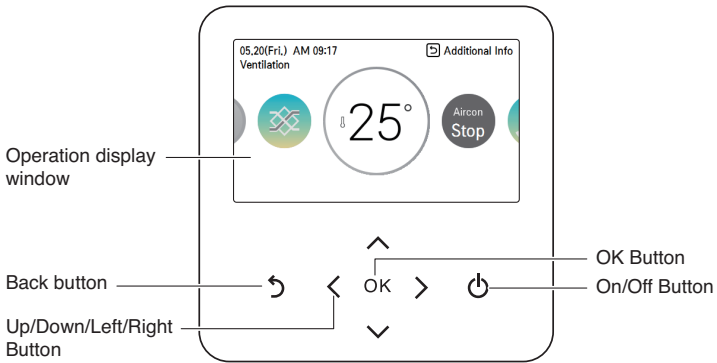

| | |
|----------------------------------|---|
| Operation display window | Operation and Settings status display |
| Back button | When you move to the previous stage from the menu's setting stage |
| Up/down/left/right button | When you change the menu's setting value |
| OK button | When you save the menu's setting value |
| On/Off button | When you turn ON/OFF the air conditioner |

* Some functions may not be operated and displayed depending on the product type.
 Refer to remote controller in order to know detail functions.

Method to operate and select air volume – Interlinked operation with ventilation

It is used when air conditioner is interlinked with ventilation product.

It is a function that cools and refreshes indoor air using the ventilation product at the same time operating the air conditioning function.

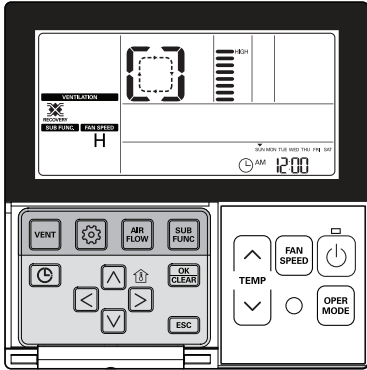

Ventilation interlinked operation

- 1** Press **VENT** button on the remote controller control panel.

- It is only used when air conditioner and general ventilation is interlinked.

- 2** Pressing 'Start/Stop' button at ventilation mode will start ventilation.
- 3** Pressing **OPER MODE** button will change the ventilation operation mode. Pressing operation selection button will change the mode in the order of 'heat exchange → normal → automatic'

※ It only displays on the remote controller display when it is in ventilation mode, and it displays the desired temperature when it returns to air condition mode.

- 4** Pressing **FAN SPEED** button in general ventilation mode will change airflow speed. Pressing airflow speed button will change the mode in the order of 'low → high → power'.

If CO₂ sensor is installed, it can select from 'low → high → power → auto'.

- 5** Changing back to air conditioner mode

 - 1) Automatic conversion : when no button is pressed for 15 seconds or longer, it automatically converts back to air conditioner mode.
 - 2) Manual conversion : pressing **VENT** button in ventilation mode will manually convert.

Method to operate and select air volume – Ventilation single operation

It is a function to cool and refresh the indoor air using general ventilation product.

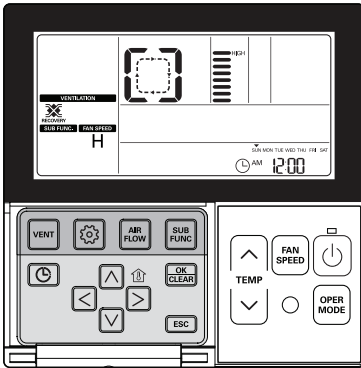



Ventilation single operation

1 Press  button on the remote controller.



2 Pressing  button will change the ventilation mode.



| Ventilation mode | Remote controller display | Contents |
|------------------|---|--|
| Heat exchange |  | Circulate indoor air without loss of heat |
| Normal |  | Directly circulate indoor air without going through heat exchanger |
| Automatic | AU | Circulate indoor air with automatically comparing indoor and outdoor air |

In the case of heat exchange mode, the display is shown as below.

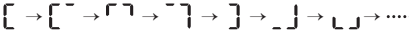

3 Pressing  button will change the strength of the wind



- Pressing the button can select from 'low → high → power'.
- If CO₂ sensor is installed, it can select from 'low → high → power → auto'.

Fast/energy saving ventilation mode

It is a function to operate ventilation function more efficiently through the ventilation additional functions, fast / power saving settings.

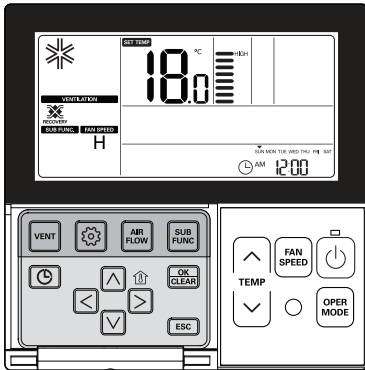

Fast : ventilates fast

- 1 Press **SUB FUNC** button in ventilation mode. - It converts in the order of 'fast' → 'power saving' in ventilation mode.



- 2 'Fast' is blinking on the display, and pressing **OK CLEAR** button will stabilize 'fast' icon, and the function is set.

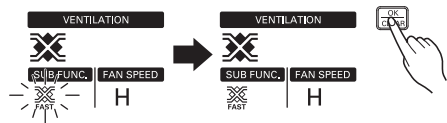

- 3 Pressing **ESC** button will exit the settings.



Power saving : efficiently ventilates and performs power savings.

- 1 Press **SUB FUNC** button in ventilation mode. - It converts in the order of 'fast' → 'power saving' in ventilation mode.



- 2 'Power saving' is blinking on the display, and pressing **OK CLEAR** button will stabilize 'power saving' icon, and the function is set.

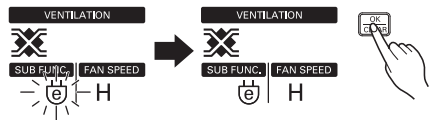

- 3 Pressing **ESC** button will exit the settings.



- * General ventilation and direct expansion ventilation have the same additional functions.
- * Ventilation/heater/humidifier additional function settings are the same as air conditioner.

Using add-ons

(Only for 200/150 CMH)

Check the overall cleanliness

- The indoor air quality is displayed so you can check the cleanliness.
- You can check the indoor cleanliness step by step.
- Dust concentrations are expressed as 4 $\mu\text{g}/\text{m}^3$ to 999 $\mu\text{g}/\text{m}^3$.
- The dust concentration can change continuously with changes in the indoor environment.
- If there is a lot of dust in the place where the product is installed, the displayed dust concentration and the actual concentration may differ significantly.
- Depending on the model, some functions may not be displayed/operated or may be different.
- Find out the concentration of fine dust by the color of the overall cleanliness of the indoor unit display part.
- The overall cleanliness is displayed in four colors under the main screen of the indoor unit display according to the concentration of fine dust.
- It is displayed based on items with high pollution levels among fine dust, ultra-fine dust, and ultra-fine dust.

Using UVnano Function

- UVnano is a compound word of UV (ultraviolet rays) and nanometer (length unit).
- This function reduces various bacteria inside the air conditioner.

NOTE

- UV is displayed on some indoor units, depending on the model.
- The UVnano function stops when the air conditioner is turned off.

| Color | Level | Display criteria | | |
|--------|----------|------------------------|------------------------|------------------|
| | | Microfine dust (PM1.0) | Ultrafine dust (PM2.5) | Fine dust (PM10) |
| Blue | Good | 15 below | 15 below | 30 below |
| Green | Normal | 16 ~ 35 | 16 ~ 35 | 31 ~ 80 |
| Orange | Bad | 36 ~ 75 | 36 ~ 75 | 81 ~ 150 |
| Red | Very bad | 76 above | 76 above | 151 above |

Characteristics

Ventilation via total heat exchanger

Exhausts indoor air via the total heat exchanger outdoor.

- The outdoor air heat exchanged is supplied to indoor. Operate the ventilator in the **ventilation via total heat exchanger** in summer/winter when cool/heat operation is done.

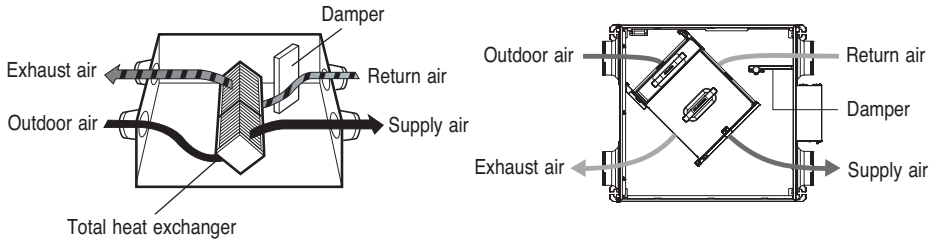

Normal ventilation

Exhausts the polluted indoor-air directly without via the total heat exchanger.

- Operate the ventilator in the **normal ventilation** in spring/autumn when the total heat exchanger is not required.

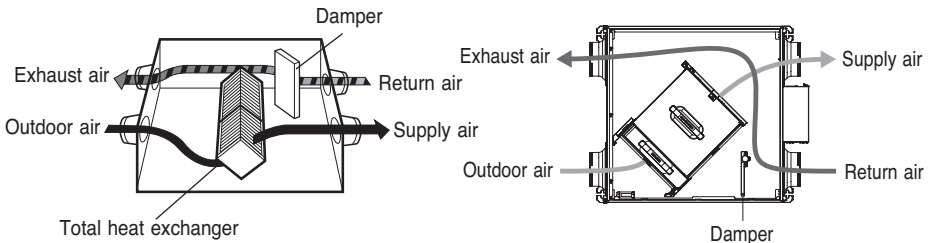

! CAUTION

In case of high outdoor pollution degree like yellow sand please pause the ventilator.

Maintenance and service

Handling and cleaning

To prevent function of the ventilator deteriorating, clean dust adhered to the air filter and total heat exchanger regularly.

Method to take each part out

⚠ CAUTION

Take care to ensure that you could not damage when taking the air filter out since there is a sharp part on it.

⚠ WARNING

Turn the breaker off when cleaning the product.

⚠ CAUTION

Gloves should be worn when doing the maintenance work.

• 150/200 CMH

1. Press the door button to open the access door.

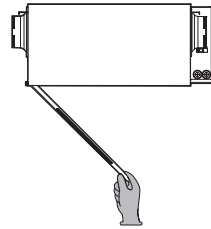

2. Take the pre-filter, fine filter out.

Take it out using the filter handle.
(2 pre-filters, Fine filter).

Make sure that the main power is turned off when removing the pre-filter as this is a model supporting UV LED. (UV exposure can cause injury.)

3. Take the total heat exchanger out.

Loosen the stopper screw hanging on the heat exchange element.

Pull the stopper in the same direction as in the picture.

Take it out using the handle of the heat exchange element.

When removing the stopper, hold it with your other hand so the heat exchange element does not fall.

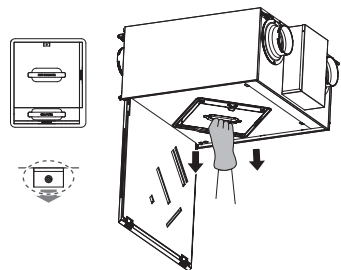

• 250 / 350 / 500 / 800 / 1 000 CMH

1. Remove the maintenance cover.

Loosen a screw on the maintenance cover.
Put the hands inside of the ceiling from the maintenance cover, and pull the maintenance cover up.
(Loosen the hinge and detach the maintenance cover.)

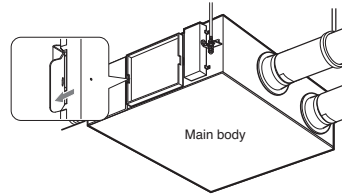

2. Take the air filter out.

Take the air filter with each contained to the left/right downside of the total heat exchanger.
* If it adheres to the ceiling in reverse, it is equal to the left/right topside of the total heat exchanger.

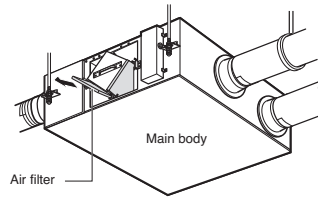

3. Take the total heat exchanger out.

Catch the handle and then take the total heat exchanger out from the main body. (2 units)

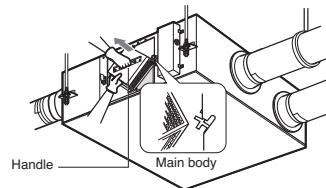

• 1 500 / 2 000 CMH

1. Remove the maintenance cover.

Loosen a screw on the maintenance cover.

Put the hands inside of the ceiling from the maintenance cover, and pull the maintenance cover up. (Loosen the hinge and detach the maintenance cover.)

2. Take the air filter out.

Take the air filter with each contained to the left/right downside of the total heat exchanger.

✱ If it adheres to the ceiling in reverse, it is equal to the left/right topside of the total heat exchanger.

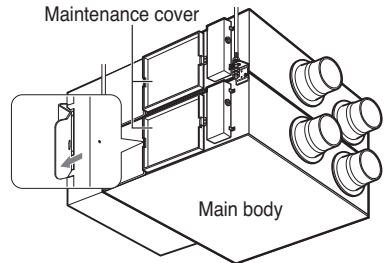

3. Take the total heat exchanger out.

Catch the handle and then take the total heat exchanger out from the main body. (4 units)

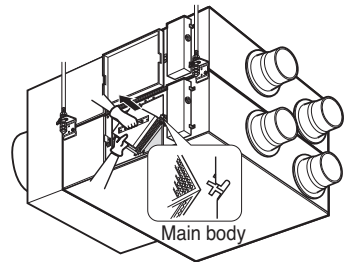

Method to clean and replace each part

1. Cleaning of air filter(pre-filter), fine filter.

- Clean dirt from the air filter using a vacuum cleaner or washing with water. (If dirt is conspicuous, wash with a neutral detergent in lukewarm water)
- After washing with water, dry well in the shade. (Do not expose the air filter to direct sunlight or heat from a fire when drying it)
- If the air filter is damaged, purchase it from the service center or professional agent.

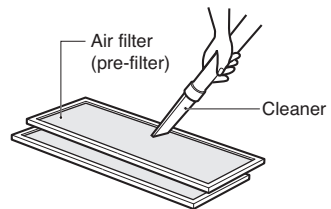

Clean once every 3 months

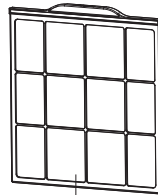

Air filter (Pre-filter)

Clean once every 3 months

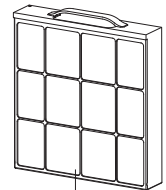

Fine filter

Clean once every 6 months

2. Cleaning of total heat exchanger

Suck dusts adhered to the surface of the total heat exchanger with a cleaner.

- Use the cleaner that attached to brush at its nozzle, and use a soft brush.
- Do not use a hard nozzle on the cleaner. (Otherwise, surface of the total heat exchanger may be damaged.)
- Never wash the total heat exchanger with water.
- Replacement expenses are for a consideration after 1 years from the purchasing date.
- Expenses are for a consideration when you will contact the service center even within 1 years from the purchasing date.
- For service, always contact the dealer or an authorized service center.



Air filter



Total heat exchanger

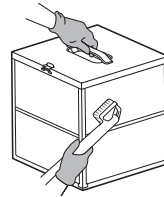
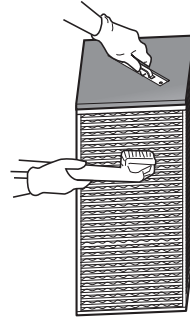

Clean once every 12 months

Assembly and check after maintenance

⚠ WARNING

Turn the breaker off when cleaning the product.

⚠ CAUTION

Gloves should be worn when doing the maintenance work.

• 150/200 CMH

1. Assembly of total heat exchanger / air filter(2 pre-filters, Fine filter).

Put the total heat exchange element, pre-filter and Fine filter into the product, then fill in the fall prevention safety device and tighten the screw.

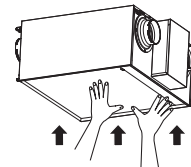
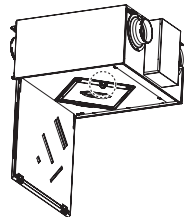

2. Assembly of maintenance cover

Close the access door after checking that the total heat exchange element and filter are properly installed.

• 250 / 350 / 500 / 800 / 1 000 CMH

1. Assembly of total heat exchanger

Securely put the corner parts (4 parts) of the total heat exchanger into the holder for assembly and slide them into the inside of the main body.

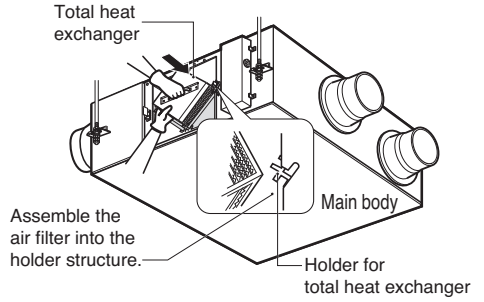

2. Assembly of air filter

Assemble the air filter into the holder structure of the total heat exchanger.

- Take care to ensure that surface of the total heat exchanger could not be damaged.
- Dusts adhered to the total heat exchanger may cause deterioration of air volume.

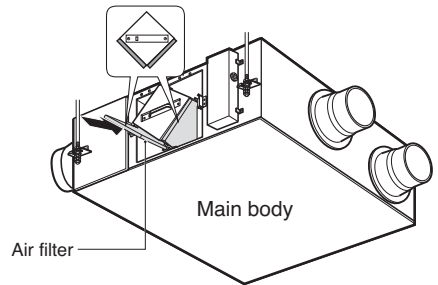



3. Assembly of maintenance cover

Fix the cover to the right hinge and fix it to the left side. (A nameplate is adhered toward the reading direction).

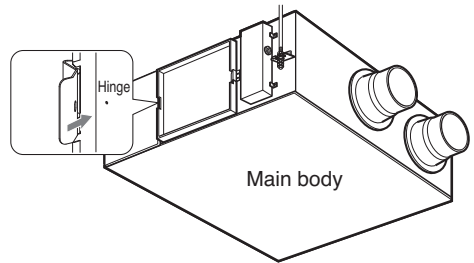
Tighten a screw on the maintenance cover.



Check item prior to notify a failure

| Symptom | Check Item | Counter-measure |
|---|---|--|
| The Product doesn't work | Is power not supplied? | Supply Power |
| The Product doesn't work through you press the 'ON' switch | Is the Indoor temperature less than 15 °C or more than 40 °C? | It's standby mode for protecting Total Heat Exchanger. |
| Even though you change the fan speed, the operation mode doesn't change and it changes to 'Auto or Low' | Is the Indoor temperature less than -10 °C or more than 45 °C? | It's operation mode to protect Total Heat Exchanger. |
| Even though you push the button of remote controller, any function doesn't work. | Is the icon "  " displaying on remote controller? | It's Child Lock mode. Refer to Remote controller. |
| | Is the icon "  " displaying on remote controller? Does the message "HL" display on remote controller when you push the button. | It's centralized control mode. You can't control on remote controller. |