





















# MULTISPLIT



# MULTISPLIT INVERTER

OUTDOOR UNIT R32 MULTISPLIT			1:2		1:3		1:4		1:5		
			2U40S2SM1FA	2U50S2SM1FA-3	3U55S2SR5FA	3U70S2SR5FA	4U75S2SR5FA	4U85S2SR5FA	5U90S2SS5FA	5U105S2SS5FA	5U125S2SN1FA
INDOOR UNIT R32		kW	4,0 kW	5,0 kW	5,5 kW	7,0 kW	7,5 kW	8,5 kW	9,0 kW	10,5 kW	12,5 kW
 <b>JADE</b>	AS25S2SJ1FA-3	2,5	●	●	●	●	●	●	●	●	●
	AS35S2SJ1FA-3	3,5	●	●	●	●	●	●	●	●	●
	AS50S2SJ1FA-3	5,0			●	●	●	●	●	●	●
 <b>EXPERT</b>	AS20XCAHRA	2,0	●	●	●	●	●	●	●	●	●
	AS25XCAHRA	2,5	●	●	●	●	●	●	●	●	●
	AS35XCAHRA	3,5	●	●	●	●	●	●	●	●	●
	AS50XCAHRA	5,0			●	●	●	●	●	●	●
 <b>NEW EXPERT BLACK</b>	AS20XCAHRA-MB	2,0	●	●	●	●	●	●	●	●	●
	AS25XCAHRA-MB	2,5	●	●	●	●	●	●	●	●	●
	AS35XCAHRA-MB	3,5	●	●	●	●	●	●	●	●	●
	AS50XCAHRA-MB	5,0			●	●	●	●	●	●	●
 <b>FLEXIS PLUS BLACK</b>	AS20S2SF1FA-MB3	2,0	●	●	●	●	●	●	●	●	●
	AS25S2SF1FA-MB3	2,5	●	●	●	●	●	●	●	●	●
	AS35S2SF1FA-MB3	3,5	●	●	●	●	●	●	●	●	●
	AS50S2SF1FA-MB3	5,0			●	●	●	●	●	●	●
	AS71S2SF1FA-MB3	7,1				●	●	●	●	●	●
 <b>FLEXIS PLUS WHITE</b>	AS20S2SF1FA-MW3	2,0	●	●	●	●	●	●	●	●	●
	AS25S2SF1FA-MW3	2,5	●	●	●	●	●	●	●	●	●
	AS35S2SF1FA-MW3	3,5	●	●	●	●	●	●	●	●	●
	AS50S2SF1FA-MW3	5,0			●	●	●	●	●	●	●
	AS71S2SF1FA-MW3	7,1				●	●	●	●	●	●
 <b>PEARL</b>	AS20PBAHRA	2,0	●	●	●	●	●	●	●	●	●
	AS25PBAHRA	2,5	●	●	●	●	●	●	●	●	●
	AS35PBAHRA	3,5	●	●	●	●	●	●	●	●	●
	AS50PBAHRA	5,0			●	●	●	●	●	●	●
	AS68PDAHRA	6,8				●	●	●	●	●	●
 <b>CONSOLE</b>	AF25S2SD1FA(D)	2,5			●	●	●	●	●	●	●
	AF35S2SD1FA(D)	3,5			●	●	●	●	●	●	●
	AF42S2SD1FA(D)	4,2			●	●	●	●	●	●	●
 <b>CASSETTE 620</b>	AB25S2SC2FA(H)	2,5			●	●	●	●	●	●	●
	AB35S2SC2FA(H)	3,5			●	●	●	●	●	●	●
	AB50S2SC2FA(H)	5,0			●	●	●	●	●	●	●
 <b>CASSETTE ROUND FLOW</b>	AB71S2SG1FA(H)	7,1				●	●	●	●	●	
 <b>CEILING FLOOR</b>	AC35S2SG1FA(H)	3,5			●	●	●	●	●	●	●
	AC50S2SG1FA(H)	5,0			●	●	●	●	●	●	●
	AC71S2SG1FA(H)	7,1				●	●	●	●	●	●
 <b>SLIM DUCT LOW PRESSURE</b>	AD25S2SS1FA(H)	2,5			●	●	●	●	●	●	●
	AD35S2SS1FA(H)	3,5			●	●	●	●	●	●	●
	AD50S2SS1FA(H)	5,0			●	●	●	●	●	●	●
	AD71S2SS1FA(H)	7,1				●	●	●	●	●	●
 <b>DUCTED MEDIUM PRESSURE</b>	AD35S2SM3FA(H)	3,5			●	●	●	●	●	●	●
	AD50S2SM3FA(H)	5,0			●	●	●	●	●	●	●
	AD71S2SM3FA(H)	7,1				●	●	●	●	●	●

# MULTISPLIT INVERTER

OUTDOOR UNITS MULTISPLIT R32								
4,0 kW	5,0 kW	5,5 Kw	7,0 kW	7,5 kW	8,5 kW	9,0 kW	10,5 kW	12,5kW
1:2		1:3		1:4		1:5		
								
2U40S2SM1FA	2U50S2SM1FA-3	3U55S2SR5FA	3U70S2SR5FA	4U75S2SR5FA	4U85S2SR5FA	5U90S2SS5FA	5U105S2SS5FA	5U125S2SN1FA
Self-clean								

### COMPATIBLE UNITS 1:2

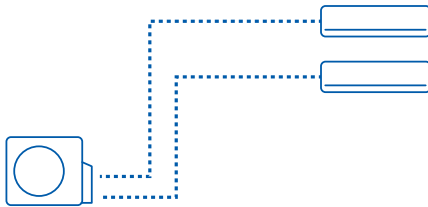

Wall = Wall Only

### COMPATIBLE UNITS 1:3

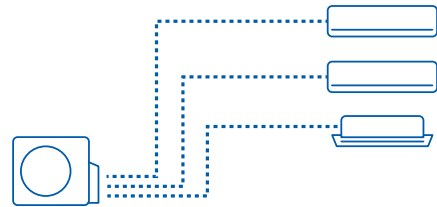

Wall - Cassettes - Floor Ceiling - Console - Ducted

### COMPATIBLE UNITS 1:4

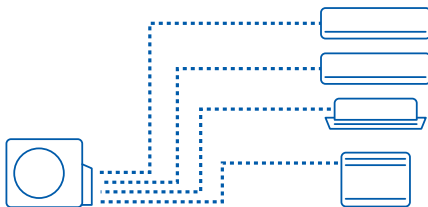

Wall - Cassettes - Floor Ceiling - Console - Ducted

### COMPATIBLE UNITS 1:5

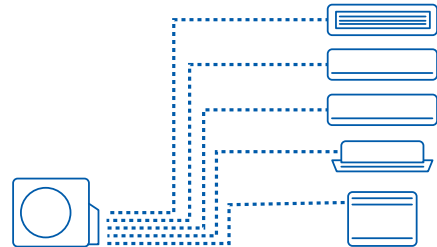

Wall - Cassettes - Floor Ceiling - Console - Ducted

# MultiSplit OUTDOOR UNITS

# Haier

MULTISPLIT



**1:2** 2U40S2SM1FA  
2U50S2SM1FA-3



**1:3** 3U55S2SR5FA  
3U70S2SR5FA



**1:4** 4U75S2SR5FA  
4U85S2SR5FA



**1:5** 5U90S2SS5FA  
5U105S2SS5FA  
5U125S2SN1FA

4,0 kW

5,0 kW

5,5 Kw

7,0 kW

7,5 kW

8,5 kW

9,0 kW

10,5 kW

12,5 kW

Outdoor UNIT	Model		2U40S2SM1FA	2U50S2SM1FA-3	3U55S2SR5FA	3U70S2SR5FA	4U75S2SR5FA	4U85S2SR5FA	5U90S2SS5FA	5U105S2SS5FA	5U125S2SN1FA
<b>Performance data</b>											
Output power - COOLING	nom (min-max)	kW	4,00 (1,00-4,50)	5,00 (1,10-5,60)	5,50 (2,10-7,00)	7,00 (2,40-7,60)	7,50 (2,40-8,70)	8,50 (3,20-9,50)	9,00 (3,20-11,00)	10,00 (3,20-11,00)	12,50 (3,20-13,80)
Output power - HEATING	nom (min-max)	kW	4,40 (1,50-4,80)	5,20 (1,40-6,00)	6,80 (1,70-7,60)	7,60 (2,90-8,50)	8,60 (3,10-10,00)	9,60 (4,40-10,50)	10,40 (4,40-11,50)	10,50 (4,40-11,50)	12,70 (4,40-14,30)
Absorbed power - COOLING	nom	kW	1,00	1,43	1,35	1,84	1,97	2,50	2,79	3,47	3,87
Absorbed power - HEATING	nom	kW	1,07	1,40	1,66	1,85	2,15	2,40	2,79	2,82	3,40
Energy class	EER	W/W	4,00	3,45	4,00	3,81	3,80	3,40	3,23	2,88	3,23
	COP	W/W	4,10	3,71	4,10	4,10	4,00	4,00	3,73	3,73	3,73
COOLING Pdesign	35 °C	kW	4,00	5,00	5,50	7,00	7,50	8,00	9,00	10,00	12,50
HEATING Pdesign	(-10 °C)	kW	3,30	4,70	4,70	6,00	6,30	7,00	7,20	8,00	9,50
Energy class	SEER		6,50 (A++)	6,50 (A++)	8,50 (A+++)	7,50 (A++)	7,00 (A++)	7,00 (A++)	7,00 (A++)	7,00 (A++)	7,10 (A++)
	SCOP		4,00 (A+)	4,00 (A+)	4,00 (A+)	4,20 (A+)	4,00 (A+)	4,00 (A+)	4,00 (A+)	4,00 (A+)	4,05 (A+)
Annual Energy Consumption - COOLING		kWh/a	269	269	227	332	379	456	457	537	622
Annual Energy Consumption - HEATING		kWh/a	1645	1645	1678	2012	2179	2503	2441	2889	3346
<b>Outdoor unit</b>											
Power supply		Ph/V/Hz	1/220-240/50/60								
Power cable		N x mm <sup>2</sup>	3 x 2,5	3 x 2,5	3 x 4,0	3 x 4,0	3 x 4,0	3 x 4,0	3 x 4,0	3 x 4,0	3 x 4,0
Interconnection cable		N x mm <sup>2</sup>	4 x 1,0	4 x 1,0	4 x 2,5	4 x 2,5	4 x 2,5	4 x 2,5	4 x 2,5	4 x 2,5	4 x 2,5
Air volume	H	m <sup>3</sup> /h	2200	2400	3000	3000	4000	4000	4200	4200	4200
Sound power	H	dB	62	63	64	66	68	68	70	70	73
Sound pressure	H	dB(A)	52	53	51	53	55	55	55	55	58
Running current cooling/heating	Max	A	7,3/8,2	9,1/9,1	10,8/9,5	11,9/9,7	14,7/13,5	15,5/14,6	18,2/14,6	18,2/14,6	23,0/18,7
Starting current cooling/heating	Max	A	3,0/3,0	3,0/3,0	4,0/4,0	4,0/4,0	5,0/5,0	5,0/5,0	5,0/5,0	5,0/5,0	5,0/5,0
Net dimensions	WxDxH	mm	800x275x553	800x275x553	890x340x700	890x340x700	890x340x700	890x340x700	920x372x765	920x372x765	950x370x965
Packaging dimensions	WxDxH	mm	954x409x625	954x409x625	1010x455x835	1010x455x835	1010x455x835	1010x455x835	1045x488x890	1045x488x890	1050x485x1170
Net/gross weight		kg	34,0/37,0	36,0/39,0	50,0/59,0	54,0/63,0	61,0/70,0	61,0/70,0	66,0/77,0	66,0/77,0	79,0/91,0
Compressor type			Twin Rotary Inverter								
<b>Installation data</b>											
Refrigerant			R32	R32	R32	R32	R32	R32	R32	R32	R32
Liquid pipe	Ø	mm (inch)	2×6,35 (3x1/4)	2×6,35 (3x1/4)	3×6,35 (3x1/4)	3×6,35 (3x1/4)	4×6,35 (4x1/4)	4×6,35 (4x1/4)	5×6,35 (5x1/4)	5×6,35 (5x1/4)	5×6,35 (5x1/4)
Gas pipe	Ø	mm (inch)	2×9,52 (3x3/8)	2×9,52 (3x3/8)	3×9,52 (3x3/8)	3×9,52 (3x3/8)	3×9,52+1×12,70 (3x3/8+1x1/2)	3×9,52+1×12,70 (3x3/8+1x1/2)	3×9,52+2×12,70 (3x3/8+2x1/2)	3×9,52+2×12,70 (3x3/8+2x1/2)	3×9,52+2×12,70 (3x3/8+2x1/2)
Standard pipe length without refrigerant charge		m	20	20	30	30	40	40	40	40	50
Maximum pipe length		m	30	30	50	60	70	70	80	80	100
Maximum IU - OU elevation		m	15	15	15	15	15	15	15	15	15
Maximum IU - IU elevation		m	7,5	7,5	7,5	7,5	7,5	7,5	7,5	7,5	7,5
Refrigerant charge in the factory		kg	1,00	1,40	1,40	1,60	1,60	2,20	2,40	2,40	2,50
Refrigerant charge in the factory		TCO <sub>2</sub> eq	0,68	0,95	0,95	1,08	1,08	1,49	1,62	1,62	1,69
Additional ref. charge over std length		g/m	20	20	20	20	20	20	20	20	20
Operating limits - COOLING	min-max	°C	-10~43°C				-10~46°C				
Operating limits - HEATING	min-max	°C	-15~24°C								

The data in this catalogue is purely indicative as the data may vary. Please be advised to check the accuracy of the data with the supplier before purchasing products.

2,5 kW

3,5 kW

5,0 kW



Standard HQ-HJ

# JADE



Silence



Wi-Fi control integrated



Easy Installation



3D

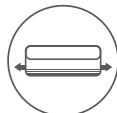

2-Way Piping Design



Self Hygiene



Puri Clean



I Feel

- Self-Clean (Only Dual)
- Low noise level
- Wi-Fi control integrated
- Easy installation

- 3D airflow: continuous movement of horizontal and vertical deflectors
- 2-way Piping design
- 56°C Steri-Clean

- Self-Hygiene
- Puri Clean
- I feel

Indoor Unit	Model		AS25S2SJ1FA-3	AS35S2SJ1FA-3	AS50S2SJ1FA-3
<b>Performance data</b>					
Output power - COOLING	nom (min-max)	kW	2,60 (1,00-4,00)	3,50 (1,00-4,00)	5,20 (1,40-6,00)
Output power - HEATING	nom (min-max)	kW	3,20 (1,10-5,40)	4,20 (1,30-5,80)	6,00 (1,40-6,90)
Power supply		Ph/V/Hz	1/220-240/50	1/220-240/50	1/220-240/50
Interconnection cable			4 x 1,0	4 x 1,0	4 x 1,0
Treated air volume	H	m <sup>3</sup> /h	550	600	900
<b>Indoor Unit</b>					
High sound power - COOLING		dB	56	57	57
High sound power - HEATING		dB	56	57	57
Sound pressure - COOLING		dB(A)	36/32/29/15	37/33/30/16	41/37/33/28
Sound pressure -HEATING		dB(A)	36/32/29/15	37/33/30/16	41/37/33/28
Net dimensions	WxDxH	mm	923x215x320	923x215x320	1050x235x350
Packaging dimensions	WxDxH	mm	1032x318x418	1032x318x418	1160x347x455
Net/gross weight		kg	12,0/15,2	12,0/15,2	14,9/18,9
<b>Installation data</b>					
Liquid pipe	∅	mm	6,35 (1/4)	6,35 (1/4)	6,35 (1/4)
Gas pipe	∅	mm	9,52 (3/8)	9,52 (3/8)	12,70 (1/2)
<b>Control</b>					
Standard	Remote control		HQ-HJ	HQ-HJ	HQ-HJ

AS25 - AS35

AS50

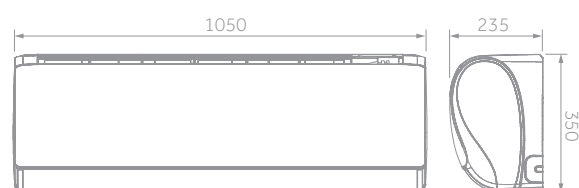
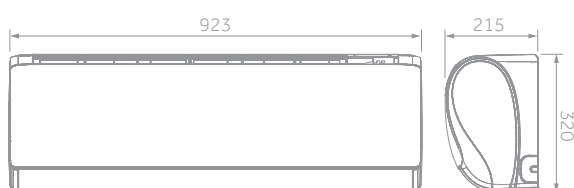

# EXPERT NEW



2,0 kW

2,5 kW

3,5 kW

5,0 kW



Standard HQ-HJ



Easy Installation



I Feel

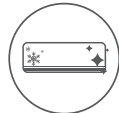

Self Clean



Coanda Plus



Eco Sensor

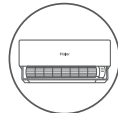

Easy to Disassemble

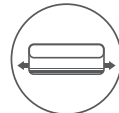

2-Way Piping Design



UVC Pro



Wi-Fi control integrated

- Easy Installation
- I feel
- Self-Clean (Only Dual)
- Eco Sensor
- On-Off Card
- 2-Way Pipe Design
- UVC Pro
- Wi-Fi control integrated

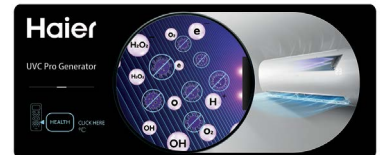

Indoor Unit	Model	AS20XCAHRA		AS25XCAHRA		AS35XCAHRA		AS50XCAHRA	
			AS20XCAHRA-MB		AS25XCAHRA-MB		AS35XCAHRA-MB		AS50XCAHRA-MB
<b>Performance data</b>									
Output power - COOLING	nom (min-max)	kW	2,00	2,80 (0,80-3,20)	3,50 (1,00-4,00)	5,00 (1,40-5,50)			
Output power - HEATING	nom (min-max)	kW	2,50	3,20 (0,80-4,20)	4,20 (1,00-5,20)	5,60 (1,70-6,20)			
Power supply		Ph/V/Hz	1/220-240/50	1/220-240/50	1/220-240/50	1/220-240/50			
Interconnection cable			4 x 1,0	4 x 1,0	4 x 1,0	4 x 1,0			
Treated air volume	H	m3/h	730	730	800	880			
<b>Indoor Unit</b>									
High sound power - COOLING		dB	56	56	57	60			
High sound power - HEATING		dB	56	56	57	60			
Sound pressure - COOLING		dB(A)	39/32/25/16	39/32/25/16	40/33/26/17	45/37/29/20			
Sound pressure - HEATING		dB(A)	39/32/25/16	39/32/25/16	40/33/26/17	45/37/29/20			
Net dimensions	WxDxH	mm	895x313x236	895x313x236	895x313x236	895x313x236			
Packaging dimensions	WxDxH	mm	964x386x316	964x386x316	964x386x316	964x386x316			
Net/gross weight		kg	11,3/14,0	11,3/14,0	11,3/14,0	11,6/14,2			
<b>Installation data</b>									
Liquid pipe	Ø	mm	6,35 (1/4)	6,35 (1/4)	6,35 (1/4)	6,35 (1/4)			
Gas pipe	Ø	mm	9,52 (3/8)	9,52 (3/8)	9,52 (3/8)	12,70 (1/2)			
<b>Control</b>									
Standard	Remote control		HQ-HJ	HQ-HJ	HQ-HJ	HQ-HJ			

AS20 - AS25 - AS35 - AS50

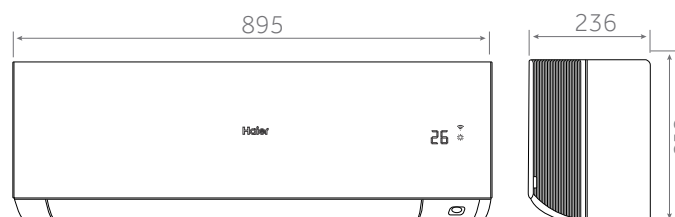

# FLEXIS PLUS White & Black

2,0 kW

2,5 kW

3,5 kW

5,0 kW

7,0 kW



Standard HQ-HJ



Silence



Eco Sensor



Wi-Fi control integrated



3D



Easy Installation



UVC Sterilisation



I Feel

- Low noise level
- Dual motion sensor
- Wi-Fi control integrated
- 3D airflow: continuous movement of horizontal and vertical deflectors

- Easy installation
- UVC Sterilisation
- I feel

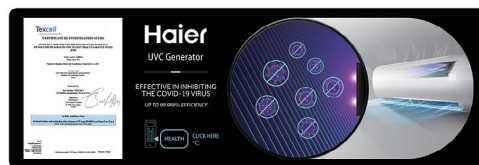

Indoor Unit	Model	AS20S2SF1FA-MW3		AS25S2SF1FA-MW3		AS35S2SF1FA-MW3		AS50S2SF1FA-MW3		AS71S2SF1FA-MW3	
		AS20S2SF1FA-MB3		AS25S2SF1FA-MB3		AS35S2SF1FA-MB3		AS50S2SF1FA-MB3		AS71S2SF1FA-MB3	
<b>Performance data</b>											
Output power - COOLING	nom (min-max)	kW	2,00	2,60 (0,80-3,20)	3,50 (1,00-4,00)	5,20 (1,40-6,00)	7,00 (2,20-7,50)				
Output power - HEATING	nom (min-max)	kW	2,50	3,20 (0,80-4,20)	4,20 (1,00-5,20)	6,00 (1,40-6,90)	8,00 (2,40-8,50)				
Power supply		Ph/V/Hz	1/220-240/50		1/220-240/50		1/220-240/50		1/220-240/50		1/220-240/50
Interconnection cable			4 x 1,0		4 x 1,0		4 x 1,0		4 x 1,0		4 x 1,0
Treated air volume	H	m3/h	600	600	650	900	1100				
<b>Indoor Unit</b>											
High sound power - COOLING		dB	53	53	55	57	60				
High sound power - HEATING		dB	53	53	55	57	60				
Sound pressure - COOLING		dB(A)	38/32/25/16	38/32/25/16	39/33/26/17	45/41/37/28	47/43/37/33				
Sound pressure -HEATING		dB(A)	38/32/25/19	38/32/25/19	39/33/26/20	45/41/37/28	47/43/37/33				
Net dimensions	WxDxH	mm	856x197x300	856x197x300	856x197x300	999x225x323	1115x235x343				
Packaging dimensions	WxDxH	mm	952x283x389	952x283x389	952x283x389	1100x314x420	1202x319x432				
Net/gross weight		kg	9,5/12,0	9,5/12,0	9,5/12,0	12,0/15,0	15,2/18,2				
<b>Installation data</b>											
Liquid pipe	∅	mm	6,35 (1/4)	6,35 (1/4)	6,35 (1/4)	6,35 (1/4)	9,52 (3/8)				
Gas pipe	∅	mm	9,52 (3/8)	9,52 (3/8)	9,52 (3/8)	12,70 (1/2)	15,88 (5/8)				
<b>Control</b>											
Standard	Remote control		HQ-HJ	HQ-HJ	HQ-HJ	HQ-HJ	HQ-HJ				

AS20 - AS25 - AS35

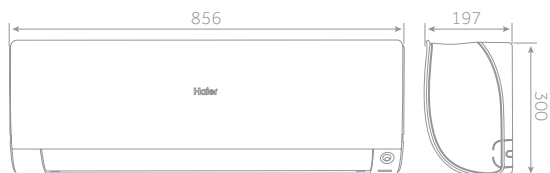

AS71

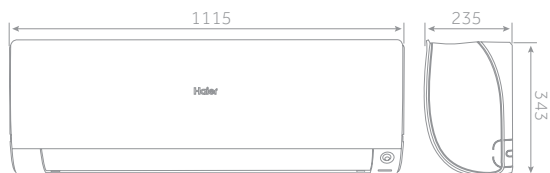

AS50

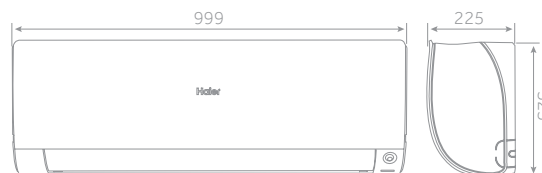

MOUNTING DIMENSIONS

AS20-AS25-AS35-AS50

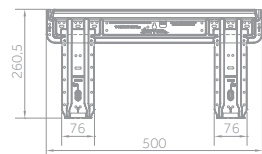

AS71

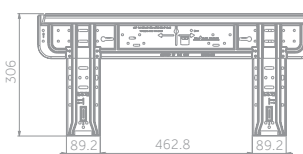

2,0 kW

2,5 kW

3,5 kW

5,0 kW

6,8 kW

# PEARL



Standard YR-HE



Silence



Self Clean



Wi-Fi control integrated



UVC Sterilisation



Easy Installation



Coanda Plus

- Low noise level
- Self-Clean (Only Dual)
- Wi-Fi control integrated
- UVC Sterilisation
- Easy installation
- Coanda plus airflow



Indoor Unit	Model		AS20PBAHRA	AS25PBAHRA	AS35PBAHRA	AS50PDAHRA	AS68PDAHRA
<b>Performance data</b>							
Output power - COOLING	nom (min-max)	kW	2,00	2,60 (0,80-3,00)	3,20 (0,80-3,60)	5,00 (1,30-5,80)	6,80 (2,20-8,50)
Output power - HEATING	nom (min-max)	kW	2,50	2,80 (0,80-3,20)	3,40 (0,80-4,20)	5,20 (1,40-6,00)	6,80 (2,40-9,50)
Power supply		Ph/V/Hz	1/220-240/50	1/220-240/50	1/220-240/50	1/220-240/50	1/220-240/50
Interconnection cable			4 x 1,0	4 x 1,0	4 x 1,0	4 x 1,0	4 x 1,0
Treated air volume	H	m3/h	550	550	600	900	1100
<b>Indoor Unit</b>							
High sound power - COOLING		dB	54	54	56	57	62
High sound power - HEATING		dB	54	54	56	57	62
Sound pressure - COOLING		dB(A)	37/32/28/18	37/32/28/18	37/33/29/19	44/40/35/28	47/45/37/29
Sound pressure - HEATING		dB(A)	37/32/28/18	37/32/28/18	37/33/29/19	44/40/35/28	47/45/37/29
Net dimensions	WxDxH	mm	805x200x290	805x200x290	805x200x290	975x220x320	975x220x320
Packaging dimensions	WxDxH	mm	874x270x363	874x270x363	874x270x363	1050x301x397	1050x301x397
Net/gross weight		kg	8,3/10,5	8,3/10,5	8,3/10,5	11,6/14,4	11,6/14,4
<b>Installation data</b>							
Liquid pipe	∅	mm	6,35 (1/4)	6,35 (1/4)	6,35 (1/4)	6,35 (1/4)	6,35 (1/4)
Gas pipe	∅	mm	9,52 (3/8)	9,52 (3/8)	9,52 (3/8)	12,70 (1/2)	12,70 (1/2)
<b>Control</b>							
Standard	Remote control		YR-HE	YR-HE	YR-HE	YR-HE	YR-HE

AS20 - AS25 - AS35



AS50 - AS68





2,5 kW

3,5 kW

4,2 kW



Standard YR-HQS01

## NEW CONSOLE



Silence



Double Flow



Sleep



Wi-Fi control integrated



R32 Detector

- Low noise level
- Double airflow
- Compact design

- Sleep function for greater night time comfort
- Wi-Fi control integrated
- R32 Detector

Indoor Unit	Model		AF25S2SD1FA(D)	AF35S2SD1FA(D)	AF42S2SD1FA(D)
<b>Performance data</b>					
Output power - COOLING	nom (min-max)	kW	2,50	3,40	4,20
Output power - HEATING	nom (min-max)	kW	3,00	3,50	4,70
Power supply		Ph/V/Hz	1/220~240/50/60	1/220~240/50/60	1/220~240/50/60
Treated air volume	(H/M/L/Q)	m <sup>3</sup> /h	450/400/350/300/250	500/450/400/350/300	580/530/480/430/380
<b>Indoor Unit</b>					
High sound power		dB	52	55	58
Sound pressure		dB(A)	40/32/25/20	42/34/26/21	46/37/33/28
Net dimensions	WxDxH	mm	700x210x600	700x210x600	700x210x600
Packaging dimensions	WxDxH	mm	783x303x695	783x303x695	783x303x695
Net/gross weight		kg	16,5/18,5	16,5/18,5	16,5/18,5
<b>Installation data</b>					
Liquid pipe	Ø	mm (inch)	6,35 (1/4)	6,35 (1/4)	6,35 (1/4)
Gas pipe	Ø	mm (inch)	9,52 (3/8)	9,52 (3/8)	9,52 (3/8)

### AF25 - AF35 - AF42

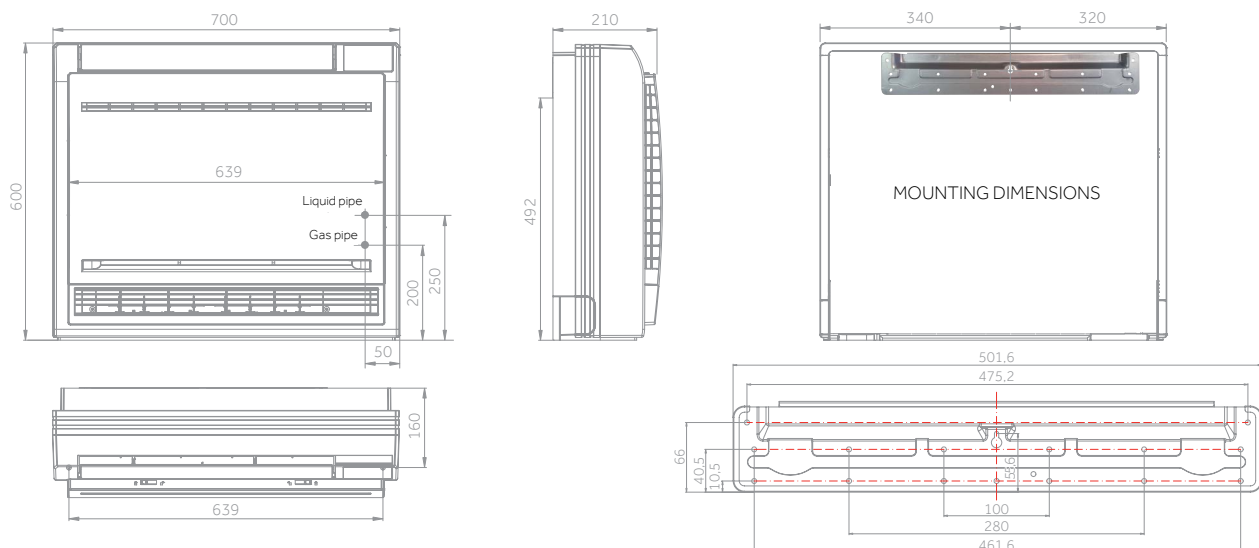

# CASSETTE 620 NEW

Haier

2,5 kW

3,5 kW

5,0 kW

OPTIONAL CONTROL

MULTISPLIT



Silence



4way Independent



Wi-Fi control integrated



UVC Sterilisation

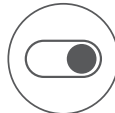

On-Off Card



Fresh Air



- Low noise level
- Wi-Fi control integrated
- UVC Sterilisation
- On-Off card
- 'Fresh air' knockout is incorporated in the chassis to allow fresh air introduction of up to 20% of nominal unit air flow without compromising the cooling capacity. More than 20% of the air conditioner's thermal cooling capacity is penalised.

Indoor Unit	Model		AB25S2SC2FA(H)	AB35S2SC2FA(H)	AB50S2SC2FA(H)
<b>Performance data</b>					
Output power - COOLING	nom (min-max)	kW	2,60	3,50	5,00
Output power - HEATING	nom (min-max)	kW	3,20	4,00	5,50
Power supply		Ph/V/Hz	1/220-240/50/60	1/220-240/50/60	1/220-240/50/60
Treated air volume	(H/M/L/Q)	m3/h	510/450/390/330	620/520/450/350	700/620/500/400
<b>Indoor Unit</b>					
High sound power		dB	50	52	55
Sound pressure		dB(A)	31/28/25/23	36/33/30/27	42/37/35/32
Net dimensions	WxDxH	mm	570x570x260	570x570x260	570x570x260
Packaging dimensions	WxDxH	mm	718x680x380	718x680x380	718x680x380
Net/gross weight		kg	17,0/20,5	18,5/22,0	19,0/22,0
<b>Installation data</b>					
Liquid pipe	Ø	mm (inch)	6,35 (1/4)	6,35 (1/4)	6,35 (1/4)
Gas pipe	Ø	mm (inch)	9,52 (3/8)	9,52 (3/8)	12,70 (1/2)
Panel	Model		PB-620KB(H)	PB-620KB(H)	PB-620KB(H)
Panel Net dimensions	WxDxH	mm	620x620x60	620x620x60	620x620x60
Panel Packaging dimensions	WxDxH	mm	660x660x115	660x660x115	660x660x115
Panel Net/gross weight		kg	2,8/4,5	2,8/4,5	2,8/4,5

AB25 - AB35 - AB50

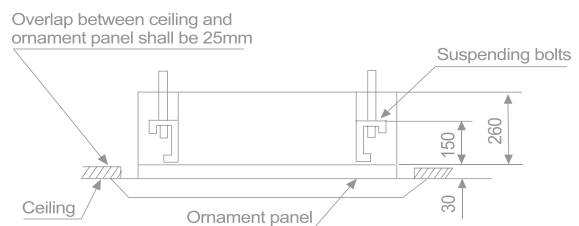
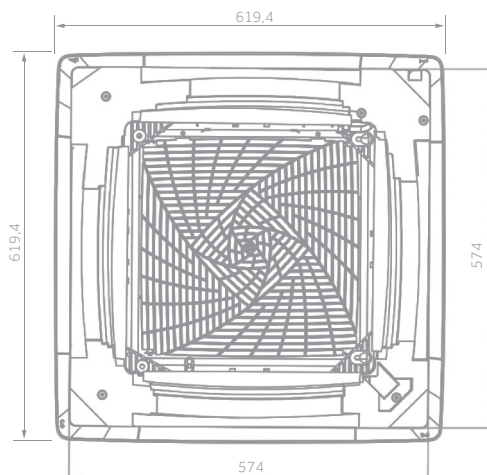

7,1 kW

OPTIONAL CONTROL



Silence



8way Independent



Wi-Fi control integrated



UVC Sterilisation



Fresh Air

- Low noise level
- 8 ways airflow
- Wi-Fi control integrated
- UVC Sterilisation
- 'Fresh air' knockout is incorporated in the chassis to allow fresh air introduction of up to 20% of nominal unit air flow without compromising the cooling capacity. More than 20% of the air conditioner's thermal cooling capacity is penalised.

Indoor Unit	Model		AB71S2SG1FA(H)
<b>Performance data</b>			
Output power - COOLING	nom (min-max)	kW	7,10
Output power - HEATING	nom (min-max)	kW	8,00
Power supply		Ph/V/Hz	1/220~240/50/60
Treated air volume	(H/M/L/Q)	m3/h	1260/1070/820/680
<b>Indoor Unit</b>			
High sound power		dB	55
Sound pressure		dB(A)	42/40/38/35
Net dimensions	WxDxH	mm	840x840x204
Packaging dimensions	WxDxH	mm	990x990x310
Net/gross weight		kg	27,0/32,0
<b>Installation data</b>			
Liquid pipe	Ø	mm (inch)	9,52 (3/8)
Gas pipe	Ø	mm (inch)	15,88 (5/8)
Panel	Model		PB-950KB(H)
Panel Net dimensions	WxDxH	mm	950x950x50
Panel Packaging dimensions	WxDxH	mm	1013x1025x123
Panel Net/gross weight		kg	6,5/9,5

AB71

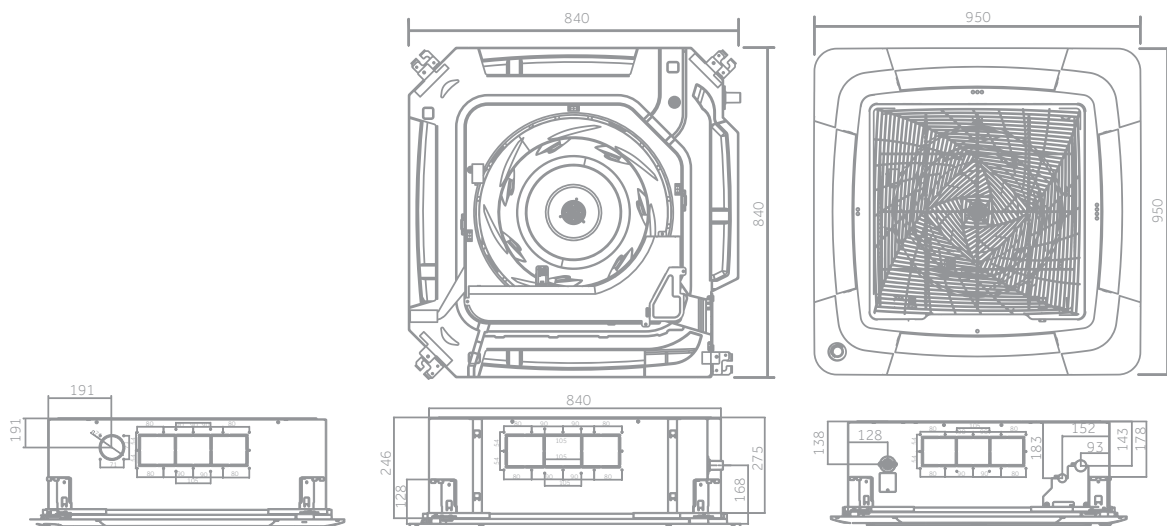

# CEILING FLOOR NEW

Haier

3,5 kW

5,0 kW

7,1 kW

OPTIONAL CONTROL

MULTISPLIT



Silence



Flow +



5 Speed Fan



Fresh Air



On-Off Card



Wi-Fi control integrated



UVC Sterilisation

- Low noise level
- Flow +: Internal deflectors are divided into two groups with independent motors (independent right-left airflow)
- 5 fan speed: turbo, high, medium, low, super low (only with YR-HQS01 or wired controller)
- 'Fresh air' knockout is incorporated in the chassis to allow fresh air introduction of up to 20% of nominal unit air flow without compromising the cooling capacity. More than 20% of the air conditioner's thermal cooling capacity is penalised.
- Wi-Fi control integrated
- UVC Sterilisation

Indoor Unit	Model		AC35S2SG1FA(H)	AC50S2SG1FA(H)	AC71S2SG1FA(H)
<b>Performance data</b>					
Output power - COOLING	nom (min-max)	kW	3,50	5,00	7,10
Output power - HEATING	nom (min-max)	kW	4,00	5,80	7,50
Power supply		Ph/V/Hz	1/220-240/50/60	1/220-240/50/60	1/220-240/50/60
Treated air volume	(H/M/L/Q)	m <sup>3</sup> /h	750/620/500/400	880/750/650/500	1250/1128/930/840
<b>Indoor Unit</b>					
High sound power		dB	53	57	61
Sound pressure		dB(A)	39/36/33/30	44/41/38/35	43/40/38/35
Net dimensions	WxDxH	mm	1000x230x680	1000x230x680	1325x230x680
Packaging dimensions	WxDxH	mm	1100x305x779	1100x305x779	1425x305x779
Net/gross weight		kg	26,0/32,0	26,0/32,0	33,5/41,9
<b>Installation data</b>					
Liquid pipe	∅	mm (inch)	6,35 (1/4)	6,35 (1/4)	9,52 (3/8)
Gas pipe	∅	mm (inch)	9,52 (3/8)	12,70 (1/2)	15,88 (5/8)

AC35 - AC50 - AC71

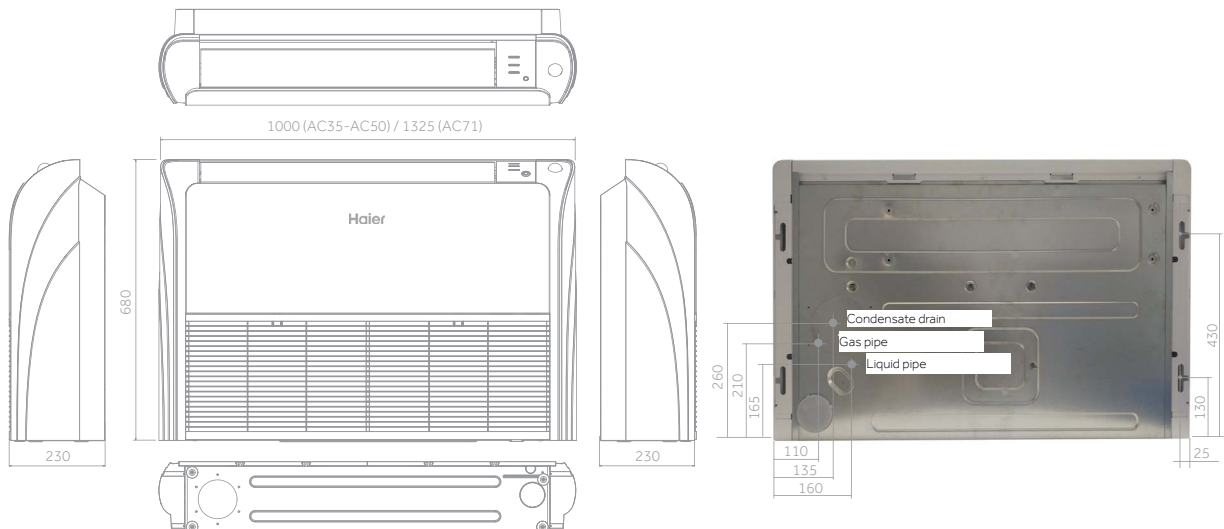

# SLIM DUCT LOW PRESSURE

2,5 kW

3,5 kW

5,0 kW

7,1 kW

OPTIONAL CONTROL

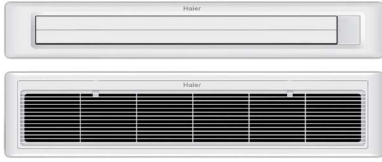

Silence

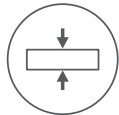

Compact Design



3D



Condensate  
Drain Pump



Flexible  
Installation



UVC Sterilisation



Wi-Fi control  
integrated

- Low noise level
- Compact design
- Panel kit (OPTIONAL): air supply and intake grill

- Condensate drain pump
- Flexible installation
- UVC Sterilisation
- Wi-Fi control integrated



Indoor Unit	Model		AD25S2SS1FA(H)	AD35S2SS1FA(H)	AD50S2SS1FA(H)	AD71S2SS1FA(H)
<b>Performance data</b>						
Output power - COOLING	nom (min-max)	kW	2,50	3,50	5,00	7,10
Output power - HEATING	nom (min-max)	kW	3,00	4,00	5,50	7,50
Power supply		Ph/V/Hz	1/220-240/50/60	1/220-240/50/60	1/220-240/50/60	1/220-240/50/60
Treated air volume	(H/M/L/Q)	m3/h	530/460/390/330	600/480/420/350	900/750/600	1000/850/750
External static pressure		Pa	0/10/20/40	0/10/20/40	0/10/20/40	0/10/20/40
<b>Indoor Unit</b>						
High sound power		dB	50	53	54	57
Sound pressure		dB(A)	29/28/25	33/28/25	36/34/32	49/46/44/42
Net dimensions	WxDxH	mm	850x420x185	850x420x185	1170x420x185	1170x420x185
Packaging dimensions	WxDxH	mm	1045x530x260	1045x530x260	1365x530x260	1365x530x260
Net/gross weight		kg	16,0/21,0	16,0/21,0	22,0/28,0	25,2/28,4
<b>Installation data</b>						
Liquid pipe	Ø	mm (inch)	6,35 (1/4)	6,35 (1/4)	6,35 (1/4)	9,52 (3/8)
Gas pipe	Ø	mm (inch)	9,52 (3/8)	9,52 (3/8)	12,70 (1/2)	15,88 (5/8)
Panel	Model		P1B-890IA/D	P1B-890IA/D	P1B-1210IA/D	P1B-1210IA/D
Panel Net dimensions			890x190x100 (outlet panel) 890x290,5x32,4 (inlet panel)		1210x190x100 (outlet panel) 1210x290,5x32,4 (inlet panel)	
Panel Packaging dimensions			938x335x220	938x335x220	1258x335x220	1258x335x220
Panel Net/gross weight			4,0/5,0	4,0/5,0	5,0/6,0	5,0/6,0

AD25 - AD35 - AD50 - AD71

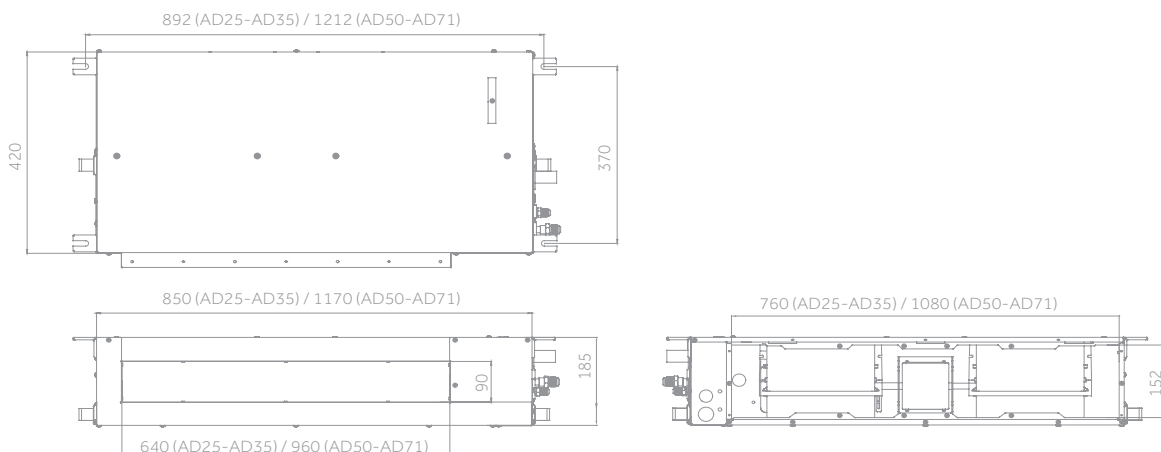

# DUCTED MEDIUM PRESSURE

Haier

3,5 kW

5,0 kW

7,1 kW

OPTIONAL CONTROL

MULTISPLIT



Silence

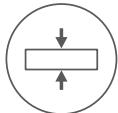

Compact Design



Fresh Air



Condensate Drain Pump



Easy Installation



UVC Sterilisation



Wi-Fi control integrated

- Low noise level
- Compact design
- Fresh Air allows changing the ambient air

- Condensate drain pump
- Easy installation

- Wi-Fi control integrated
- UVC Sterilisation

Indoor Unit	Model		AD35S2SM3FA(H)	AD50S2SM3FA(H)	AD71S2SM3FA(H)
<b>Performance data</b>					
Output power - COOLING	nom (min-max)	kW	3,50	5,00	7,10
Output power - HEATING	nom (min-max)	kW	4,00	6,00	7,50
Power supply		Ph/V/Hz	1/220-240/50/60	1/220-240/50/60	1/220-240/50/60
Treated air volume	(H/M/L/Q)	m3/h	840/720/600/450	1020/900/780/550	1440/1260/1100/900
External static pressure		Pa	25(default)/37/50/70/90/100/110/120/130/150	25(default)/37/50/70/90/100/110/120/130/150	25(default)/37/50/70/90/100/110/120/130/150
<b>Indoor Unit</b>					
High sound power		dB	55	56	58
Sound pressure		dB(A)	41/35/28/26	43/37/30/28	44/41/39/36
Net dimensions	WxDxH	mm	700x700x248	1100x700x248	1100x700x248
Packaging dimensions	WxDxH	mm	914x866x318	1316x866x318	1316x866x318
Net/gross weight		kg	26,0/30,0	31,0/35,0	31,0/35,0
<b>Installation data</b>					
Liquid pipe	Ø	mm (inch)	6,35 (1/4)	6,35 (1/4)	9,52 (3/8)
Gas pipe	Ø	mm (inch)	9,52 (3/8)	12,70 (1/2)	15,88 (5/8)

AD35 - AD50 - AD71

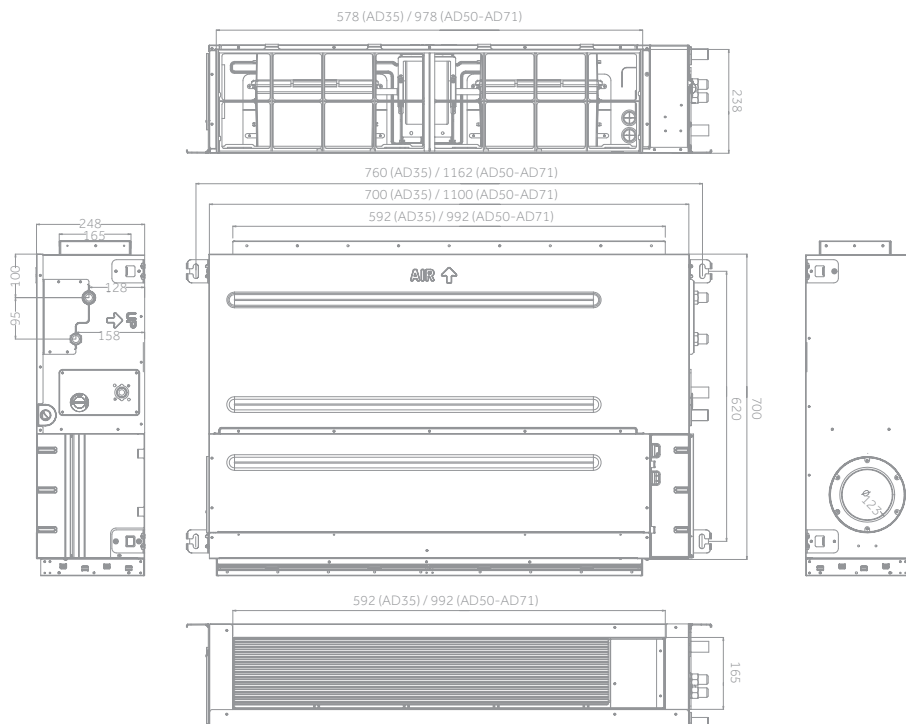

## MULTISPLIT COMPATIBILITY

N. IU	IU A	IU B	IU C	IU D	IU E	Total IU kW	MultiSplit Outdoor Units								Total Combinations	
							2U40S25M1FA	2U50S25M1FA-3	3U55S2SR5FA	3U70S2SR5FA	4U75S2SR5FA	4U85S2SR5FA	5U90S2SS5FA	5U105S2SS5FA		5U125S2SN1FA
2	20	20	0	0	0	4,0	✓●	✓●	✓	✓	✓		✓			8
	20	25	0	0	0	4,5	✓●	✓●	✓●	✓	✓		✓	✓	✓	10
	20	35	0	0	0	5,5	✓●	✓●	✓●	✓●	✓		✓	✓	✓	10
	20	42	0	0	0	6,2		✓●	✓●	✓	✓●		✓	✓	✓	8
	20	50	0	0	0	7,0			✓●	✓●	✓		✓	✓	✓	8
	20	71	0	0	0	9,1				✓●	✓●		✓	✓	✓	5
	25	25	0	0	0	5,0	✓●	✓●	✓●	✓●	✓		✓	✓	✓	10
	25	35	0	0	0	6,0	✓●	✓●	✓●	✓●	✓		✓	✓	✓	10
	25	42	0	0	0	6,7		✓●	✓●	✓	✓●		✓	✓	✓	8
	25	50	0	0	0	7,5			✓●	✓●	✓		✓	✓	✓	8
	25	71	0	0	0	9,6				✓●	✓●		✓	✓	✓	5
	35	35	0	0	0	7,0		✓●	✓●	✓●	✓●		✓	✓	✓	9
	35	42	0	0	0	7,7		✓●		✓●	✓●		✓	✓	✓	7
	35	50	0	0	0	8,5				✓●	✓●		✓	✓	✓	7
	35	71	0	0	0	10,6				✓●	✓●		✓	✓	✓	5
	42	42	0	0	0	8,4		✓●		✓●	✓●		✓	✓	✓	7
	42	50	0	0	0	9,2				✓●	✓●		✓	✓	✓	5
	42	71	0	0	0	11,3				✓●	✓●		✓	✓	✓	5
	50	50	0	0	0	10,0				✓●	✓●		✓	✓	✓	5
	50	71	0	0	0	12,1				✓●	✓●		✓	✓	✓	5
71	71	0	0	0	14,2				✓●	✓●		✓	✓	✓	3	
3	20	20	20	0	0	6,0			✓●	✓●	✓●	✓	✓	✓	✓	7
	20	20	25	0	0	6,5			✓●	✓●	✓●	✓	✓	✓	✓	7
	20	20	35	0	0	7,5			✓●	✓●	✓●	✓	✓	✓	✓	7
	20	20	42	0	0	8,2			✓●	✓●	✓●	✓	✓	✓	✓	6
	20	20	50	0	0	9,0			✓●	✓●	✓●	✓	✓	✓	✓	6
	20	20	71	0	0	11,1			✓●	✓●	✓●	✓	✓	✓	✓	5
	20	25	25	0	0	7,0			✓●	✓●	✓●	✓	✓	✓	✓	7
	20	25	35	0	0	8,0			✓●	✓●	✓●	✓	✓	✓	✓	7
	20	25	42	0	0	8,7			✓●	✓●	✓●	✓	✓	✓	✓	6
	20	25	50	0	0	9,5			✓●	✓●	✓●	✓	✓	✓	✓	6
	20	25	71	0	0	11,6			✓●	✓●	✓●	✓	✓	✓	✓	5
	20	35	35	0	0	9,0			✓●	✓●	✓●	✓	✓	✓	✓	6
	20	35	42	0	0	9,7			✓●	✓●	✓●	✓	✓	✓	✓	6
	20	35	50	0	0	10,5			✓●	✓●	✓●	✓	✓	✓	✓	5
	20	35	71	0	0	12,6			✓●	✓●	✓●	✓	✓	✓	✓	5
	20	42	42	0	0	10,4			✓●	✓●	✓●	✓	✓	✓	✓	5
	20	42	50	0	0	11,2			✓●	✓●	✓●	✓	✓	✓	✓	5
	20	42	71	0	0	13,3			✓●	✓●	✓●	✓	✓	✓	✓	5
	20	50	50	0	0	12,0			✓●	✓●	✓●	✓	✓	✓	✓	3
	20	50	71	0	0	14,1			✓●	✓●	✓●	✓	✓	✓	✓	2
	25	25	25	0	0	7,5			✓●	✓●	✓●	✓	✓	✓	✓	7
	25	25	35	0	0	8,5			✓●	✓●	✓●	✓	✓	✓	✓	7
	25	25	42	0	0	9,2			✓●	✓●	✓●	✓	✓	✓	✓	6
	25	25	50	0	0	10,0			✓●	✓●	✓●	✓	✓	✓	✓	5
	25	25	71	0	0	12,1			✓●	✓●	✓●	✓	✓	✓	✓	5
	25	35	35	0	0	9,5			✓●	✓●	✓●	✓	✓	✓	✓	6
	25	35	42	0	0	10,2			✓●	✓●	✓●	✓	✓	✓	✓	5
	25	35	50	0	0	11,0			✓●	✓●	✓●	✓	✓	✓	✓	5
	25	35	71	0	0	13,1			✓●	✓●	✓●	✓	✓	✓	✓	5
	25	42	42	0	0	10,9			✓●	✓●	✓●	✓	✓	✓	✓	5
	25	42	50	0	0	11,7			✓●	✓●	✓●	✓	✓	✓	✓	5
	25	42	71	0	0	13,8			✓●	✓●	✓●	✓	✓	✓	✓	3
	25	50	50	0	0	12,5			✓●	✓●	✓●	✓	✓	✓	✓	4
	25	50	71	0	0	14,6			✓●	✓●	✓●	✓	✓	✓	✓	2
	35	35	35	0	0	10,5			✓●	✓●	✓●	✓	✓	✓	✓	5
	35	35	42	0	0	11,2			✓●	✓●	✓●	✓	✓	✓	✓	5
	35	35	50	0	0	12,0			✓●	✓●	✓●	✓	✓	✓	✓	5
	35	35	71	0	0	14,1			✓●	✓●	✓●	✓	✓	✓	✓	3
	35	42	42	0	0	11,9			✓●	✓●	✓●	✓	✓	✓	✓	4
	35	42	50	0	0	12,7			✓●	✓●	✓●	✓	✓	✓	✓	4
35	50	50	0	0	13,5			✓●	✓●	✓●	✓	✓	✓	✓	4	
42	42	42	0	0	12,6			✓●	✓●	✓●	✓	✓	✓	✓	4	
42	42	50	0	0	13,4			✓●	✓●	✓●	✓	✓	✓	✓	4	
42	50	50	0	0	14,2			✓●	✓●	✓●	✓	✓	✓	✓	2	
50	50	50	0	0	15,0			✓●	✓●	✓●	✓	✓	✓	✓	2	
4	20	20	20	20	0	8,0			✓●	✓●	✓	✓	✓	✓	✓	5
	20	20	20	25	0	8,5			✓●	✓●	✓	✓	✓	✓	✓	5
	20	20	20	35	0	9,5			✓●	✓●	✓	✓	✓	✓	✓	5
	20	20	20	42	0	10,2			✓●	✓●	✓	✓	✓	✓	✓	5
	20	20	20	50	0	11,0			✓●	✓●	✓	✓	✓	✓	✓	5
	20	20	20	71	0	13,1			✓●	✓●	✓	✓	✓	✓	✓	5
	20	20	25	25	0	9,0			✓●	✓●	✓	✓	✓	✓	✓	5
	20	20	25	35	0	10,0			✓●	✓●	✓	✓	✓	✓	✓	5
	20	20	25	42	0	10,7			✓●	✓●	✓	✓	✓	✓	✓	5
	20	20	25	50	0	11,5			✓●	✓●	✓	✓	✓	✓	✓	5
	20	20	25	71	0	13,6			✓●	✓●	✓	✓	✓	✓	✓	5
	20	20	35	35	0	11,0			✓●	✓●	✓	✓	✓	✓	✓	5
	20	20	35	42	0	11,7			✓●	✓●	✓	✓	✓	✓	✓	5
	20	20	35	50	0	12,5			✓●	✓●	✓	✓	✓	✓	✓	5
	20	20	35	71	0	14,6			✓●	✓●	✓	✓	✓	✓	✓	2
	20	20	42	42	0	12,4			✓●	✓●	✓	✓	✓	✓	✓	5
	20	20	42	50	0	13,2			✓●	✓●	✓	✓	✓	✓	✓	5
	20	20	50	50	0	14,0			✓●	✓●	✓	✓	✓	✓	✓	3
	20	25	25	25	0	9,5			✓●	✓●	✓	✓	✓	✓	✓	5
	20	25	25	35	0	10,5			✓●	✓●	✓	✓	✓	✓	✓	5
	20	25	25	42	0	11,2			✓●	✓●	✓	✓	✓	✓	✓	5
	20	25	25	50	0	12,0			✓●	✓●	✓	✓	✓	✓	✓	5
	20	25	25	71	0	14,1			✓●	✓●	✓	✓	✓	✓	✓	2
	20	25	35	35	0	11,5			✓●	✓●	✓	✓	✓	✓	✓	5
	20	25	35	42	0	12,2			✓●	✓●	✓	✓	✓	✓	✓	5
	20	25	35	50	0	13,0			✓●	✓●	✓	✓	✓	✓	✓	5

CONT'D →

**LEGEND**

- ✓ COMBINATION ALLOWED
- ECO BONUS

**OPERATING SIMULTANEOUSLY**

OK

NOTE - THE POWER OF THE INDOOR UNITS IS HIGHER THAN THE POWER OF THE OUTDOOR UNITS

## MULTISPLIT COMPATIBILITY

N. IU	IU A	IU B	IU C	IU D	IU E	Total IU kW	MultiSplit Outdoor Units					Total Combinations				
							2U40S2SM1FA	2U50S2SM1FA-3	3U55S2SR5FA	3U70S2SR5FA	4U75S2SR5FA		4U85S2SR5FA	5U90S2SS5FA	5U105S2SS5FA	5U125S2SN1FA
4	20	25	42	42	0	12,9					✓●	✓●	✓	✓	✓	5
	20	25	42	50	0	13,7					✓●	✓●	✓	✓	✓	5
	20	25	50	50	0	14,5							✓	✓	✓	2
	20	35	35	35	0	12,5					✓●	✓●	✓	✓	✓	5
	20	35	35	42	0	13,2					✓●	✓●	✓	✓	✓	5
	20	35	35	50	0	14,0							✓	✓	✓	3
	20	35	42	42	0	13,9							✓	✓	✓	3
	20	35	42	50	0	14,7							✓	✓	✓	2
	20	42	42	42	0	14,6							✓	✓	✓	3
	25	25	25	25	0	10,0					✓●	✓●	✓	✓	✓	5
	25	25	25	35	0	11,0					✓●	✓●	✓●	✓	✓	5
	25	25	25	42	0	11,7					✓●	✓●	✓●	✓	✓	5
	25	25	25	50	0	12,5						✓●	✓●	✓	✓	4
	25	25	25	71	0	14,6							✓	✓	✓	2
	25	25	35	35	0	12,0					✓●	✓●	✓●	✓	✓	5
	25	25	35	42	0	12,7						✓●	✓●	✓	✓	4
	25	25	35	50	0	13,5						✓●	✓●	✓	✓	4
	25	25	42	42	0	13,4						✓●	✓●	✓	✓	4
	25	25	42	50	0	14,2							✓	✓	✓	2
	25	25	50	50	0	15,0							✓	✓	✓●	2
	25	35	35	35	0	13,0						✓●	✓●	✓●	✓●	4
	25	35	35	42	0	13,7						✓●	✓●	✓	✓●	4
	25	35	35	50	0	14,5							✓	✓	✓●	2
	25	35	42	42	0	14,4							✓	✓	✓●	2
	35	35	35	35	0	14,0						✓●	✓●	✓	✓●	4
	35	35	35	42	0	14,7							✓	✓	✓●	2
	5	20	20	20	20	20	10,0						✓●	✓	✓●	3
		20	20	20	20	25	10,5						✓●	✓	✓●	3
		20	20	20	20	35	11,5						✓●	✓	✓●	3
		20	20	20	20	42	12,2						✓●	✓	✓●	3
		20	20	20	20	50	13,0						✓●	✓	✓●	3
		20	20	20	20	71	15,1							✓	✓	✓●
20		20	20	25	25	11,0						✓●	✓	✓●	3	
20		20	20	25	35	12,0						✓●	✓	✓●	3	
20		20	20	25	42	12,7						✓●	✓	✓●	3	
20		20	20	25	50	13,5						✓●	✓	✓●	3	
20		20	20	25	71	15,6							✓	✓	✓●	1
20		20	20	35	35	13,0						✓●	✓	✓●	3	
20		20	20	35	42	13,7						✓●	✓	✓●	3	
20		20	20	35	50	14,5							✓	✓	✓●	2
20		20	20	35	71	16,6							✓	✓	✓●	1
20		20	20	42	42	14,4							✓	✓	✓●	2
20		20	20	42	50	15,2							✓	✓	✓●	1
20		20	20	42	71	17,3							✓	✓	✓●	1
20		20	25	25	25	11,5						✓●	✓	✓●	3	
20		20	25	25	35	12,5						✓●	✓	✓●	3	
20		20	25	25	42	13,2						✓●	✓	✓●	3	
20		20	25	25	50	14,0						✓●	✓	✓●	3	
20		20	25	25	71	16,1							✓	✓	✓●	1
20		20	25	35	35	13,5						✓●	✓	✓●	3	
20		20	25	35	42	14,2							✓	✓	✓●	2
20		20	25	35	50	15,0							✓	✓	✓●	2
20		20	25	35	71	17,1							✓	✓	✓●	1
20		20	25	42	42	14,9							✓	✓	✓●	2
20		20	25	42	50	15,7							✓	✓	✓●	1
20		20	25	42	71	17,8							✓	✓	✓●	1
20		20	35	35	35	14,5							✓	✓	✓●	2
20		20	35	35	42	15,2							✓	✓	✓●	1
20		20	35	35	50	16,0							✓	✓	✓●	1
20		20	35	35	71	18,1							✓	✓	✓●	1
20		25	25	25	25	12,0						✓●	✓	✓●	3	
20		25	25	25	35	13,0						✓●	✓	✓●	3	
20		25	25	25	42	13,7						✓●	✓	✓●	3	
20		25	25	25	50	14,5							✓	✓	✓●	2
20		25	25	25	71	16,6							✓	✓	✓●	1
20		25	25	35	35	14,0							✓	✓	✓●	2
20		25	25	35	42	14,7							✓	✓	✓●	2
20		25	25	35	50	15,5							✓	✓	✓●	1
20		25	25	35	71	17,6							✓	✓	✓●	1
20		25	35	35	35	15,0							✓	✓	✓●	2
20		25	35	35	42	15,7							✓	✓	✓●	1
20		25	35	35	50	16,5							✓	✓	✓●	1
20		25	35	35	71	18,6							✓	✓	✓●	1
25		25	25	25	25	12,5						✓●	✓	✓●	3	
25		25	25	25	35	13,5						✓●	✓	✓●	3	
25		25	25	25	42	14,2							✓	✓	✓●	2
25		25	25	25	50	15,0							✓	✓	✓●	2
25		25	25	25	71	17,1							✓	✓	✓●	2
25	25	25	35	35	14,5							✓	✓	✓●	2	
25	25	25	35	42	17,7							✓	✓	✓●	1	
25	25	25	35	50	18,5							✓	✓	✓●	1	
25	25	25	35	71	20,6							✓	✓	✓●	1	
25	25	25	42	42	18,4							✓	✓	✓●	1	
25	25	25	42	50	19,2							✓	✓	✓●	1	
25	25	25	50	50	20,0							✓	✓	✓●	1	
25	25	35	35	35	18,0							✓	✓	✓●	1	
25	25	35	35	42	18,7							✓	✓	✓●	1	
25	25	35	35	50	19,5							✓	✓	✓●	1	
25	25	42	42	42	20,1							✓	✓	✓●	1	
25	25	42	42	50	20,9							✓	✓	✓●	1	
25	35	35	35	35	19,0							✓	✓	✓●	1	
25	35	35	35	42	19,7							✓	✓	✓●	1	
25	35	35	35	50	20,5							✓	✓	✓●	1	
35	35	35	35	35	21,0							✓	✓	✓●	1	
35	35	35	35	35	21,7							✓	✓	✓●	1	

**LEGEND**

- ✓ COMBINATION ALLOWED
- ECO BONUS

**OPERATING SIMULTANEOUSLY**

- OK

NOTE - THE POWER OF THE INDOOR UNITS IS HIGHER THAN THE POWER OF THE OUTDOOR UNITS

The data in this catalogue is purely indicative as the data may vary. Please be advised to check the accuracy of the data with the supplier before purchasing products.



**2U40S2SM1FA Inverter** (Values in the table refer to FLEXIS PLUS series)

COOLING																
Combinations			Output power (kW)		System output power (kW)			Absorbed power (kW)			Absorbed current (A)			EER	SEER	Energy class
IU	A	B	A	B	Min	Nom	Max	Min	Nom	Max	Min	Nom	Max			
2	2,00	2,00	1,90	1,90	1,10	3,80	4,60	0,29	0,94	1,60	1,20	4,30	7,20	4,04	6,20	A++
	2,00	2,50	1,75	2,05	1,10	3,80	4,60	0,30	0,94	1,61	1,30	4,30	7,30	4,04	6,20	A++
	2,00	3,50	1,55	2,35	1,10	3,90	4,70	0,30	0,97	1,63	1,30	4,50	7,40	4,03	6,20	A++
	2,50	2,50	2,00	2,00	1,10	4,00	4,70	0,30	0,99	1,63	1,30	4,50	7,40	4,04	6,20	A++
	2,50	3,50	1,90	2,10	1,10	4,00	4,80	0,30	0,99	1,65	1,30	4,50	7,50	4,04	6,20	A++

HEATING																
Combinations			Output power (kW)		System output power (kW)			Absorbed power (kW)			Absorbed current (A)			COP	SCOP	Energy class
IU	A	B	A	B	Min	Nom	Max	Min	Nom	Max	Min	Nom	Max			
2	2,00	2,00	2,10	2,10	1,80	4,20	4,80	0,38	1,03	2,20	1,70	4,90	9,80	4,09	4,00	A+
	2,00	2,50	1,90	2,30	1,80	4,20	4,90	0,38	1,03	2,22	1,70	4,90	9,90	4,09	4,00	A+
	2,00	3,50	1,80	2,60	1,80	4,40	5,00	0,38	1,08	2,22	1,70	5,10	9,90	4,08	4,00	A+
	2,50	2,50	2,20	2,20	1,80	4,40	5,00	0,38	1,08	2,23	1,70	5,20	10,00	4,09	4,00	A+
	2,50	3,50	2,00	2,40	1,80	4,40	5,20	0,38	1,07	2,25	1,70	5,30	10,10	4,10	4,00	A+

**2U40S2SM1FA Inverter** (Values in the table refer to PEARL series)

COOLING																
Combinations			Output power (kW)		System output power (kW)			Absorbed power (kW)			Absorbed current (A)			EER	SEER	Energy class
UI	A	B	A	B	min	nom	max	min	nom	max	min	nom	max			
2	2,00	2,00	1,90	1,90	1,00	3,80	4,30	0,29	0,94	1,60	1,30	4,30	7,20	4,04	6,20	A++
	2,00	2,50	1,75	2,05	1,00	3,80	4,40	0,30	0,94	1,61	1,40	4,30	7,30	4,04	6,20	A++
	2,00	3,50	1,55	2,35	1,00	3,90	4,40	0,30	0,97	1,63	1,40	4,50	7,40	4,03	6,20	A++
	2,50	2,50	2,00	2,00	1,00	4,00	4,50	0,30	0,99	1,63	1,40	4,50	7,40	4,04	6,20	A++
	2,50	3,50	1,90	2,10	1,00	4,00	4,50	0,30	0,99	1,65	1,40	4,50	7,50	4,04	6,20	A++

HEATING																
Combinations			Output power (kW)		System output power (kW)			Absorbed power (kW)			Absorbed current (A)			COP	SCOP	Energy class
UI	A	B	A	B	min	nom	max	min	nom	max	min	nom	max			
2	2,00	2,00	2,10	2,10	1,50	4,20	4,60	0,38	1,03	2,20	1,70	4,90	9,80	4,09	4,00	A+
	2,00	2,50	1,90	2,30	1,50	4,20	4,70	0,38	1,03	2,22	1,70	4,90	9,90	4,09	4,00	A+
	2,00	3,50	1,80	2,60	1,50	4,40	4,70	0,38	1,08	2,22	1,70	5,10	9,90	4,08	4,00	A+
	2,50	2,50	2,20	2,20	1,50	4,40	4,80	0,38	1,08	2,23	1,70	5,20	10,00	4,09	4,00	A+
	2,50	3,50	2,00	2,40	1,50	4,40	4,80	0,38	1,07	2,25	1,70	5,30	10,10	4,10	4,00	A+

## COMBINATIONS TABLE

2U50S2SM1FA-3 Inverter (Values in the table refer to FLEXIS PLUS series)

COOLING																
Combinations			Output power (kW)		System output power (kW)			Absorbed power (kW)			Absorbed current (A)			EER	SEER	Energy class
IU	A	B	A	B	Min	Nom	Max	Min	Nom	Max	Min	Nom	Max			
2	2,00	2,00	2,45	2,45	1,30	4,90	5,60	0,33	1,35	2,36	1,56	6,00	10,58	3,63	6,50	A++
	2,00	2,50	2,20	2,70	1,30	4,90	5,60	0,33	1,36	2,37	1,56	6,10	10,62	3,60	6,50	A++
	2,00	3,50	2,00	3,00	1,30	5,00	5,80	0,35	1,43	2,51	1,65	6,30	11,25	3,50	6,50	A++
	2,00	4,20	1,90	3,10	1,30	5,00	5,80	0,35	1,43	2,51	1,65	6,30	11,25	3,50	6,50	A++
	2,00	5,00	1,80	3,20	1,30	5,00	5,80	0,35	1,43	2,51	1,65	6,30	11,25	3,50	6,50	A++
	2,50	2,50	2,50	2,50	1,30	5,00	5,80	0,35	1,43	2,51	1,64	6,30	11,25	3,50	6,50	A++
	2,50	3,50	2,20	2,80	1,30	5,00	5,80	0,35	1,39	2,52	1,64	6,20	11,30	3,60	6,50	A++
	2,50	4,20	2,10	2,90	1,30	5,00	6,00	0,35	1,43	2,55	1,64	6,30	11,43	3,50	6,50	A++
	2,50	5,00	2,00	3,00	1,30	5,00	6,00	0,35	1,43	2,55	1,64	6,30	11,43	3,50	6,50	A++
	3,50	3,50	2,50	2,50	1,30	5,00	6,00	0,35	1,43	2,55	1,64	6,30	11,50	3,50	6,50	A++
	3,50	4,20	2,40	2,70	1,30	5,10	6,10	0,35	1,46	2,57	1,64	6,50	11,52	3,50	6,50	A++
	3,50	5,00	2,40	2,80	1,30	5,20	6,20	0,35	1,49	2,60	1,64	6,70	11,65	3,50	6,50	A++
4,20	4,20	2,60	2,60	1,30	5,20	6,20	0,35	1,49	2,60	1,64	6,70	11,65	3,50	6,50	A++	

HEATING																
Combinations			Output power (kW)		System output power (kW)			Absorbed power (kW)			Absorbed current (A)			COP	SCOP	Energy class
IU	A	B	A	B	Min	Nom	Max	Min	Nom	Max	Min	Nom	Max			
2	2,00	2,00	2,50	2,50	1,50	5,00	6,30	0,49	1,35	2,71	2,20	6,70	12,15	3,71	4,00	A+
	2,00	2,50	2,40	2,60	1,50	5,00	6,30	0,49	1,35	2,72	2,20	6,80	12,19	3,71	4,00	A+
	2,00	3,50	2,50	2,70	1,60	5,20	6,40	0,52	1,40	2,73	2,30	7,00	12,24	3,71	4,00	A+
	2,00	4,20	2,40	2,80	1,60	5,20	6,50	0,52	1,40	2,76	2,30	6,90	12,37	3,71	4,00	A+
	2,00	5,00	2,30	2,90	1,60	5,20	6,50	0,52	1,40	2,76	2,30	6,90	12,37	3,71	4,00	A+
	2,50	2,50	2,60	2,60	1,60	5,20	6,50	0,52	1,40	2,76	2,30	6,90	12,37	3,71	4,00	A+
	2,50	3,50	2,50	2,70	1,70	5,20	6,60	0,53	1,40	2,77	2,40	6,90	12,42	3,71	4,00	A+
	2,50	4,20	2,40	2,80	1,80	5,20	6,60	0,55	1,40	2,80	2,50	6,80	12,50	3,71	4,00	A+
	2,50	5,00	2,20	3,00	1,80	5,20	6,60	0,55	1,40	2,80	2,50	6,80	12,50	3,71	4,00	A+
	3,50	3,50	2,60	2,60	1,80	5,20	6,60	0,55	1,40	2,80	2,50	6,80	12,55	3,71	4,00	A+
	3,50	4,20	2,50	2,80	1,80	5,30	6,70	0,55	1,43	2,82	2,50	6,80	12,64	3,71	4,00	A+
	3,50	5,00	2,40	3,00	1,80	5,40	6,80	0,55	1,46	2,85	2,50	6,80	12,77	3,71	4,00	A+
4,20	4,20	2,70	2,70	1,80	5,40	6,80	0,55	1,46	2,85	2,50	6,80	12,77	3,71	4,00	A+	

2U50S2SM1FA-3 Inverter (Values in the table refer to PEARL series)

COOLING																
Combinations			Output power (kW)		System output power (kW)			Absorbed power (kW)			Absorbed current (A)			EER	SEER	Energy class
UI	A	B	A	B	min	nom	max	min	nom	max	min	nom	max			
2	2,00	2,00	2,35	2,35	1,10	4,70	5,10	0,33	1,34	2,08	1,56	6,08	9,32	3,50	6,10	A++
	2,00	2,50	2,10	2,60	1,10	4,70	5,10	0,33	1,34	2,08	1,56	6,08	9,32	3,50	6,10	A++
	2,00	3,50	1,90	2,90	1,10	4,80	5,20	0,35	1,39	2,10	1,65	6,30	9,41	3,45	6,10	A++
	2,00	5,00	1,70	3,10	1,10	4,80	5,20	0,35	1,39	2,10	1,65	6,30	9,41	3,45	6,10	A++
	2,50	2,50	2,40	2,40	1,10	4,80	5,20	0,35	1,39	2,10	1,64	6,30	9,41	3,45	6,10	A++
	2,50	3,50	2,10	2,70	1,10	4,80	5,20	0,35	1,39	2,10	1,64	6,30	9,41	3,45	6,10	A++
	2,50	5,00	1,90	2,90	1,10	4,80	5,40	0,35	1,39	2,10	1,64	6,30	9,41	3,45	6,10	A++
	3,50	3,50	2,40	2,40	1,10	4,80	5,40	0,35	1,39	2,10	1,64	6,30	9,41	3,45	6,10	A++
	3,50	5,00	2,30	2,70	1,10	5,00	5,50	0,35	1,45	2,30	1,64	6,56	10,31	3,45	6,10	A++

HEATING																
Combinations			Output power (kW)		System output power (kW)			Absorbed power (kW)			Absorbed current (A)			COP	SCOP	Energy class
UI	A	B	A	B	min	nom	max	min	nom	max	min	nom	max			
2	2,00	2,00	2,40	2,40	1,30	4,80	5,70	0,49	1,29	2,35	2,20	5,80	10,53	3,71	4,00	A+
	2,00	2,50	2,30	2,50	1,30	4,80	5,70	0,49	1,29	2,35	2,20	5,80	10,53	3,71	4,00	A+
	2,00	3,50	2,40	2,60	1,40	5,00	5,80	0,52	1,35	2,35	2,30	6,04	10,53	3,71	4,00	A+
	2,00	5,00	2,20	2,80	1,40	5,00	5,80	0,52	1,35	2,37	2,30	6,04	10,62	3,71	4,00	A+
	2,50	2,50	2,50	2,50	1,40	5,00	5,80	0,52	1,35	2,37	2,30	6,04	10,62	3,71	4,00	A+
	2,50	3,50	2,40	2,60	1,50	5,00	5,90	0,53	1,35	2,37	2,40	6,04	10,62	3,71	4,00	A+
	2,50	5,00	2,10	2,90	1,60	5,00	5,90	0,55	1,35	2,40	2,50	6,04	12,50	3,71	4,00	A+
	3,50	3,50	2,50	2,50	1,60	5,00	5,90	0,55	1,35	2,40	2,50	6,04	10,76	3,71	4,00	A+
	3,50	5,00	2,30	2,90	1,70	5,20	6,00	0,55	1,40	2,50	2,50	6,28	11,21	3,71	4,00	A+

The data in this catalogue is purely indicative as the data may vary. Please be advised to check the accuracy of the data with the supplier before purchasing products.

### 3U55S2SR5FA Inverter (Values in the table refer to FLEXIS PLUS)

COOLING																		
Combinations				Output power (kW)			System output power (kW)			Absorbed power (kW)			Absorbed current (A)			EER	SEER	Energy class
UI	A	B	C	A	B	C	min	nom	max	min	nom	max	min	nom	max			
2	2,00	2,00	—	2,00	2,00	—	1,60	4,00	5,60	0,55	1,18	2,50	2,44	5,38	10,80	3,39	6,80	A++
	2,00	2,50	—	2,00	2,60	—	1,80	4,60	6,60	0,55	1,28	2,50	2,44	5,84	10,80	3,59	6,80	A++
	2,00	3,50	—	1,79	3,21	—	2,10	5,00	6,60	0,55	1,36	2,50	2,44	6,20	10,80	3,68	7,00	A++
	2,00	4,20	—	1,56	3,44	—	2,10	5,00	6,60	0,55	1,36	2,50	2,44	6,20	10,80	3,68	7,00	A++
	2,00	5,00	—	1,39	3,61	—	2,10	5,00	6,60	0,55	1,36	2,50	2,44	6,20	10,80	3,68	7,00	A++
	2,50	2,50	—	2,50	2,50	—	2,00	5,00	6,60	0,55	1,36	2,50	2,44	6,20	10,80	3,68	7,00	A++
	2,50	3,50	—	2,10	2,90	—	2,10	5,00	6,60	0,55	1,34	2,50	2,44	6,11	10,80	3,73	7,00	A++
	2,50	4,20	—	1,86	3,14	—	2,10	5,00	6,60	0,55	1,34	2,50	2,44	6,11	10,80	3,73	7,40	A++
	2,50	5,00	—	1,67	3,33	—	2,10	5,00	6,60	0,55	1,34	2,50	2,44	6,11	10,80	3,73	7,80	A++
3	3,50	3,50	—	2,50	2,50	—	2,10	5,00	6,60	0,55	1,34	2,50	2,44	6,11	10,80	3,73	7,80	A++
	2,00	2,00	2,00	1,67	1,67	1,67	2,10	5,00	6,60	0,55	1,29	2,50	2,44	5,89	10,80	3,88	7,60	A++
	2,00	2,00	2,50	1,52	1,52	1,97	2,10	5,00	6,60	0,55	1,29	2,50	2,44	5,89	10,80	3,88	8,00	A++
	2,00	2,00	3,50	1,32	1,32	2,37	2,10	5,00	6,60	0,55	1,27	2,50	2,44	5,79	10,80	3,94	8,00	A++
	2,00	2,50	2,50	1,39	1,81	1,81	2,10	5,00	6,60	0,55	1,27	2,50	2,44	5,79	10,80	3,94	8,30	A++
	2,00	2,50	3,50	1,22	1,59	2,20	2,10	5,00	6,60	0,55	1,27	2,50	2,44	5,79	10,80	3,94	8,30	A++
	2,50	2,50	2,50	1,67	1,67	1,67	2,10	5,00	6,60	0,55	1,25	2,50	2,44	5,70	10,80	4,00	8,50	A+++
2,50	2,50	3,50	1,48	1,48	2,05	2,10	5,00	6,60	0,55	1,25	2,50	2,44	5,70	10,80	4,00	8,50	A+++	

HEATING																		
Combinations				Output power (kW)			System output power (kW)			Absorbed power (kW)			Absorbed current (A)			COP	SCOP	Energy class
UI	A	B	C	A	B	C	min	nom	max	min	nom	max	min	nom	max			
2	2,00	2,00	—	2,30	2,30	—	1,20	4,60	7,20	0,55	1,25	2,10	2,44	5,47	9,07	3,68	3,90	A
	2,00	2,50	—	2,30	3,60	—	1,20	5,90	7,20	0,55	1,54	2,10	2,44	6,74	9,07	3,83	3,95	A
	2,00	3,50	—	2,16	4,24	—	1,20	6,40	7,20	0,55	1,72	2,10	2,44	7,52	9,07	3,72	3,95	A
	2,00	4,20	—	1,91	4,49	—	1,70	6,40	7,20	0,55	1,70	2,10	2,44	7,44	9,07	3,76	3,95	A
	2,00	5,00	—	1,77	4,63	—	1,70	6,40	7,20	0,55	1,70	2,10	2,44	7,44	9,07	3,76	3,95	A
	2,50	2,50	—	3,20	3,20	—	1,70	6,40	7,20	0,55	1,68	2,20	2,44	7,35	9,50	3,81	4,00	A+
	2,50	3,50	—	2,84	3,56	—	1,70	6,40	7,20	0,55	1,68	2,20	2,44	7,35	9,50	3,81	4,00	A+
	2,50	4,20	—	2,56	3,84	—	1,70	6,40	7,20	0,55	1,66	2,20	2,44	7,26	9,50	3,86	4,10	A+
	2,50	5,00	—	2,40	4,00	—	1,70	6,40	7,20	0,55	1,66	2,20	2,44	7,26	9,50	3,86	4,20	A+
3	3,50	3,50	—	3,20	3,20	—	1,70	6,40	7,20	0,55	1,66	2,20	2,44	7,26	9,50	3,86	4,20	A+
	2,00	2,00	2,00	2,13	2,13	2,13	1,70	6,40	7,20	0,55	1,64	2,20	2,44	7,17	9,50	3,90	4,30	A+
	2,00	2,00	2,50	1,80	1,80	2,81	1,70	6,40	7,20	0,55	1,63	2,20	2,44	7,13	9,50	3,93	4,40	A+
	2,00	2,00	3,50	1,62	1,62	3,16	1,70	6,40	7,20	0,55	1,63	2,20	2,44	7,13	9,50	3,93	4,40	A+
	2,00	2,50	2,50	1,55	2,43	2,43	1,70	6,40	7,20	0,55	1,62	2,20	2,44	7,09	9,50	3,95	4,50	A+
	2,00	2,50	3,50	1,42	2,22	2,77	1,70	6,40	7,20	0,55	1,62	2,20	2,44	7,09	9,50	3,95	4,50	A+
	2,50	2,50	2,50	2,13	2,13	2,13	1,70	6,40	7,20	0,55	1,60	2,20	2,44	7,00	9,50	4,00	4,60	A++
2,50	2,50	3,50	1,97	1,97	2,46	1,70	6,40	7,20	0,55	1,60	2,20	2,44	7,00	9,50	4,00	4,60	A++	

## COMBINATIONS TABLE

3U70S2SR5FA Inverter (Values in the table refer to FLEXIS PLUS)

COOLING																		
Combinations				Output power (kW)			System output power (kW)			Absorbed power (kW)			Absorbed current (A)			EER	SEER	Energy class
UI	A	B	C	A	B	C	min	nom	max	min	nom	max	min	nom	max			
2	2,00	2,00	—	2,00	2,00	—	1,80	4,00	5,60	0,55	1,21	2,60	2,44	5,37	11,50	3,31	6,80	A++
	2,00	2,50	—	2,00	2,60	—	1,80	4,60	6,70	0,55	1,35	2,60	2,44	5,99	11,50	3,41	6,80	A++
	2,00	3,50	—	2,00	3,60	—	1,80	5,60	7,50	0,55	1,65	2,60	2,44	7,32	11,50	3,39	6,90	A++
	2,00	4,20	—	2,00	4,40	—	1,80	6,40	7,60	0,55	1,89	2,60	2,44	8,39	11,50	3,39	6,90	A++
	2,00	5,00	—	1,94	5,06	—	2,40	7,00	7,60	0,55	2,02	2,60	2,44	8,96	11,50	3,47	6,90	A++
	2,50	2,50	—	2,60	2,60	—	2,00	5,20	7,40	0,55	1,52	2,60	2,44	6,74	11,50	3,42	6,90	A++
	2,50	3,50	—	2,60	3,60	—	2,00	6,20	7,60	0,55	1,79	2,60	2,44	7,94	11,50	3,46	6,90	A++
	2,50	4,20	—	2,60	4,40	—	2,40	7,00	7,60	0,55	2,02	2,60	2,44	8,96	11,50	3,47	7,00	A++
	2,50	5,00	—	2,33	4,67	—	2,40	7,00	7,60	0,55	2,00	2,60	2,44	8,87	11,50	3,50	7,00	A++
	3,50	3,50	—	3,40	3,40	—	2,40	6,80	7,60	0,55	2,00	2,60	2,44	8,87	11,50	3,40	7,00	A++
	3,50	4,20	—	3,15	3,85	—	2,40	7,00	7,60	0,55	1,82	2,60	2,44	8,07	11,50	3,85	7,20	A++
	3,50	5,00	—	2,86	4,14	—	2,40	7,00	7,60	0,55	1,82	2,60	2,44	8,07	11,50	3,85	7,40	A++
4,20	4,20	—	3,50	3,50	—	2,40	7,00	7,60	0,55	1,82	2,60	2,44	8,07	11,50	3,85	7,40	A++	
3	2,00	2,00	2,00	2,00	2,00	2,00	2,40	6,00	7,60	0,55	1,75	2,60	2,44	7,76	11,50	3,43	7,60	A++
	2,00	2,00	2,50	2,00	2,00	2,60	2,40	6,60	7,60	0,55	1,75	2,60	2,44	7,76	11,50	3,77	7,80	A++
	2,00	2,00	3,50	1,84	1,84	3,32	2,40	7,00	7,60	0,55	1,80	2,60	2,44	7,99	11,50	3,89	7,80	A++
	2,00	2,00	4,20	1,67	1,67	3,67	2,40	7,00	7,60	0,55	1,80	2,60	2,44	7,99	11,50	3,89	8,00	A++
	2,00	2,00	5,00	1,52	1,52	3,96	2,40	7,00	7,60	0,55	1,80	2,60	2,44	7,99	11,50	3,89	8,00	A++
	2,00	2,50	2,50	1,94	2,53	2,53	2,40	7,00	7,60	0,55	1,80	2,60	2,44	7,99	11,50	3,89	8,20	A++
	2,00	2,50	3,50	1,71	2,22	3,07	2,40	7,00	7,60	0,55	1,80	2,60	2,44	7,99	11,50	3,89	8,20	A++
	2,00	2,50	4,20	1,56	2,02	3,42	2,40	7,00	7,60	0,55	1,80	2,60	2,44	7,99	11,50	3,89	8,30	A++
	2,00	2,50	5,00	1,43	1,86	3,71	2,40	7,00	7,60	0,55	1,82	2,60	2,44	8,07	11,50	3,85	8,30	A++
	2,00	3,50	3,50	1,52	2,74	2,74	2,40	7,00	7,60	0,55	1,82	2,60	2,44	8,07	11,50	3,85	8,40	A++
	2,00	3,50	4,20	1,40	2,52	3,08	2,40	7,00	7,60	0,55	1,80	2,60	2,44	7,99	11,50	3,89	8,40	A++
	2,50	2,50	2,50	2,33	2,33	2,33	2,40	7,00	7,60	0,55	1,75	2,60	2,44	7,80	11,50	4,00	8,50	A+++
	2,50	2,50	3,50	2,07	2,07	2,86	2,40	7,00	7,60	0,55	1,75	2,60	2,44	7,80	11,50	4,00	8,50	A+++
	2,50	2,50	4,20	1,90	1,90	3,21	2,40	7,00	7,60	0,55	1,75	2,60	2,44	7,80	11,50	4,00	8,50	A+++
	2,50	3,50	3,50	1,86	2,57	2,57	2,40	7,00	7,60	0,55	1,75	2,60	2,44	7,80	11,50	4,00	8,50	A+++

HEATING																		
Combinations				Output power (kW)			System output power (kW)			Absorbed power (kW)			Absorbed current (A)			COP	SCOP	Energy class
UI	A	B	C	A	B	C	min	nom	max	min	nom	max	min	nom	max			
2	2,00	2,00	—	2,30	2,30	—	2,60	4,60	8,00	0,55	1,25	2,00	2,44	5,53	8,43	3,68	3,80	A
	2,00	2,50	—	2,30	3,60	—	2,70	5,90	8,50	0,55	1,60	2,00	2,44	7,08	8,43	3,69	3,80	A
	2,00	3,50	—	2,30	4,50	—	2,70	6,80	8,50	0,55	1,82	2,10	2,44	8,05	8,86	3,74	3,80	A
	2,00	4,20	—	2,27	5,33	—	2,90	7,60	8,50	0,55	2,00	2,10	2,44	8,85	8,86	3,80	3,90	A
	2,00	5,00	—	2,11	5,49	—	2,90	7,60	8,50	0,55	2,00	2,10	2,44	8,85	8,86	3,80	3,90	A
	2,50	2,50	—	3,60	3,60	—	2,90	7,20	8,50	0,55	2,00	2,10	2,44	8,85	8,86	3,60	3,90	A
	2,50	3,50	—	3,38	4,22	—	2,90	7,60	8,50	0,55	2,00	2,10	2,44	8,85	8,86	3,80	3,90	A
	2,50	4,20	—	3,04	4,56	—	2,90	7,60	8,50	0,55	2,00	2,10	2,44	8,85	8,86	3,80	3,95	A
	2,50	5,00	—	2,85	4,75	—	2,90	7,60	8,50	0,55	2,00	2,10	2,44	8,85	8,86	3,80	3,95	A
	3,50	3,50	—	3,75	3,75	—	2,90	7,50	8,50	0,55	2,00	2,20	2,44	8,85	9,28	3,75	4,00	A+
	3,50	4,20	—	3,45	4,15	—	2,90	7,60	8,50	0,55	2,02	2,20	2,44	8,93	9,28	3,76	4,00	A+
	3,50	5,00	—	3,26	4,34	—	2,90	7,60	8,50	0,55	2,00	2,20	2,44	8,85	9,28	3,80	4,10	A+
4,20	4,20	—	3,80	3,80	—	2,90	7,60	8,50	0,55	2,00	2,20	2,44	8,85	9,28	3,80	4,10	A+	
3	2,00	2,00	2,00	2,30	2,30	2,30	2,90	6,90	8,50	0,55	1,85	2,30	2,44	8,18	9,70	3,73	4,20	A+
	2,00	2,00	2,50	2,13	2,13	3,34	2,90	7,60	8,50	0,55	1,98	2,30	2,44	8,76	9,70	3,84	4,20	A+
	2,00	2,00	3,50	1,92	1,92	3,76	2,90	7,60	8,50	0,55	1,96	2,30	2,44	8,67	9,70	3,88	4,20	A+
	2,00	2,00	4,20	1,75	1,75	4,10	2,90	7,60	8,50	0,55	1,95	2,30	2,44	8,62	9,70	3,90	4,30	A+
	2,00	2,00	5,00	1,65	1,65	4,30	2,90	7,60	8,50	0,55	1,95	2,30	2,44	8,62	9,70	3,90	4,30	A+
	2,00	2,50	2,50	1,84	2,88	2,88	2,90	7,60	8,50	0,55	1,93	2,30	2,44	8,54	9,70	3,94	4,30	A+
	2,00	2,50	3,50	1,68	2,63	3,29	2,90	7,60	8,50	0,55	1,95	2,30	2,44	8,62	9,70	3,90	4,40	A+
	2,00	2,50	4,20	1,55	2,42	3,63	2,90	7,60	8,50	0,55	1,93	2,30	2,44	8,54	9,70	3,94	4,40	A+
	2,00	2,50	5,00	1,47	2,30	3,83	2,90	7,60	8,50	0,55	1,94	2,30	2,44	8,58	9,70	3,92	4,40	A+
	2,00	3,50	3,50	1,55	3,03	3,03	2,90	7,60	8,50	0,55	1,93	2,30	2,44	8,54	9,70	3,94	4,50	A+
	2,00	3,50	4,20	1,43	2,80	3,36	2,90	7,60	8,50	0,55	1,92	2,30	2,44	8,49	9,70	3,96	4,50	A+
	2,50	2,50	2,50	2,53	2,53	2,53	2,90	7,60	8,50	0,55	1,90	2,30	2,44	8,40	9,70	4,00	4,60	A++
	2,50	2,50	3,50	2,34	2,34	2,92	2,90	7,60	8,50	0,55	1,90	2,30	2,44	8,40	9,70	4,00	4,60	A++
	2,50	2,50	4,20	2,17	2,17	3,26	2,90	7,60	8,50	0,55	1,90	2,30	2,44	8,40	9,70	4,00	4,60	A++
	2,50	3,50	3,50	2,17	2,71	2,71	2,90	7,60	8,50	0,55	1,90	2,30	2,44	8,40	9,70	4,00	4,60	A++

The data in this catalogue is purely indicative as the data may vary. Please be advised to check the accuracy of the data with the supplier before purchasing products.

## 4U75S2SR5FA Inverter (The values in the table refer to the FLEXIS series)

COOLING																					
Combinations				Output power (kW)				System output power (kW)				Absorbed power (kW)			Absorbed current (A)			EER	SEER	Energy class	
UI	A	B	C	A	B	C	min	nom	max	min	nom	max	min	nom	max	min	nom				
2	2,00	2,00	—	—	2,00	2,00	—	—	2,00	4,00	5,60	0,55	1,30	3,00	2,44	5,77	13,31	3,08	6,20	A++	
	2,00	2,50	—	—	2,00	2,60	—	—	2,00	4,60	6,70	0,55	1,50	3,00	2,44	6,65	13,31	3,07	6,20	A++	
	2,00	3,50	—	—	2,00	3,60	—	—	2,00	5,60	8,10	0,55	1,80	3,00	2,44	7,99	13,31	3,11	6,20	A++	
	2,00	4,20	—	—	2,00	4,40	—	—	2,00	6,40	7,80	0,55	1,95	3,00	2,44	8,65	13,31	3,28	6,20	A++	
	2,00	5,00	—	—	2,00	5,20	—	—	2,00	7,20	8,70	0,55	2,20	3,00	2,44	9,76	13,31	3,27	6,20	A++	
	2,00	7,10	—	—	1,76	5,74	—	—	2,00	7,50	8,70	0,55	2,24	3,10	2,44	9,94	13,75	3,35	6,20	A++	
	2,50	2,50	—	—	2,60	2,60	—	—	2,00	5,20	7,80	0,55	1,70	3,10	2,44	7,54	13,75	3,06	6,20	A++	
	2,50	3,50	—	—	2,60	3,60	—	—	2,00	6,20	8,70	0,55	2,00	3,10	2,44	8,87	13,75	3,10	6,20	A++	
	2,50	4,20	—	—	2,60	4,40	—	—	2,00	7,00	8,70	0,55	2,10	3,10	2,44	9,32	13,75	3,33	6,20	A++	
	2,50	5,00	—	—	2,50	5,00	—	—	2,00	7,50	8,70	0,55	2,24	3,10	2,44	9,94	13,75	3,35	6,20	A++	
	2,50	7,10	—	—	2,14	5,36	—	—	2,00	7,50	8,70	0,55	2,24	3,10	2,44	9,94	13,75	3,35	6,20	A++	
	3,50	3,50	—	—	3,60	3,60	—	—	2,00	7,20	8,70	0,55	2,20	3,10	2,44	9,76	13,75	3,27	6,20	A++	
	3,50	4,20	—	—	3,38	4,13	—	—	2,00	7,50	8,70	0,55	2,26	3,20	2,44	10,03	14,20	3,32	6,20	A++	
	3,50	5,00	—	—	2,95	4,25	—	—	2,00	7,20	8,70	0,55	2,24	3,20	2,44	9,94	14,20	3,21	6,20	A++	
	3,50	7,10	—	—	2,67	4,83	—	—	2,00	7,50	8,70	0,55	2,25	3,20	2,44	9,98	14,20	3,33	6,20	A++	
	4,20	4,20	—	—	3,75	3,75	—	—	2,00	7,50	8,70	0,55	2,25	3,20	2,44	9,98	14,20	3,33	6,20	A++	
	4,20	5,00	—	—	3,44	4,06	—	—	2,00	7,50	8,70	0,55	2,25	3,20	2,44	9,98	14,20	3,33	6,20	A++	
	4,20	7,10	—	—	3,03	4,47	—	—	2,00	7,50	8,70	0,55	2,25	3,30	2,44	9,98	14,64	3,33	6,20	A++	
	5,00	5,00	—	—	3,75	3,75	—	—	2,00	7,50	8,70	0,55	2,18	3,30	2,44	9,67	14,64	3,44	6,20	A++	
	5,00	7,10	—	—	3,33	4,17	—	—	2,00	7,50	8,70	0,55	2,18	3,30	2,44	9,67	14,64	3,44	6,20	A++	
3	2,00	2,00	2,00	—	2,00	2,00	2,00	—	2,40	6,00	8,70	0,55	1,80	3,40	2,44	7,99	15,08	3,33	6,70	A++	
	2,00	2,00	2,50	—	2,00	2,00	2,60	—	2,40	6,60	8,70	0,55	1,95	3,40	2,44	8,65	15,08	3,38	6,70	A++	
	2,00	2,00	3,50	—	1,97	1,97	3,55	—	2,40	7,50	8,70	0,55	2,20	3,40	2,44	9,76	15,08	3,41	6,70	A++	
	2,00	2,00	4,20	—	1,79	1,79	3,93	—	2,40	7,50	8,70	0,55	2,20	3,40	2,44	9,76	15,08	3,41	6,70	A++	
	2,00	2,00	5,00	—	1,63	1,63	4,24	—	2,40	7,50	8,70	0,55	2,20	3,40	2,44	9,76	15,08	3,41	6,70	A++	
	2,00	2,00	7,10	—	1,43	1,43	4,64	—	2,40	7,50	8,70	0,55	2,15	3,40	2,44	9,54	15,08	3,49	6,70	A++	
	2,00	2,50	2,50	—	2,00	2,60	2,60	—	2,40	7,20	8,70	0,55	2,15	3,40	2,44	9,54	15,08	3,35	6,70	A++	
	2,00	2,50	3,50	—	1,83	2,38	3,29	—	2,40	7,50	8,70	0,55	2,15	3,40	2,44	9,54	15,08	3,49	6,70	A++	
	2,00	2,50	4,20	—	1,67	2,17	3,67	—	2,40	7,50	8,70	0,55	2,15	3,40	2,44	9,54	15,08	3,49	6,70	A++	
	2,00	2,50	5,00	—	1,53	1,99	3,98	—	2,40	7,50	8,70	0,55	2,15	3,40	2,44	9,54	15,08	3,49	6,70	A++	
	2,00	2,50	7,10	—	1,35	1,76	4,39	—	2,40	7,50	8,70	0,55	2,15	3,40	2,44	9,54	15,08	3,49	6,70	A++	
	2,00	3,50	3,50	—	1,63	2,93	2,93	—	2,40	7,50	8,70	0,55	2,15	3,40	2,44	9,54	15,08	3,49	6,70	A++	
	2,00	3,50	4,20	—	1,50	2,70	3,50	—	2,40	7,50	8,70	0,55	2,15	3,40	2,44	9,54	15,08	3,49	6,70	A++	
	2,00	3,50	5,00	—	1,39	2,50	3,61	—	2,40	7,50	8,70	0,55	2,15	3,40	2,44	9,54	15,08	3,49	6,70	A++	
	2,00	3,50	7,10	—	1,24	2,23	4,03	—	2,40	7,50	8,70	0,55	2,15	3,40	2,44	9,54	15,08	3,49	6,70	A++	
	2,00	4,20	4,20	—	1,39	3,06	3,06	—	2,40	7,50	8,70	0,55	2,15	3,40	2,44	9,54	15,08	3,49	6,70	A++	
	2,00	4,20	5,00	—	1,29	2,84	3,36	—	2,40	7,50	8,70	0,55	2,15	3,40	2,44	9,54	15,08	3,49	6,70	A++	
	2,00	4,20	7,10	—	1,16	2,56	3,78	—	2,40	7,50	8,70	0,55	2,15	3,40	2,44	9,54	15,08	3,49	6,70	A++	
	2,50	2,50	2,50	—	2,50	2,50	2,50	—	2,40	7,50	8,70	0,55	2,15	3,40	2,44	9,54	15,08	3,49	6,72	A++	
	2,50	2,50	3,50	—	2,22	2,22	3,07	—	2,40	7,50	8,70	0,55	2,15	3,40	2,44	9,54	15,08	3,49	6,72	A++	
	2,50	2,50	4,20	—	2,03	2,03	3,44	—	2,40	7,50	8,70	0,55	2,15	3,40	2,44	9,54	15,08	3,49	6,74	A++	
	2,50	2,50	5,00	—	1,88	1,88	3,75	—	2,40	7,50	8,70	0,55	2,15	3,40	2,44	9,54	15,08	3,49	6,74	A++	
	2,50	2,50	7,10	—	1,67	1,67	4,17	—	2,40	7,50	8,70	0,55	2,15	3,40	2,44	9,54	15,08	3,49	6,70	A++	
	2,50	3,50	3,50	—	1,99	2,76	2,76	—	2,40	7,50	8,70	0,55	2,08	3,40	2,44	9,23	15,08	3,61	6,73	A++	
	2,50	3,50	4,20	—	1,84	2,55	3,11	—	2,40	7,50	8,70	0,55	2,08	3,40	2,44	9,23	15,08	3,61	6,70	A++	
	2,50	3,50	5,00	—	1,71	2,37	3,42	—	2,40	7,50	8,70	0,55	2,08	3,40	2,44	9,23	15,08	3,61	6,70	A++	
	2,50	3,50	7,10	—	1,54	2,13	3,84	—	2,40	7,50	8,70	0,55	2,08	3,40	2,44	9,23	15,08	3,61	6,70	A++	
	2,50	4,20	4,20	—	1,71	2,89	2,89	—	2,40	7,50	8,70	0,55	2,08	3,40	2,44	9,23	15,08	3,61	6,70	A++	
	2,50	4,20	5,00	—	1,60	2,70	3,20	—	2,40	7,50	8,70	0,55	2,08	3,40	2,44	9,23	15,08	3,61	6,70	A++	
	3,50	3,50	3,50	—	2,50	2,50	2,50	—	2,40	7,50	8,70	0,55	2,08	3,40	2,44	9,23	15,08	3,61	6,75	A++	
	3,50	3,50	4,20	—	2,33	2,33	2,84	—	2,40	7,50	8,70	0,55	2,08	3,40	2,44	9,23	15,08	3,61	6,70	A++	
	3,50	3,50	5,00	—	2,18	2,18	3,15	—	2,40	7,50	8,70	0,55	2,08	3,40	2,44	9,23	15,08	3,61	6,70	A++	
4	2,00	2,00	2,00	2,00	1,88	1,88	1,88	1,88	2,40	7,50	8,70	0,55	2,12	3,40	2,44	9,41	15,08	3,54	6,80	A++	
	2,00	2,00	2,00	2,50	1,74	1,74	1,74	2,27	2,40	7,50	8,70	0,55	2,12	3,40	2,44	9,41	15,08	3,54	6,80	A++	
	2,00	2,00	2,00	3,50	1,56	1,56	1,56	2,81	2,40	7,50	8,70	0,55	2,12	3,40	2,44	9,41	15,08	3,54	6,80	A++	
	2,00	2,00	2,00	4,20	1,44	1,44	1,44	3,17	2,40	7,50	8,70	0,55	2,12	3,40	2,44	9,41	15,08	3,54	6,80	A++	
	2,00	2,00	2,00	5,00	1,34	1,34	1,34	3,48	2,40	7,50	8,70	0,55	2,02	3,40	2,44	8,96	15,08	3,71	6,80	A++	
	2,00	2,00	2,00	7,10	1,20	1,20	1,20	3,90	2,40	7,50	8,70	0,55	2,02	3,40	2,44	8,96	15,08	3,71	6,70	A++	
	2,00	2,00	2,50	2,50	1,63	1,63	2,12	2,12	2,40	7,50	8,70	0,55	2,02	3,40	2,44	8,96	15,08	3,71	6,80	A++	
	2,00	2,00	2,50	3,50	1,47	1,47	1,91	2,65	2,40	7,50	8,70	0,55	2,02	3,40	2,44	8,96	15,08	3,71	6,80	A++	
	2,00	2,00	2,50	4,20	1,36	1,36	1,77	3,00	2,40	7,50	8,70	0,55	2,02	3,40	2,44	8,96	15,08	3,71	6,80	A++	
	2,00	2,00	2,50	5,00	1,27	1,27	1,65	3,31	2,40	7,50	8,70	0,55	2,02	3,40	2,44	8,96	15,08	3,71	6,80	A++	
	2,00	2,00	2,50	7,10	1,15	1,15	1,49	3,72	2,40	7,50	8,70	0,55	2,02	3,40	2,44	8,96	15,08	3,71	6,70	A++	
	2,00	2,00	3,50	3,50	1,34	1,34	2,41	2,41	2,40	7,50	8,70	0,55	2,02	3,40	2,44	8,96	15,08	3,71	6,80	A++	
	2,00	2,00	3,50	4,20	1,25	1,25	2,25	2,75	2,40	7,50	8,70	0,55	2,02	3,40	2,44	8,96	15,08	3,71	6,70	A++	
	2,00	2,00	3,50	5,00	1,17	1,17	2,11	3,05	2,40	7,50	8,70	0,55	2,02	3,40	2,44	8,96	15,08	3,71	6,70	A++	
	2,00	2,00	4,20	4,20	1,17	1,17	2,58	2,58	2,40	7,50	8,70	0,55	2,02	3,40	2,44	8,96	15,08	3,71	7,00	A++	
	2,00	2,00	4,20	5,00	1,10	1,10	2,43	2,87</													

# COMBINATIONS TABLE

4U75S2SR5FA Inverter (The values in the table refer to the FLEXIS series)

HEATING																				
Combinations				Output power (kW)				System output power (kW)			Absorbed power (kW)			Absorbed current (A)			COP	SCOP	Energy class	
UI	A	B	C	A	B	C	min	nom	max	min	nom	max	min	nom	max	min	nom			
2	2,00	2,00	—	—	2,30	2,30	—	—	2,80	4,60	8,00	0,55	1,25	2,90	2,44	5,55	12,87	3,68	3,75	A
	2,00	2,50	—	—	2,30	3,60	—	—	2,80	5,90	9,00	0,55	1,59	2,90	2,44	7,05	12,87	3,71	3,75	A
	2,00	3,50	—	—	2,30	4,50	—	—	2,80	6,80	10,00	0,55	1,83	2,90	2,44	8,12	12,87	3,72	3,75	A
	2,00	4,20	—	—	2,30	5,40	—	—	3,10	7,70	10,00	0,55	2,05	2,90	2,44	9,09	12,87	3,76	3,80	A
	2,00	5,00	—	—	2,30	6,00	—	—	3,10	8,30	10,00	0,55	2,22	2,90	2,44	9,85	12,87	3,74	3,80	A
	2,00	7,10	—	—	2,13	6,47	—	—	3,10	8,60	10,00	0,55	2,30	2,90	2,44	10,20	12,87	3,74	3,85	A
	2,50	2,50	—	—	3,60	3,60	—	—	3,10	7,20	10,00	0,55	1,94	2,90	2,44	8,61	12,87	3,71	3,85	A
	2,50	3,50	—	—	3,60	4,50	—	—	3,10	8,10	10,00	0,55	2,12	2,90	2,44	9,41	12,87	3,82	3,83	A
	2,50	4,20	—	—	3,44	5,16	—	—	3,10	8,60	10,00	0,55	2,25	2,90	2,44	9,98	12,87	3,82	3,87	A
	2,50	5,00	—	—	3,23	5,38	—	—	3,10	8,60	10,00	0,55	2,22	2,90	2,44	9,85	12,87	3,87	3,85	A
	2,50	7,10	—	—	2,92	5,68	—	—	3,10	8,60	10,00	0,55	2,22	2,90	2,44	9,85	12,87	3,87	3,84	A
	3,50	3,50	—	—	4,30	4,30	—	—	3,10	8,60	10,00	0,55	2,22	2,90	2,44	9,85	12,87	3,87	3,86	A
	3,50	4,20	—	—	3,91	4,69	—	—	3,10	8,60	10,00	0,55	2,22	3,00	2,44	9,85	13,31	3,87	3,82	A
	3,50	5,00	—	—	3,51	4,69	—	—	3,10	8,20	10,00	0,55	2,10	3,00	2,44	9,32	13,31	3,90	3,80	A
	3,50	7,10	—	—	3,37	5,23	—	—	3,10	8,60	10,00	0,55	2,20	3,00	2,44	9,76	13,31	3,91	3,84	A
	4,20	4,20	—	—	4,30	4,30	—	—	3,10	8,60	10,00	0,55	2,20	3,10	2,44	9,76	13,75	3,91	3,86	A
	4,20	5,00	—	—	4,07	4,53	—	—	3,10	8,60	10,00	0,55	2,19	3,10	2,44	9,72	13,75	3,93	3,83	A
	4,20	7,10	—	—	3,75	4,85	—	—	3,10	8,60	10,00	0,55	2,19	3,10	2,44	9,72	13,75	3,93	3,86	A
	5,00	5,00	—	—	4,30	4,30	—	—	3,10	8,60	10,00	0,55	2,19	3,10	2,44	9,72	13,75	3,93	3,86	A
	5,00	7,10	—	—	3,97	4,63	—	—	3,10	8,60	10,00	0,55	2,19	3,10	2,44	9,72	13,75	3,93	3,87	A
3	2,00	2,00	2,00	—	2,30	2,30	2,30	—	3,10	6,90	9,50	0,55	1,85	3,10	2,44	8,21	13,75	3,73	3,80	A
	2,00	2,00	2,50	—	2,30	2,30	3,60	—	3,10	8,20	10,00	0,55	2,16	3,10	2,44	9,58	13,75	3,80	3,80	A
	2,00	2,00	3,50	—	2,17	2,17	4,25	—	3,10	8,60	10,00	0,55	2,26	3,10	2,44	10,03	13,75	3,81	3,80	A
	2,00	2,00	4,20	—	1,98	1,98	4,64	—	3,10	8,60	10,00	0,55	2,25	3,10	2,44	9,98	13,75	3,82	3,80	A
	2,00	2,00	5,00	—	1,87	1,87	4,87	—	3,10	8,60	10,00	0,55	2,25	3,10	2,44	9,98	13,75	3,82	3,80	A
	2,00	2,00	7,10	—	1,71	1,71	5,19	—	3,10	8,60	10,00	0,55	2,25	3,10	2,44	9,98	13,75	3,82	3,80	A
	2,00	2,50	2,50	—	2,08	3,26	3,26	—	3,10	8,60	10,00	0,55	2,25	3,10	2,44	9,98	13,75	3,82	3,80	A
	2,00	2,50	3,50	—	1,90	2,98	3,72	—	3,10	8,60	10,00	0,55	2,25	3,10	2,44	9,98	13,75	3,82	3,80	A
	2,00	2,50	4,20	—	1,75	2,74	4,11	—	3,10	8,60	10,00	0,55	2,25	3,10	2,44	9,98	13,75	3,82	3,80	A
	2,00	2,50	5,00	—	1,66	2,60	4,34	—	3,10	8,60	10,00	0,55	2,25	3,10	2,44	9,98	13,75	3,82	3,82	A
	2,00	2,50	7,10	—	1,53	2,40	4,67	—	3,10	8,60	10,00	0,55	2,25	3,10	2,44	9,98	13,75	3,82	3,82	A
	2,00	3,50	3,50	—	1,75	3,42	3,42	—	3,10	8,60	10,00	0,55	2,23	3,10	2,44	9,89	13,75	3,86	3,82	A
	2,00	3,50	4,20	—	1,62	3,17	3,81	—	3,10	8,60	10,00	0,55	2,23	3,10	2,44	9,89	13,75	3,86	3,82	A
	2,00	3,50	5,00	—	1,55	3,02	4,03	—	3,10	8,60	10,00	0,55	2,23	3,10	2,44	9,89	13,75	3,86	3,82	A
	2,00	3,50	7,10	—	1,43	2,80	4,36	—	3,10	8,60	10,00	0,55	2,23	3,10	2,44	9,89	13,75	3,86	3,82	A
	2,00	4,20	4,20	—	1,51	3,55	3,55	—	3,10	8,60	10,00	0,55	2,23	3,10	2,44	9,89	13,75	3,86	3,82	A
	2,00	4,20	5,00	—	1,44	3,39	3,77	—	3,10	8,60	10,00	0,55	2,23	3,10	2,44	9,89	13,75	3,86	3,82	A
	2,00	4,20	7,10	—	1,35	3,16	4,10	—	3,10	8,60	10,00	0,55	2,23	3,10	2,44	9,89	13,75	3,86	3,87	A
	2,50	2,50	2,50	—	2,87	2,87	2,87	—	3,10	8,60	10,00	0,55	2,23	3,10	2,44	9,89	13,75	3,86	3,87	A
	2,50	2,50	3,50	—	2,65	2,65	3,31	—	3,10	8,60	10,00	0,55	2,23	3,10	2,44	9,89	13,75	3,86	3,87	A
	2,50	2,50	4,20	—	2,46	2,46	3,69	—	3,10	8,60	10,00	0,55	2,23	3,10	2,44	9,89	13,75	3,86	3,87	A
	2,50	2,50	5,00	—	2,35	2,35	3,91	—	3,10	8,60	10,00	0,55	2,23	3,10	2,44	9,89	13,75	3,86	3,87	A
	2,50	2,50	7,10	—	2,18	2,18	4,24	—	3,10	8,60	10,00	0,55	2,23	3,10	2,44	9,89	13,75	3,86	3,90	A
	2,50	3,50	3,50	—	2,46	3,07	3,07	—	3,10	8,60	10,00	0,55	2,19	3,10	2,44	9,72	13,75	3,93	3,85	A
	2,50	3,50	4,20	—	2,29	2,87	3,44	—	3,10	8,60	10,00	0,55	2,19	3,10	2,44	9,72	13,75	3,93	3,85	A
	2,50	3,50	5,00	—	2,20	2,74	3,66	—	3,10	8,60	10,00	0,55	2,19	3,10	2,44	9,72	13,75	3,93	3,85	A
	2,50	3,50	7,10	—	2,05	2,56	3,99	—	3,10	8,60	10,00	0,55	2,18	3,10	2,44	9,67	13,75	3,94	3,85	A
	2,50	4,20	4,20	—	2,15	3,23	3,23	—	3,10	8,60	10,00	0,55	2,18	3,10	2,44	9,67	13,75	3,94	3,85	A
	2,50	4,20	5,00	—	2,06	3,10	3,44	—	3,10	8,60	10,00	0,55	2,18	3,10	2,44	9,67	13,75	3,94	3,85	A
	3,50	3,50	3,50	—	2,87	2,87	2,87	—	3,10	8,60	10,00	0,55	2,18	3,10	2,44	9,67	13,75	3,94	3,90	A
	3,50	3,50	4,20	—	2,69	2,69	3,23	—	3,10	8,60	10,00	0,55	2,18	3,10	2,44	9,67	13,75	3,94	3,90	A
	3,50	3,50	5,00	—	2,58	2,58	3,44	—	3,10	8,60	10,00	0,55	2,18	3,10	2,44	9,67	13,75	3,94	3,90	A
4	2,00	2,00	2,00	2,00	2,15	2,15	2,15	2,15	3,10	8,60	10,00	0,55	2,25	3,10	2,44	9,98	13,75	3,82	3,85	A
	2,00	2,00	2,00	2,50	1,88	1,88	1,88	2,95	3,10	8,60	10,00	0,55	2,22	3,10	2,44	9,85	13,75	3,87	3,85	A
	2,00	2,00	2,00	3,50	1,74	1,74	1,74	3,39	3,10	8,60	10,00	0,55	2,22	3,10	2,44	9,85	13,75	3,87	3,85	A
	2,00	2,00	2,00	4,20	1,61	1,61	1,61	3,78	3,10	8,60	10,00	0,55	2,19	3,10	2,44	9,72	13,75	3,93	3,85	A
	2,00	2,00	2,00	5,00	1,53	1,53	1,53	4,00	3,10	8,60	10,00	0,55	2,19	3,10	2,44	9,72	13,75	3,93	3,85	A
	2,00	2,00	2,00	7,10	1,42	1,42	1,42	4,33	3,10	8,60	10,00	0,55	2,19	3,10	2,44	9,72	13,75	3,93	3,85	A
	2,00	2,00	2,50	2,50	1,68	1,68	2,62	2,62	3,10	8,60	10,00	0,55	2,19	3,10	2,44	9,72	13,75	3,93	3,85	A
	2,00	2,00	2,50	3,50	1,56	1,56	2,44	3,05	3,10	8,60	10,00	0,55	2,19	3,10	2,44	9,72	13,75	3,93	3,85	A

4U85S2SR5FA Inverter (The values in the table refer to the FLEXIS series)

COOLING																				
Combinations				Output power (kW)				System output power (kW)			Absorbed power (kW)			Absorbed current (A)			EER	SEER	Energy class	
UI	A	B	C	D	A	B	C	D	min	nom	max	min	nom	max	min	nom	max	EER	SEER	Energy class
2	2,00	2,00	—	—	2,00	2,00	—	—	2,50	4,00	5,60	0,55	1,30	3,20	2,44	5,77	14,20	3,08	6,20	A++
	2,00	2,50	—	—	2,00	2,60	—	—	2,50	4,60	6,70	0,55	1,50	3,20	2,44	6,65	14,20	3,07	6,20	A++
	2,00	3,50	—	—	2,00	3,60	—	—	2,50	5,60	8,10	0,55	1,80	3,20	2,44	7,99	14,20	3,11	6,20	A++
	2,00	4,20	—	—	2,00	4,40	—	—	2,50	6,40	7,80	0,55	2,05	3,20	2,44	9,09	14,20	3,12	6,20	A++
	2,00	5,00	—	—	2,00	5,20	—	—	2,50	7,20	9,30	0,55	2,28	3,20	2,44	10,12	14,20	3,16	6,20	A++
	2,00	7,10	—	—	2,00	6,50	—	—	2,50	8,50	9,30	0,55	2,65	3,30	2,44	11,76	14,64	3,21	6,20	A++
	2,50	2,50	—	—	2,60	2,60	—	—	2,50	5,20	7,80	0,55	1,60	3,30	2,44	7,10	14,64	3,25	6,20	A++
	2,50	3,50	—	—	2,60	3,60	—	—	2,50	6,20	9,10	0,55	1,98	3,30	2,44	8,78	14,64	3,13	6,20	A++
	2,50	4,20	—	—	2,60	4,40	—	—	2,50	7,00	9,30	0,55	2,20	3,30	2,44	9,76	14,64	3,18	6,20	A++
	2,50	5,00	—	—	2,60	5,20	—	—	2,50	7,80	9,30	0,55	2,35	3,30	2,44	10,43	14,64	3,32	6,20	A++
	2,50	7,10	—	—	2,43	6,07	—	—	2,50	8,50	9,30	0,55	2,60	3,30	2,44	11,54	14,64	3,27	6,20	A++
	3,50	3,50	—	—	3,60	3,60	—	—	2,50	7,20	9,30	0,55	2,20	3,30	2,44	9,76	14,64	3,27	6,20	A++
	3,50	4,20	—	—	3,60	4,40	—	—	2,50	8,00	9,30	0,55	2,42	3,30	2,44	10,74	14,64	3,31	6,20	A++
	3,50	5,00	—	—	3,51	4,79	—	—	2,50	8,10	9,50	0,55	2,52	3,30	2,44	11,18	14,64	3,21	6,20	A++
	3,50	7,10	—	—	3,03	5,47	—	—	2,50	8,50	9,50	0,55	2,59	3,30	2,44	11,49	14,64	3,28	6,20	A++
	4,20	4,20	—	—	4,25	4,25	—	—	2,50	8,50	9,50	0,55	2,59	3,30	2,44	11,49	14,64	3,28	6,20	A++
	4,20	5,00	—	—	3,90	4,60	—	—	2,50	8,50	9,50	0,55	2,59	3,30	2,44	11,49	14,64	3,28	6,20	A++
	4,20	7,10	—	—	3,43	5,07	—	—	2,50	8,50	9,50	0,55	2,58	3,30	2,44	11,45	14,64	3,29	6,20	A++
	5,00	5,00	—	—	4,25	4,25	—	—	2,50	8,50	9,50	0,55	2,56	3,30	2,44	11,36	14,64	3,32	6,20	A++
	5,00	7,10	—	—	3,78	4,72	—	—	2,50	8,50	9,50	0,55	2,55	3,30	2,44	11,31	14,64	3,33	6,20	A++
	7,10	7,10	—	—	4,25	4,25	—	—	2,50	8,50	9,50	0,55	2,55	3,30	2,44	11,31	14,64	3,33	6,20	A++
3	2,00	2,00	2,00	—	2,00	2,00	2,00	—	3,00	6,00	9,50	0,55	1,85	3,50	2,44	8,21	15,53	3,24	6,70	A++
	2,00	2,00	2,50	—	2,00	2,00	2,60	—	3,00	6,60	9,50	0,55	2,00	3,50	2,44	8,87	15,53	3,30	6,70	A++
	2,00	2,00	3,50	—	2,00	2,00	3,60	—	3,00	7,60	9,50	0,55	2,30	3,50	2,44	10,20	15,53	3,30	6,70	A++
	2,00	2,00	4,20	—	2,00	2,00	4,40	—	3,20	8,40	9,50	0,55	2,56	3,50	2,44	11,36	15,53	3,28	6,70	A++
	2,00	2,00	5,00	—	1,85	1,85	4,80	—	3,20	8,50	9,50	0,55	2,57	3,50	2,44	11,40	15,53	3,31	6,70	A++
	2,00	2,00	7,10	—	1,62	1,62	5,26	—	3,20	8,50	9,50	0,55	2,57	3,50	2,44	11,40	15,53	3,31	6,70	A++
	2,00	2,50	2,50	—	2,00	2,60	2,60	—	3,20	7,20	9,50	0,55	2,20	3,50	2,44	9,76	15,53	3,27	6,70	A++
	2,00	2,50	3,50	—	2,00	2,60	3,60	—	3,20	8,20	9,50	0,55	2,50	3,50	2,44	11,09	15,53	3,28	6,70	A++
	2,00	2,50	4,20	—	1,89	2,46	4,16	—	3,20	8,50	9,50	0,55	2,56	3,50	2,44	11,36	15,53	3,32	6,70	A++
	2,00	2,50	5,00	—	1,73	2,26	4,51	—	3,20	8,50	9,50	0,55	2,56	3,50	2,44	11,36	15,53	3,32	6,70	A++
	2,00	2,50	7,10	—	1,53	1,99	4,98	—	3,20	8,50	9,50	0,55	2,56	3,50	2,44	11,36	15,53	3,32	6,70	A++
	2,00	3,50	3,50	—	1,85	3,33	3,33	—	3,20	8,50	9,50	0,55	2,56	3,50	2,44	11,36	15,53	3,32	6,70	A++
	2,00	3,50	4,20	—	1,70	3,06	3,74	—	3,20	8,50	9,50	0,55	2,56	3,50	2,44	11,36	15,53	3,32	6,70	A++
	2,00	3,50	5,00	—	1,57	2,83	4,09	—	3,20	8,50	9,50	0,55	2,56	3,50	2,44	11,36	15,53	3,32	6,70	A++
	2,00	3,50	7,10	—	1,40	2,53	4,57	—	3,20	8,50	9,50	0,55	2,56	3,50	2,44	11,36	15,53	3,32	6,70	A++
	2,00	4,20	4,20	—	1,57	3,46	3,46	—	3,20	8,50	9,50	0,55	2,56	3,50	2,44	11,36	15,53	3,32	6,70	A++
	2,00	4,20	5,00	—	1,47	3,22	3,81	—	3,20	8,50	9,50	0,55	2,56	3,50	2,44	11,36	15,53	3,32	6,70	A++
	2,00	4,20	7,10	—	1,32	2,90	4,28	—	3,20	8,50	9,50	0,55	2,56	3,50	2,44	11,36	15,53	3,32	6,70	A++
	2,00	5,00	5,00	—	1,37	3,56	3,56	—	3,20	8,50	9,50	0,55	2,56	3,50	2,44	11,36	15,53	3,32	6,70	A++
	2,50	2,50	2,50	—	2,60	2,60	2,60	—	3,20	7,80	9,50	0,55	2,35	3,50	2,44	10,43	15,53	3,32	6,72	A++
	2,50	2,50	3,50	—	2,51	2,51	3,48	—	3,20	8,50	9,50	0,55	2,55	3,50	2,44	11,31	15,53	3,33	6,72	A++
	2,50	2,50	4,20	—	2,30	2,30	3,90	—	3,20	8,50	9,50	0,55	2,55	3,50	2,44	11,31	15,53	3,33	6,74	A++
	2,50	2,50	5,00	—	2,13	2,13	4,25	—	3,20	8,50	9,50	0,55	2,55	3,50	2,44	11,31	15,53	3,33	6,74	A++
	2,50	2,50	7,10	—	1,89	1,89	4,72	—	3,20	8,50	9,50	0,55	2,55	3,50	2,44	11,31	15,53	3,33	6,70	A++
	2,50	3,50	3,50	—	2,26	3,12	3,12	—	3,20	8,50	9,50	0,55	2,55	3,50	2,44	11,31	15,53	3,33	6,73	A++
	2,50	3,50	4,20	—	2,08	2,89	3,53	—	3,20	8,50	9,50	0,55	2,55	3,50	2,44	11,31	15,53	3,33	6,70	A++
	2,50	3,50	5,00	—	1,94	2,68	3,88	—	3,20	8,50	9,50	0,55	2,55	3,50	2,44	11,31	15,53	3,33	6,70	A++
	2,50	3,50	7,10	—	1,74	2,41	4,35	—	3,20	8,50	9,50	0,55	2,55	3,50	2,44	11,31	15,53	3,33	6,70	A++
	2,50	4,20	4,20	—	1,94	3,28	3,28	—	3,20	8,50	9,50	0,55	2,55	3,50	2,44	11,31	15,53	3,33	6,70	A++
	2,50	4,20	5,00	—	1,81	3,07	3,62	—	3,20	8,50	9,50	0,55	2,55	3,50	2,44	11,31	15,53	3,33	6,70	A++
	2,50	4,20	7,10	—	1,64	2,77	4,09	—	3,20	8,50	9,50	0,55	2,55	3,50	2,44	11,31	15,53	3,33	6,70	A++
	2,50	5,00	5,00	—	1,70	3,40	3,40	—	3,20	8,50	9,50	0,55	2,55	3,50	2,44	11,31	15,53	3,33	6,70	A++
	3,50	3,50	3,50	—	2,83	2,83	2,83	—	3,20	8,50	9,50	0,55	2,53	3,50	2,44	11,22	15,53	3,36	6,75	A++
	3,50	3,50	4,20	—	2,64	2,64	3,22	—	3,20	8,50	9,50	0,55	2,53	3,50	2,44	11,22	15,53	3,36	6,70	A++
	3,50	3,50	5,00	—	2,47	2,47	3,56	—	3,20	8,50	9,50	0,55	2,53	3,50	2,44	11,22	15,53	3,36	6,70	A++
	3,50	3,50	7,10	—	2,23	2,23	4,03	—	3,20	8,50	9,50	0,55	2,53	3,50	2,44	11,22	15,53	3,36	6,70	A++
	3,50	4,20	4,20	—	2,47	3,02	3,02	—	3,20	8,50	9,50	0,55	2,53	3,50	2,44	11,22	15,53	3,36	6,75	A++
	3,50	4,20	5,00	—	2,32	2,83	3,35	—	3,20	8,50	9,50	0,55	2,53	3,50	2,44	11,22	15,53	3,36	6,75	A++
	3,50	5,00	5,00	—	2,19	3,16	3,16	—	3,20	8,50	9,50	0,55	2,53	3,50	2,44	11,22	15,53	3,36	6,75	A++
	4,20	4,20	4,20	—	2,83	2,83	2,83	—	3,20	8,50	9,50	0,55	2,53	3,50	2,44	11,22	15,53	3,36	6,75	A++
	4,20	4,20	5,00	—	2,67	2,67	3,16	—	3,20	8,50	9,50	0,55	2,53	3,50	2,44	11,22	15,53	3,36	6,75	A++
	2,00	2,00	2,00	2,00	2,00	2,00	2,00	2,00	3,20	8,00	9,50	0,55	2,43	3,50	2,44	10,78	15,53	3,29	6,80	A++
	2,00	2,00	2,00	2,50	1,98	1,98	1,98	2,57	3,20	8,50	9,50	0,55	2,55	3,50	2,44	11,31	15,53	3,33	6,80	A++
	2,00	2,00	2,00	3,50	1,77	1,77	1,77	3,19	3,20	8,50	9,50	0,55	2,54	3,50	2,44	11,27	15,53	3,35	6,80	A++
	2,00	2,00	2,00	4,20	1,63	1,63	1,63	3,60	3,20	8,50	9,50	0,55	2,54	3,50	2,44	11,27	15,53	3,35	6,80	A++
	2,00	2,00	2,00	5,00	1,52	1,52	1,52	3,95	3,20	8,50	9,50	0,55	2,54	3,50	2,44	11,27	15,53	3,35	6,80	A++
	2,00	2,00	2,00	7,10	1,36	1,36	1,36	4,42	3,20	8,50										

# COMBINATIONS TABLE

4U85S2SR5FA Inverter (The values in the table refer to the FLEXIS series)

HEATING																					
UI	Combinations				Output power (kW)				System output power (kW)			Absorbed power (kW)			Absorbed current (A)			COP	SCOP	Energy class	
	A	B	C	D	A	B	C	D	min	nom	max	min	nom	max	min	nom	max				
2	2.00	2.00	—	—	2.30	2.30	—	—	2.80	4.60	8.00	0.55	1.25	3.30	2.44	5.55	14.64	3.68	3.75	A	
	2.00	2.50	—	—	2.30	3.60	—	—	3.00	5.90	10.00	0.55	1.59	3.30	2.44	7.05	14.64	3.71	3.75	A	
	2.00	3.50	—	—	2.30	4.50	—	—	3.20	6.80	10.00	0.55	1.83	3.30	2.44	8.12	14.64	3.72	3.75	A	
	2.00	4.20	—	—	2.30	5.40	—	—	3.40	7.70	10.00	0.55	2.05	3.30	2.44	9.09	14.64	3.76	3.80	A	
	2.00	5.00	—	—	2.30	6.00	—	—	3.80	8.30	10.50	0.55	2.22	3.30	2.44	9.85	14.64	3.74	3.80	A	
	2.00	7.10	—	—	2.30	7.00	—	—	4.00	9.30	10.50	0.55	2.50	3.30	2.44	11.09	14.64	3.72	3.85	A	
	2.50	2.50	—	—	3.60	3.60	—	—	3.40	7.20	10.50	0.55	1.94	3.30	2.44	8.61	14.64	3.71	3.85	A	
	2.50	3.50	—	—	3.60	4.50	—	—	3.80	8.10	10.50	0.55	2.10	3.30	2.44	9.32	14.64	3.86	3.85	A	
	2.50	4.20	—	—	3.60	5.40	—	—	4.00	9.00	10.50	0.55	2.30	3.30	2.44	10.20	14.64	3.91	3.87	A	
	2.50	5.00	—	—	3.60	6.00	—	—	4.40	9.60	10.50	0.55	2.50	3.30	2.44	11.09	14.64	3.84	3.85	A	
	2.50	7.10	—	—	3.26	6.34	—	—	4.40	9.60	10.50	0.55	2.55	3.30	2.44	11.31	14.64	3.76	3.84	A	
	3.50	3.50	—	—	4.50	4.50	—	—	4.00	9.00	10.50	0.55	2.35	3.30	2.44	10.43	14.64	3.83	3.86	A	
	3.50	4.20	—	—	4.36	5.24	—	—	4.40	9.60	10.50	0.55	2.50	3.30	2.44	11.09	14.64	3.84	3.82	A	
	3.50	5.00	—	—	3.86	5.14	—	—	4.40	9.00	10.50	0.55	2.37	3.30	2.44	10.51	14.64	3.80	3.80	A	
	3.50	7.10	—	—	3.76	5.84	—	—	4.40	9.60	10.50	0.55	2.50	3.30	2.44	11.09	14.64	3.84	3.84	A	
	4.20	4.20	—	—	4.80	4.80	—	—	4.40	9.60	10.50	0.55	2.49	3.30	2.44	11.05	14.64	3.86	3.86	A	
	4.20	5.00	—	—	4.55	5.05	—	—	4.40	9.60	10.50	0.55	2.49	3.30	2.44	11.05	14.64	3.86	3.83	A	
	4.20	7.10	—	—	4.18	5.42	—	—	4.40	9.60	10.50	0.55	2.48	3.30	2.44	11.00	14.64	3.87	3.86	A	
	5.00	5.00	—	—	4.80	4.80	—	—	4.40	9.60	10.50	0.55	2.46	3.30	2.44	10.91	14.64	3.90	3.86	A	
	5.00	7.10	—	—	4.43	5.17	—	—	4.40	9.60	10.50	0.55	2.48	3.30	2.44	11.00	14.64	3.87	3.87	A	
7.10	7.10	—	—	4.80	4.80	—	—	4.40	9.60	10.50	0.55	2.50	3.30	2.44	11.09	14.64	3.84	3.85	A		
3	2.00	2.00	2.00	—	2.30	2.30	2.30	—	3.80	6.90	10.50	0.55	1.85	3.40	2.44	8.21	15.08	3.73	3.80	A	
	2.00	2.00	2.50	—	2.30	2.30	3.60	—	4.00	8.20	10.50	0.55	2.16	3.40	2.44	9.58	15.08	3.80	3.80	A	
	2.00	2.00	3.50	—	2.30	2.30	4.50	—	4.20	9.10	10.50	0.55	2.39	3.40	2.44	10.60	15.08	3.81	3.80	A	
	2.00	2.00	4.20	—	2.21	2.21	5.18	—	4.40	9.60	10.50	0.55	2.48	3.40	2.44	11.00	15.08	3.87	3.80	A	
	2.00	2.00	5.00	—	2.08	2.08	5.43	—	4.40	9.60	10.50	0.55	2.48	3.40	2.44	11.00	15.08	3.87	3.80	A	
	2.00	2.00	7.10	—	1.90	1.90	5.79	—	4.40	9.60	10.50	0.55	2.50	3.40	2.44	11.09	15.08	3.84	3.80	A	
	2.00	2.50	2.50	—	2.32	3.64	3.64	—	4.40	9.60	10.50	0.55	2.54	3.40	2.44	11.27	15.08	3.78	3.80	A	
	2.00	2.50	3.50	—	2.12	3.32	4.15	—	4.40	9.60	10.50	0.55	2.48	3.40	2.44	11.00	15.08	3.87	3.80	A	
	2.00	2.50	4.20	—	1.95	3.06	4.59	—	4.40	9.60	10.50	0.55	2.48	3.40	2.44	11.00	15.08	3.87	3.80	A	
	2.00	2.50	5.00	—	1.86	2.90	4.84	—	4.40	9.60	10.50	0.55	2.47	3.40	2.44	10.96	15.08	3.89	3.82	A	
	2.00	2.50	7.10	—	1.71	2.68	5.21	—	4.40	9.60	10.50	0.55	2.50	3.40	2.44	11.09	15.08	3.84	3.82	A	
	2.00	3.50	3.50	—	1.95	3.82	3.82	—	4.40	9.60	10.50	0.55	2.52	3.40	2.44	11.18	15.08	3.81	3.82	A	
	2.00	3.50	4.20	—	1.81	3.54	4.25	—	4.40	9.60	10.50	0.55	2.46	3.40	2.44	10.91	15.08	3.90	3.82	A	
	2.00	3.50	5.00	—	1.73	3.38	4.50	—	4.40	9.60	10.50	0.55	2.46	3.40	2.44	10.91	15.08	3.90	3.82	A	
	2.00	3.50	7.10	—	1.60	3.13	4.87	—	4.40	9.60	10.50	0.55	2.46	3.40	2.44	10.91	15.08	3.90	3.82	A	
	2.00	4.20	4.20	—	1.69	3.96	3.96	—	4.40	9.60	10.50	0.55	2.46	3.40	2.44	10.91	15.08	3.90	3.82	A	
	2.00	4.20	5.00	—	1.61	3.78	4.20	—	4.40	9.60	10.50	0.55	2.46	3.40	2.44	10.91	15.08	3.90	3.82	A	
	2.00	4.20	7.10	—	1.50	3.53	4.57	—	4.40	9.60	10.50	0.55	2.46	3.40	2.44	10.91	15.08	3.90	3.87	A	
	2.00	5.00	5.00	—	1.54	4.03	4.03	—	4.40	9.60	10.50	0.55	2.46	3.40	2.44	10.91	15.08	3.90	3.87	A	
	2.50	2.50	2.50	—	3.20	3.20	3.20	—	4.40	9.60	10.50	0.55	2.45	3.40	2.44	10.87	15.08	3.92	3.87	A	
	2.50	2.50	3.50	—	2.95	2.95	3.69	—	4.40	9.60	10.50	0.55	2.45	3.40	2.44	10.87	15.08	3.92	3.87	A	
	2.50	2.50	4.20	—	2.74	2.74	4.11	—	4.40	9.60	10.50	0.55	2.45	3.40	2.44	10.87	15.08	3.92	3.87	A	
	2.50	2.50	5.00	—	2.62	2.62	4.36	—	4.40	9.60	10.50	0.55	2.45	3.40	2.44	10.87	15.08	3.92	3.87	A	
	2.50	2.50	7.10	—	2.43	2.43	4.73	—	4.40	9.60	10.50	0.55	2.45	3.40	2.44	10.87	15.08	3.92	3.90	A	
	2.50	3.50	3.50	—	2.74	3.43	3.43	—	4.40	9.60	10.50	0.55	2.45	3.40	2.44	10.87	15.08	3.92	3.85	A	
	2.50	3.50	4.20	—	2.56	3.20	3.84	—	4.40	9.60	10.50	0.55	2.45	3.40	2.44	10.87	15.08	3.92	3.85	A	
	2.50	3.50	5.00	—	2.45	3.06	4.09	—	4.40	9.60	10.50	0.55	2.45	3.40	2.44	10.87	15.08	3.92	3.85	A	
	2.50	3.50	7.10	—	2.29	2.86	4.45	—	4.40	9.60	10.50	0.55	2.45	3.40	2.44	10.87	15.08	3.92	3.85	A	
	2.50	4.20	4.20	—	2.40	3.60	3.60	—	4.40	9.60	10.50	0.55	2.45	3.40	2.44	10.87	15.08	3.92	3.85	A	
	2.50	4.20	5.00	—	2.30	3.46	3.84	—	4.40	9.60	10.50	0.55	2.45	3.40	2.44	10.87	15.08	3.92	3.85	A	
	2.50	4.20	7.10	—	2.16	3.24	4.20	—	4.40	9.60	10.50	0.55	2.45	3.40	2.44	10.87	15.08	3.92	3.85	A	
	2.50	5.00	5.00	—	2.22	3.69	3.69	—	4.40	9.60	10.50	0.55	2.45	3.40	2.44	10.87	15.08	3.92	3.85	A	
	3.50	3.50	3.50	—	3.20	3.20	3.20	—	4.40	9.60	10.50	0.55	2.45	3.40	2.44	10.87	15.08	3.92	3.90	A	
	3.50	3.50	4.20	—	3.00	3.00	3.60	—	4.40	9.60	10.50	0.55	2.45	3.40	2.44	10.87	15.08	3.92	3.90	A	
	3.50	3.50	5.00	—	2.88	2.88	3.84	—	4.40	9.60	10.50	0.55	2.43	3.40	2.44	10.78	15.08	3.95	3.90	A	
	3.50	3.50	7.10	—	2.70	2.70	4.20	—	4.40	9.60	10.50	0.55	2.43	3.40	2.44	10.78	15.08	3.95	3.85	A	
	3.50	4.20	4.20	—	2.82	3.39	3.39	—	4.40	9.60	10.50	0.55	2.43	3.40	2.44	10.78	15.08	3.95	3.90	A	
	3.50	4.20	5.00	—	2.72	3.26	3.62	—	4.40	9.60	10.50	0.55	2.43	3.40	2.44	10.78	15.08	3.95	3.90	A	
	3.50	5.00	5.00	—	2.62	3.49	3.49	—	4.40	9.60	10.50	0.55	2.43	3.40	2.44	10.78	15.08	3.95	3.90	A	
	4.20	4.20	4.20	—	3.20	3.20	3.20	—	4.40	9.60	10.50	0.55	2.43	3.40	2.44	10.78	15.08	3.95	3.90	A	
4.20	4.20	5.00	—	3.09	3.09	3.43	—	4.40	9.60	10.50	0.55	2.43	3.40	2.44	10.78	15.08	3.95	3.90	A		
4	2.00	2.00	2.00	2.00	2.30	2.30	2.30	2.30	4.20	9.20	10.50	0.55	2.42	3.40	2.44	10.74	15.08	3.80	3.85	A	
	2.00	2.00	2.00	2.50	2.10	2.10	2.10	3.29	4.20	9.60	10.50	0.55	2.44	3.40	2.44	10.83	15.08	3.93	3.85	A	
	2.00	2.00	2.00	3.50	1.94	1.94	1.94	3.79	4.40	9.60	10.50	0.55	2.44	3.40	2.44	10.83	15.08	3.93	3.85	A	
	2.00	2.00	2.00	4.20	1.80	1.80	1.80	4.21	4.40	9.60	10.50	0.55	2.44	3.40	2.44	10.83	15.08	3.93	3.85	A	
	2.00	2.00	2.00	5.00	1.71	1.71	1.71	4.47	4.40	9.60	10.50	0.55	2.44	3.40	2.44	10.83	15.08	3.93	3.85	A	
	2.00	2.00	2.00	7.10	1.59	1.59															



5U90S2SS5FA Inverter (The values in the table refer to the FLEXIS series)

COOLING																						
Combinations					Output power (kW)					System output power (kW)			Absorbed power (kW)			Absorbed current (A)			EER	SEER	Energy class	
UI	A	B	C	D	E	A	B	C	D	E	min	nom	max	min	nom	max	min	nom	max			
2	2,00	2,00	—	—	—	2,00	2,00	—	—	—	2,50	4,00	5,60	0,55	1,50	3,60	2,44	6,65	15,97	—	—	—
	2,00	2,50	—	—	—	2,00	2,60	—	—	—	2,50	4,60	6,70	0,55	1,67	3,60	2,44	7,41	15,97	2,75	6,20	A++
	2,00	3,50	—	—	—	2,00	3,60	—	—	—	2,50	5,60	8,10	0,55	2,03	3,60	2,44	9,01	15,97	2,76	6,20	A++
	2,00	4,20	—	—	—	2,00	4,40	—	—	—	2,50	6,40	7,80	0,55	2,30	3,60	2,44	10,20	15,97	2,78	6,20	A++
	2,00	5,00	—	—	—	2,00	5,20	—	—	—	2,50	7,20	9,30	0,55	2,58	3,60	2,44	11,45	15,97	2,79	6,20	A++
	2,00	7,10	—	—	—	2,00	6,50	—	—	—	2,50	8,50	9,30	0,55	2,95	3,60	2,44	13,09	15,97	2,88	6,20	A++
	2,50	2,50	—	—	—	2,60	2,60	—	—	—	2,50	5,20	7,80	0,55	1,89	3,60	2,44	8,39	15,97	2,75	6,20	A++
	2,50	3,50	—	—	—	2,60	3,60	—	—	—	2,50	6,20	9,10	0,55	2,23	3,60	2,44	9,89	15,97	2,78	6,20	A++
	2,50	4,20	—	—	—	2,60	4,40	—	—	—	2,50	7,00	9,30	0,55	2,51	3,60	2,44	11,14	15,97	2,79	6,20	A++
	2,50	5,00	—	—	—	2,60	5,20	—	—	—	2,50	7,80	9,30	0,55	2,79	3,60	2,44	12,38	15,97	2,80	6,20	A++
	2,50	7,10	—	—	—	2,57	6,43	—	—	—	2,50	9,00	9,30	0,55	2,99	3,60	2,44	13,27	15,97	3,01	6,20	A++
	3,50	3,50	—	—	—	3,60	3,60	—	—	—	2,50	7,20	9,30	0,55	2,41	3,60	2,44	10,69	15,97	2,99	6,20	A++
	3,50	4,20	—	—	—	3,60	4,40	—	—	—	2,50	8,00	9,30	0,55	2,68	3,60	2,44	11,89	15,97	2,99	6,20	A++
	3,50	5,00	—	—	—	3,60	5,20	—	—	—	2,50	8,80	10,00	0,55	2,91	3,60	2,44	12,91	15,97	3,02	6,20	A++
	3,50	7,10	—	—	—	3,21	5,79	—	—	—	2,50	9,00	11,00	0,55	3,02	3,60	2,44	13,40	15,97	2,98	6,20	A++
	4,20	4,20	—	—	—	4,40	4,40	—	—	—	2,50	8,80	10,00	0,55	2,83	3,60	2,44	12,56	15,97	3,11	6,20	A++
	4,20	5,00	—	—	—	4,13	4,88	—	—	—	2,50	9,00	10,50	0,55	2,89	3,60	2,44	12,82	15,97	3,11	6,20	A++
4,20	7,10	—	—	—	3,63	5,37	—	—	—	2,50	9,00	11,00	0,55	2,96	3,60	2,44	13,13	15,97	3,04	6,20	A++	
5,00	5,00	—	—	—	4,50	4,50	—	—	—	2,50	9,00	11,00	0,55	3,01	3,60	2,44	13,35	15,97	2,99	6,20	A++	
5,00	7,10	—	—	—	4,00	5,00	—	—	—	2,50	9,00	11,00	0,55	3,15	3,60	2,44	13,98	15,97	2,86	6,20	A++	
7,10	7,10	—	—	—	4,50	4,50	—	—	—	2,50	9,00	11,00	0,55	3,15	3,60	2,44	13,98	15,97	2,86	6,20	A++	
3	2,00	2,00	2,00	—	—	2,00	2,00	2,00	—	—	3,00	6,00	9,50	0,55	2,05	3,80	2,44	9,09	16,86	2,93	6,70	A++
	2,00	2,00	2,50	—	—	2,00	2,00	2,60	—	—	3,00	6,60	9,50	0,55	2,21	3,80	2,44	9,80	16,86	2,99	6,70	A++
	2,00	2,00	3,50	—	—	2,00	2,00	3,60	—	—	3,00	7,60	9,50	0,55	2,38	3,80	2,44	10,56	16,86	3,19	6,70	A++
	2,00	2,00	4,20	—	—	2,00	2,00	4,40	—	—	3,20	8,40	9,50	0,55	2,67	3,80	2,44	11,85	16,86	3,15	6,70	A++
	2,00	2,00	5,00	—	—	1,96	1,96	5,09	—	—	3,20	9,00	10,00	0,55	2,84	3,80	2,44	12,60	16,86	3,17	6,70	A++
	2,00	2,00	7,10	—	—	1,71	1,71	5,57	—	—	3,20	9,00	11,00	0,55	2,98	4,10	2,44	13,22	18,19	3,02	6,70	A++
	2,00	2,50	2,50	—	—	2,00	2,60	2,60	—	—	3,20	7,20	9,50	0,55	2,33	3,80	2,44	10,34	16,86	3,09	6,70	A++
	2,00	2,50	3,50	—	—	2,00	2,60	3,60	—	—	3,20	8,20	9,50	0,55	2,57	3,80	2,44	11,40	16,86	3,19	6,70	A++
	2,00	2,50	4,20	—	—	2,00	2,60	4,40	—	—	3,20	9,00	10,00	0,55	2,82	3,80	2,44	12,51	16,86	3,19	6,70	A++
	2,00	2,50	5,00	—	—	1,84	2,39	4,78	—	—	3,20	9,00	11,00	0,55	2,88	3,80	2,44	12,78	16,86	3,13	6,70	A++
	2,00	2,50	7,10	—	—	1,62	2,11	5,27	—	—	3,20	9,00	11,00	0,55	3,03	4,10	2,44	13,44	18,19	2,97	6,70	A++
	2,00	3,50	3,50	—	—	1,96	3,52	3,52	—	—	3,20	9,00	11,00	0,55	2,86	3,80	2,44	12,69	16,86	3,15	6,70	A++
	2,00	3,50	4,20	—	—	1,80	3,24	3,96	—	—	3,20	9,00	11,00	0,55	2,93	4,10	2,44	13,00	18,19	3,07	6,70	A++
	2,00	3,50	5,00	—	—	1,67	3,00	4,33	—	—	3,20	9,00	11,00	0,55	2,99	4,10	2,44	13,27	18,19	3,01	6,70	A++
	2,00	3,50	7,10	—	—	1,49	2,68	4,83	—	—	3,20	9,00	11,00	0,55	3,00	4,10	2,44	13,31	18,19	3,00	6,70	A++
	2,00	4,20	4,20	—	—	1,67	3,67	3,67	—	—	3,20	9,00	11,00	0,55	2,97	4,10	2,44	13,18	18,19	3,03	6,70	A++
	2,00	4,20	5,00	—	—	1,55	3,41	4,03	—	—	3,20	9,00	11,00	0,55	2,97	4,10	2,44	13,18	18,19	3,03	6,70	A++
	2,00	4,20	7,10	—	—	1,40	3,07	4,53	—	—	3,20	9,00	11,00	0,55	3,00	4,10	2,44	13,31	18,19	3,00	6,70	A++
	2,00	5,00	5,00	—	—	1,45	3,77	3,77	—	—	3,20	9,00	11,00	0,55	2,98	4,10	2,44	13,22	18,19	3,02	6,70	A++
	2,50	2,50	2,50	—	—	2,60	2,60	2,60	—	—	3,20	7,80	9,50	0,55	2,56	3,80	2,44	11,36	16,86	3,05	6,72	A++
	2,50	2,50	3,50	—	—	2,60	2,60	3,60	—	—	3,20	8,80	10,00	0,55	2,75	3,80	2,44	12,20	16,86	3,20	6,72	A++
	2,50	2,50	4,20	—	—	2,44	2,44	4,13	—	—	3,20	9,00	11,00	0,55	2,87	3,80	2,44	12,73	16,86	3,14	6,74	A++
	2,50	2,50	5,00	—	—	2,25	2,25	4,50	—	—	3,20	9,00	11,00	0,55	2,97	4,10	2,44	13,18	18,19	3,03	6,74	A++
	2,50	2,50	7,10	—	—	2,00	2,00	5,00	—	—	3,20	9,00	11,00	0,55	2,97	4,10	2,44	13,18	18,19	3,03	6,70	A++
	2,50	3,50	3,50	—	—	2,39	3,31	3,31	—	—	3,20	9,00	11,00	0,55	2,92	3,80	2,44	12,95	16,86	3,08	6,73	A++
	2,50	3,50	4,20	—	—	2,21	3,06	3,74	—	—	3,20	9,00	11,00	0,55	2,97	4,10	2,44	13,18	18,19	3,03	6,70	A++
	2,50	3,50	5,00	—	—	2,05	2,84	4,11	—	—	3,20	9,00	11,00	0,55	2,97	4,10	2,44	13,18	18,19	3,03	6,70	A++
	2,50	3,50	7,10	—	—	1,84	2,55	4,61	—	—	3,20	9,00	11,00	0,55	2,97	4,10	2,44	13,18	18,19	3,03	6,70	A++
	2,50	4,20	4,20	—	—	2,05	3,47	3,47	—	—	3,20	9,00	11,00	0,55	2,97	4,10	2,44	13,18	18,19	3,03	6,70	A++
	2,50	4,20	5,00	—	—	1,92	3,25	3,84	—	—	3,20	9,00	11,00	0,55	2,97	4,10	2,44	13,18	18,19	3,03	6,70	A++
	2,50	4,20	7,10	—	—	1,73	2,93	4,33	—	—	3,20	9,00	11,00	0,55	3,00	4,10	2,44	13,31	18,19	3,00	6,70	A++
	2,50	5,00	5,00	—	—	1,80	3,60	3,60	—	—	3,20	9,00	11,00	0,55	3,00	4,10	2,44	13,31	18,19	3,00	6,70	A++
	3,50	3,50	3,50	—	—	3,00	3,00	3,00	—	—	3,20	9,00	11,00	0,55	2,96	4,10	2,44	13,13	18,19	3,04	6,75	A++
3,50	3,50	4,20	—	—	2,79	2,79	3,41	—	—	3,20	9,00	11,00	0,55	2,95	4,10	2,44	13,09	18,19	3,05	6,70	A++	
3,50	3,50	5,00	—	—	2,61	2,61	3,77	—	—	3,20	9,00	11,00	0,55	2,96	4,10	2,44	13,13	18,19	3,04	6,70	A++	
3,50	3,50	7,10	—	—	2,36	2,36	4,27	—	—	3,20	9,00	11,00	0,55	2,96	4,10	2,44	13,13	18,19	3,04	6,70	A++	
3,50	4,20	4,20	—	—	2,61	3,19	3,19	—	—	3,20	9,00	11,00	0,55	2,96	4,10	2,44	13,13	18,19	3,04	6,75	A++	
3,50	4,20	5,00	—	—	2,45	3,00	3,55	—	—	3,20	9,00	11,00	0,55	2,94	4,10	2,44	13,04	18,19	3,06	6,75	A++	
3,50	5,00	5,00	—	—	2,31	3,34	3,34	—	—	3,20	9,00	11,00	0,55	3,00	4,10	2,44	13,31	18,19	3,00	6,75	A++	
4,20	4,20	4,20	—	—	3,00	3,00	3,00	—	—	3,20	9,00	11,00	0,55	3,00	4,10	2,44	13,31	18,19	3,00	6,75	A++	
4,20	4,20	5,00	—	—	2,83	2,83	3,34	—	—	3,20	9,00	11,00	0,55	3,00	4,10	2,44	13,31	18,19	3,00	6,75	A++	

# COMBINATIONS TABLE

5U90S2SS5FA Inverter (The values in the table refer to the FLEXIS series)

COOLING																						
Combinations					Output power (kW)					System output power (kW)			Absorbed power (kW)			Absorbed current (A)			EER	SEER	Energy class	
UI	A	B	C	D	E	A	B	C	D	E	min	nom	max	min	nom	max	min	nom	max			
4	2,00	2,00	2,00	2,00	—	2,00	2,00	2,00	2,00	—	3,20	8,00	11,00	0,55	2,66	4,00	2,44	11,80	17,75	3,01	6,80	A++
	2,00	2,00	2,00	2,50	—	2,00	2,00	2,00	2,60	—	3,20	8,60	11,00	0,55	2,78	4,00	2,44	12,33	17,75	3,09	6,80	A++
	2,00	2,00	2,00	3,50	—	1,88	1,88	1,88	3,38	—	3,20	9,00	11,00	0,55	2,86	4,00	2,44	12,69	17,75	3,15	6,80	A++
	2,00	2,00	2,00	4,20	—	1,73	1,73	1,73	3,81	—	3,20	9,00	11,00	0,55	2,92	4,10	2,44	12,95	18,19	3,08	6,80	A++
	2,00	2,00	2,00	5,00	—	1,61	1,61	1,61	4,18	—	3,20	9,00	11,00	0,55	2,91	4,10	2,44	12,91	18,19	3,09	6,80	A++
	2,00	2,00	2,00	7,10	—	1,44	1,44	1,44	4,68	—	3,20	9,00	11,00	0,55	2,91	4,10	2,44	12,91	18,19	3,09	6,70	A++
	2,00	2,00	2,50	2,50	—	1,96	1,96	2,54	2,54	—	3,20	9,00	11,00	0,55	2,83	4,00	2,44	12,56	17,75	3,18	6,80	A++
	2,00	2,00	2,50	3,50	—	1,76	1,76	2,29	3,18	—	3,20	9,00	11,00	0,55	2,91	4,10	2,44	12,91	18,19	3,09	6,80	A++
	2,00	2,00	2,50	4,20	—	1,64	1,64	2,13	3,60	—	3,20	9,00	11,00	0,55	2,91	4,10	2,44	12,91	18,19	3,09	6,80	A++
	2,00	2,00	2,50	5,00	—	1,53	1,53	1,98	3,97	—	3,20	9,00	11,00	0,55	2,91	4,10	2,44	12,91	18,19	3,09	6,80	A++
	2,00	2,00	2,50	7,10	—	1,37	1,37	1,79	4,47	—	3,20	9,00	11,00	0,55	2,92	4,10	2,44	12,95	18,19	3,08	6,70	A++
	2,00	2,00	3,50	3,50	—	1,61	1,61	2,89	2,89	—	3,20	9,00	11,00	0,55	2,91	4,10	2,44	12,91	18,19	3,09	6,80	A++
	2,00	2,00	3,50	4,20	—	1,50	1,50	2,70	3,30	—	3,20	9,00	11,00	0,55	2,92	4,10	2,44	12,95	18,19	3,08	6,70	A++
	2,00	2,00	3,50	5,00	—	1,41	1,41	2,53	3,66	—	3,20	9,00	11,00	0,55	2,91	4,10	2,44	12,91	18,19	3,09	6,70	A++
	2,00	2,00	4,20	4,20	—	1,41	1,41	3,09	3,09	—	3,20	9,00	11,00	0,55	2,92	4,10	2,44	12,95	18,19	3,08	6,90	A++
	2,00	2,00	4,20	5,00	—	1,32	1,32	2,91	3,44	—	3,20	9,00	11,00	0,55	2,92	4,10	2,44	12,95	18,19	3,08	6,90	A++
	2,00	2,00	5,00	5,00	—	1,25	1,25	3,25	3,25	—	3,20	9,00	11,00	0,55	2,92	4,10	2,44	12,95	18,19	3,08	6,90	A++
	2,00	2,50	2,50	2,50	—	1,84	2,39	2,39	2,39	—	3,20	9,00	11,00	0,55	2,85	4,00	2,44	12,64	17,75	3,16	6,90	A++
	2,00	2,50	2,50	3,50	—	1,67	2,17	2,17	3,00	—	3,20	9,00	11,00	0,55	2,90	4,10	2,44	12,87	18,19	3,10	6,90	A++
	2,00	2,50	2,50	4,20	—	1,55	2,02	2,02	3,41	—	3,20	9,00	11,00	0,55	2,91	4,10	2,44	12,91	18,19	3,09	6,90	A++
	2,00	2,50	2,50	5,00	—	1,45	1,89	1,89	3,77	—	3,20	9,00	11,00	0,55	2,90	4,10	2,44	12,87	18,19	3,10	6,90	A++
	2,00	2,50	3,50	3,50	—	1,53	1,98	2,75	2,75	—	3,20	9,00	11,00	0,55	2,84	4,10	2,44	12,60	18,19	3,17	6,90	A++
	2,00	2,50	3,50	4,20	—	1,43	1,86	2,57	3,14	—	3,20	9,00	11,00	0,55	2,87	4,10	2,44	12,73	18,19	3,14	6,90	A++
	2,00	2,50	3,50	5,00	—	1,34	1,75	2,42	3,49	—	3,20	9,00	11,00	0,55	2,86	4,10	2,44	12,69	18,19	3,15	6,90	A++
	2,00	2,50	4,20	4,20	—	1,34	1,75	2,96	2,96	—	3,20	9,00	11,00	0,55	2,85	4,10	2,44	12,64	18,19	3,16	6,90	A++
	2,00	2,50	4,20	5,00	—	1,27	1,65	2,79	3,30	—	3,20	9,00	11,00	0,55	2,90	4,10	2,44	12,87	18,19	3,10	6,90	A++
	2,00	3,50	3,50	3,50	—	1,41	2,53	2,53	2,53	—	3,20	9,00	11,00	0,55	2,87	4,10	2,44	12,73	18,19	3,14	6,90	A++
	2,00	3,50	3,50	4,20	—	1,32	2,38	2,38	2,91	—	3,20	9,00	11,00	0,55	2,89	4,10	2,44	12,82	18,19	3,11	6,90	A++
	2,00	3,50	3,50	5,00	—	1,25	2,25	2,25	3,25	—	3,20	9,00	11,00	0,55	2,93	4,10	2,44	13,00	18,19	3,07	6,90	A++
	2,00	3,50	4,20	4,20	—	1,25	2,25	2,75	2,75	—	3,20	9,00	11,00	0,55	2,91	4,10	2,44	12,91	18,19	3,09	6,90	A++
	2,00	4,20	4,20	4,20	—	1,18	2,61	2,61	2,61	—	3,20	9,00	11,00	0,55	2,92	4,10	2,44	12,95	18,19	3,08	6,90	A++
	2,50	2,50	2,50	2,50	—	2,25	2,25	2,25	2,25	—	3,20	9,00	11,00	0,55	2,87	4,10	2,44	12,73	18,19	3,14	6,90	A++
	2,50	2,50	2,50	3,50	—	2,05	2,05	2,05	2,84	—	3,20	9,00	11,00	0,55	2,81	4,10	2,44	12,47	18,19	3,20	6,90	A++
	2,50	2,50	2,50	4,20	—	1,92	1,92	1,92	3,25	—	3,20	9,00	11,00	0,55	2,76	4,10	2,44	12,24	18,19	3,26	6,90	A++
	2,50	2,50	2,50	5,00	—	1,80	1,80	1,80	3,60	—	3,20	9,00	11,00	0,55	2,78	4,10	2,44	12,33	18,19	3,24	6,90	A++
2,50	2,50	3,50	3,50	—	1,89	1,89	2,61	2,61	—	3,20	9,00	11,00	0,55	2,81	4,10	2,44	12,47	18,19	3,20	6,90	A++	
2,50	2,50	3,50	4,20	—	1,77	1,77	2,45	3,00	—	3,20	9,00	11,00	0,55	2,80	4,10	2,44	12,42	18,19	3,21	7,00	A++	
2,50	2,50	3,50	5,00	—	1,67	1,67	2,31	3,34	—	3,20	9,00	11,00	0,55	2,79	4,10	2,44	12,38	18,19	3,23	7,00	A++	
2,50	2,50	4,20	4,20	—	1,67	1,67	2,83	2,83	—	3,20	9,00	11,00	0,55	2,79	4,10	2,44	12,38	18,19	3,23	7,00	A++	
2,50	3,50	3,50	3,50	—	1,75	2,42	2,42	2,42	—	3,20	9,00	11,00	0,55	2,79	4,10	2,44	12,38	18,19	3,23	7,00	A++	
2,50	3,50	3,50	4,20	—	1,65	2,28	2,28	2,79	—	3,20	9,00	11,00	0,55	2,79	4,10	2,44	12,38	18,19	3,23	7,00	A++	
3,50	3,50	3,50	3,50	—	2,25	2,25	2,25	2,25	—	3,20	9,00	11,00	0,55	2,79	4,10	2,44	12,38	18,19	3,23	7,00	A++	
5	2,00	2,00	2,00	2,00	2,00	1,80	1,80	1,80	1,80	1,80	3,20	9,00	11,00	0,55	2,79	4,10	2,44	12,38	18,19	3,23	7,00	A++
	2,00	2,00	2,00	2,00	2,50	1,70	1,70	1,70	1,70	2,21	3,20	9,00	11,00	0,55	2,79	4,10	2,44	12,38	18,19	3,23	7,00	A++
	2,00	2,00	2,00	2,00	3,50	1,55	1,55	1,55	1,55	2,79	3,20	9,00	11,00	0,55	2,79	4,10	2,44	12,38	18,19	3,23	7,00	A++
	2,00	2,00	2,00	2,00	4,20	1,45	1,45	1,45	1,45	3,19	3,20	9,00	11,00	0,55	2,79	4,10	2,44	12,38	18,19	3,23	7,00	A++
	2,00	2,00	2,00	2,00	5,00	1,36	1,36	1,36	1,36	3,55	3,20	9,00	11,00	0,55	2,79	4,10	2,44	12,38	18,19	3,23	7,00	A++
	2,00	2,00	2,00	2,50	2,50	1,61	1,61	1,61	2,09	2,09	3,20	9,00	11,00	0,55	2,79	4,10	2,44	12,38	18,19	3,23	7,00	A++
	2,00	2,00	2,00	2,50	3,50	1,48	1,48	1,48	1,92	2,66	3,20	9,00	11,00	0,55	2,79	4,10	2,44	12,38	18,19	3,23	7,00	A++
	2,00	2,00	2,00	2,50	4,20	1,38	1,38	1,38	1,80	3,05	3,20	9,00	11,00	0,55	2,79	4,10	2,44	12,38	18,19	3,23	7,00	A++
	2,00	2,00	2,00	2,50	5,00	1,30	1,30	1,30	1,70	3,39	3,20	9,00	11,00	0,55	2,79	4,10	2,44	12,38	18,19	3,23	7,00	A++
	2,00	2,00	2,00	3,50	3,50	1,36	1,36	1,36	2,45	2,45	3,20	9,00	11,00	0,55	2,79	4,10	2,44	12,38	18,19	3,23	7,00	A++
	2,00	2,00	2,00	3,50	4,20	1,29	1,29	1,29	2,31	2,83	3,20	9,00	11,00	0,55	2,79	4,10	2,44	12,38	18,19	3,23	7,00	A++
	2,00	2,00	2,50	2,50	2,50	1,53	1,53	1,98	1,98	1,98	3,20	9,00	11,00	0,55	2,79	4,10	2,44	12,38	18,19	3,23	7,00	A++
	2,00	2,00	2,50	2,50	3,50	1,41	1,41	1,83	1,83	2,53	3,20	9,00	11,00	0,55	2,79	4,10	2,44	12,38	18,19	3,23	7,00	A++
	2,00	2,00	2,50	2,50	4,20	1,32	1,32	1,72	1,72	2,91	3,20	9,00	11,00	0,55	2,79	4,10	2,44	12,38	18,19	3,23	7,00	A++
	2,00	2,00	2,50	2,50	5,00	1,25	1,25	1,63	1,63	3,25	3,20	9,00	11,00	0,55	2,79	4,10	2,44	12,38	18,19	3,23	7,00	A++
	2,00	2,00	2,50	3,50	3,50	1,30	1,30	1,70	2,35	2,35	3,20	9,00	11,00	0,55	2,79	4,10	2,44	12,38	18,19	3,23	7,00	A++
	2,00	2,50	2,50	2,50	2,50	1,45	1,89	1,89	1,89	1,89	3,20	9,00	11,00	0,55	2,79	4,10	2,44	12,38	18,19	3,23	7,00	A++
	2,00	2,50	2,50	2,50	3,50	1,34	1,75	1,75	1,75	2,42	3,20	9,00	11,00	0,55	2,79	4,10						

5U90S2SS5FA Inverter (The values in the table refer to the FLEXIS series)

HEATING																						
Combinations					Output power (kW)					System output power (kW)			Absorbed power (kW)			Absorbed current (A)			COP	SCOP	Energy class	
UI	A	B	C	D	E	A	B	C	D	E	min	nom	max	min	nom	max	min	nom	max			
2	2,00	2,00	—	—	—	2,30	2,30	—	—	—	2,80	4,60	8,00	0,55	1,30	3,30	2,44	5,77	14,64	3,54	3,75	A
	2,00	2,50	—	—	—	2,30	3,60	—	—	—	3,00	5,90	10,00	0,55	1,66	3,30	2,44	7,36	14,64	3,55	3,75	A
	2,00	3,50	—	—	—	2,30	4,50	—	—	—	3,20	6,80	10,00	0,55	1,90	3,30	2,44	8,43	14,64	3,58	3,75	A
	2,00	4,20	—	—	—	2,30	5,40	—	—	—	3,40	7,70	10,00	0,55	2,15	3,30	2,44	9,54	14,64	3,58	3,80	A
	2,00	5,00	—	—	—	2,30	6,00	—	—	—	3,80	8,30	11,50	0,55	2,29	3,30	2,44	10,16	14,64	3,62	3,80	A
	2,00	7,10	—	—	—	2,30	7,00	—	—	—	4,00	9,30	11,50	0,55	2,55	3,30	2,44	11,31	14,64	3,65	3,85	A
	2,50	2,50	—	—	—	3,60	3,60	—	—	—	3,40	7,20	10,50	0,55	2,02	3,30	2,44	8,96	14,64	3,56	3,85	A
	2,50	3,50	—	—	—	3,60	4,50	—	—	—	3,80	8,10	10,50	0,55	2,26	3,30	2,44	10,03	14,64	3,58	3,83	A
	2,50	4,20	—	—	—	3,60	5,40	—	—	—	4,00	9,00	10,50	0,55	2,50	3,30	2,44	11,09	14,64	3,60	3,87	A
	2,50	5,00	—	—	—	3,60	6,00	—	—	—	4,40	9,60	10,50	0,55	2,64	3,30	2,44	11,71	14,64	3,64	3,85	A
	2,50	7,10	—	—	—	3,53	6,87	—	—	—	4,40	10,40	11,00	0,55	2,85	3,30	2,44	12,64	14,64	3,65	3,84	A
	3,50	3,50	—	—	—	4,50	4,50	—	—	—	4,00	9,00	10,50	0,55	2,50	3,30	2,44	11,09	14,64	3,60	3,86	A
	3,50	4,20	—	—	—	4,50	5,40	—	—	—	4,40	9,90	10,50	0,55	2,74	3,30	2,44	12,16	14,64	3,61	3,82	A
	3,50	5,00	—	—	—	4,46	5,94	—	—	—	4,40	10,40	11,50	0,55	2,88	3,30	2,44	12,78	14,64	3,61	3,80	A
	3,50	7,10	—	—	—	4,07	6,33	—	—	—	4,40	10,40	11,50	0,55	2,88	3,30	2,44	12,78	14,64	3,61	3,84	A
	4,20	4,20	—	—	—	5,20	5,20	—	—	—	4,40	10,40	11,50	0,55	2,88	3,30	2,44	12,78	14,64	3,61	3,86	A
	4,20	5,00	—	—	—	4,93	5,47	—	—	—	4,40	10,40	11,50	0,55	2,88	3,30	2,44	12,78	14,64	3,61	3,83	A
4,20	7,10	—	—	—	4,53	5,87	—	—	—	4,40	10,40	11,50	0,55	2,88	3,30	2,44	12,78	14,64	3,61	3,86	A	
5,00	5,00	—	—	—	5,20	5,20	—	—	—	4,40	10,40	11,50	0,55	2,88	3,30	2,44	12,78	14,64	3,61	3,80	A	
5,00	7,10	—	—	—	4,80	5,60	—	—	—	4,40	10,40	11,50	0,55	2,88	3,30	2,44	12,78	14,64	3,61	3,87	A	
7,10	7,10	—	—	—	5,20	5,20	—	—	—	4,40	10,40	11,50	0,55	2,88	3,30	2,44	12,78	14,64	3,61	3,87	A	
3	2,00	2,00	2,00	—	—	2,30	2,30	2,30	—	—	3,80	6,90	11,50	0,55	1,93	3,40	2,44	8,56	15,08	3,58	3,80	A
	2,00	2,00	2,50	—	—	2,30	2,30	3,60	—	—	4,00	8,20	11,50	0,55	2,28	3,40	2,44	10,12	15,08	3,60	3,80	A
	2,00	2,00	3,50	—	—	2,30	2,30	4,50	—	—	4,20	9,10	11,50	0,55	2,50	3,40	2,44	11,09	15,08	3,64	3,80	A
	2,00	2,00	4,20	—	—	2,30	2,30	5,40	—	—	4,40	10,00	11,50	0,55	2,73	3,40	2,44	12,11	15,08	3,66	3,80	A
	2,00	2,00	5,00	—	—	2,26	2,26	5,89	—	—	4,40	10,40	11,50	0,55	2,88	3,40	2,44	12,78	15,08	3,61	3,80	A
	2,00	2,00	7,10	—	—	2,06	2,06	6,28	—	—	4,40	10,40	11,50	0,55	2,88	3,40	2,44	12,78	15,08	3,61	3,80	A
	2,00	2,50	2,50	—	—	2,30	3,60	3,60	—	—	4,40	9,50	11,50	0,55	2,63	3,40	2,44	11,67	15,08	3,61	3,80	A
	2,00	2,50	3,50	—	—	2,30	3,60	4,50	—	—	4,40	10,40	11,50	0,55	2,88	3,40	2,44	12,78	15,08	3,61	3,80	A
	2,00	2,50	4,20	—	—	2,12	3,31	4,97	—	—	4,40	10,40	11,50	0,55	2,88	3,40	2,44	12,78	15,08	3,61	3,80	A
	2,00	2,50	5,00	—	—	2,01	3,15	5,24	—	—	4,40	10,40	11,50	0,55	2,88	3,40	2,44	12,78	15,08	3,61	3,82	A
	2,00	2,50	7,10	—	—	1,85	2,90	5,64	—	—	4,40	10,40	11,50	0,55	2,88	3,40	2,44	12,78	15,08	3,61	3,82	A
	2,00	3,50	3,50	—	—	2,12	4,14	4,14	—	—	4,40	10,40	11,50	0,55	2,88	3,40	2,44	12,78	15,08	3,61	3,82	A
	2,00	3,50	4,20	—	—	1,96	3,84	4,60	—	—	4,40	10,40	11,50	0,55	2,88	3,40	2,44	12,78	15,08	3,61	3,82	A
	2,00	3,50	5,00	—	—	1,87	3,66	4,88	—	—	4,40	10,40	11,50	0,55	2,88	3,40	2,44	12,78	15,08	3,61	3,82	A
	2,00	3,50	7,10	—	—	1,73	3,39	5,28	—	—	4,40	10,40	11,50	0,55	2,86	3,40	2,44	12,69	15,08	3,64	3,82	A
	2,00	4,20	4,20	—	—	1,83	4,29	4,29	—	—	4,40	10,40	11,50	0,55	2,86	3,40	2,44	12,69	15,08	3,64	3,82	A
	2,00	4,20	5,00	—	—	1,75	4,10	4,55	—	—	4,40	10,40	11,50	0,55	2,86	3,40	2,44	12,69	15,08	3,64	3,82	A
	2,00	4,20	7,10	—	—	1,63	3,82	4,95	—	—	4,40	10,40	11,50	0,55	2,86	3,40	2,44	12,69	15,08	3,64	3,87	A
	2,00	5,00	5,00	—	—	1,67	4,36	4,36	—	—	4,40	10,40	11,50	0,55	2,86	3,40	2,44	12,69	15,08	3,64	3,87	A
	2,50	2,50	2,50	—	—	3,47	3,47	3,47	—	—	4,40	10,40	11,50	0,55	2,85	3,40	2,44	12,64	15,08	3,65	3,87	A
	2,50	2,50	3,50	—	—	3,20	3,20	4,00	—	—	4,40	10,40	11,50	0,55	2,85	3,40	2,44	12,64	15,08	3,65	3,87	A
	2,50	2,50	4,20	—	—	2,97	2,97	4,46	—	—	4,40	10,40	11,50	0,55	2,85	3,40	2,44	12,64	15,08	3,65	3,87	A
	2,50	2,50	5,00	—	—	2,84	2,84	4,73	—	—	4,40	10,40	11,50	0,55	2,85	3,40	2,44	12,64	15,08	3,65	3,87	A
	2,50	2,50	7,10	—	—	2,64	2,64	5,13	—	—	4,40	10,40	11,50	0,55	2,85	3,40	2,44	12,64	15,08	3,65	3,90	A
	2,50	3,50	3,50	—	—	2,97	3,71	3,71	—	—	4,40	10,40	11,50	0,55	2,85	3,40	2,44	12,64	15,08	3,65	3,85	A
	2,50	3,50	4,20	—	—	2,77	3,47	4,16	—	—	4,40	10,40	11,50	0,55	2,85	3,40	2,44	12,64	15,08	3,65	3,85	A
	2,50	3,50	5,00	—	—	2,66	3,32	4,43	—	—	4,40	10,40	11,50	0,55	2,85	3,40	2,44	12,64	15,08	3,65	3,85	A
	2,50	3,50	7,10	—	—	2,48	3,10	4,82	—	—	4,40	10,40	11,50	0,55	2,85	3,40	2,44	12,64	15,08	3,65	3,85	A
	2,50	4,20	4,20	—	—	2,60	3,90	3,90	—	—	4,40	10,40	11,50	0,55	2,85	3,40	2,44	12,64	15,08	3,65	3,85	A
	2,50	4,20	5,00	—	—	2,50	3,74	4,16	—	—	4,40	10,40	11,50	0,55	2,85	3,40	2,44	12,64	15,08	3,65	3,85	A
	2,50	4,20	7,10	—	—	2,34	3,51	4,55	—	—	4,40	10,40	11,50	0,55	2,85	3,40	2,44	12,64	15,08	3,65	3,85	A
	2,50	5,00	5,00	—	—	2,40	4,00	4,00	—	—	4,40	10,40	11,50	0,55	2,85	3,40	2,44	12,64	15,08	3,65	3,85	A
	3,50	3,50	3,50	—	—	3,47	3,47	3,47	—	—	4,40	10,40	11,50	0,55	2,85	3,40	2,44	12,64	15,08	3,65	3,90	A
3,50	3,50	4,20	—	—	3,25	3,25	3,90	—	—	4,40	10,40	11,50	0,55	2,85	3,40	2,44	12,64	15,08	3,65	3,90	A	
3,50	3,50	5,00	—	—	3,12	3,12	4,16	—	—	4,40	10,40	11,50	0,55	2,83	3,40	2,44	12,56	15,08	3,67	3,90	A	
3,50	3,50	7,10	—	—	2,93	2,93	4,55	—	—	4,40	10,40	11,50	0,55	2,83	3,40	2,44	12,56	15,08	3,67	3,90	A	
3,50	4,20	4,20	—	—	3,06	3,67	3,67	—	—	4,40	10,40	11,50	0,55	2,83	3,40	2,44	12,56	15,08	3,67	3,90	A	
3,50	4,20	5,00	—	—	2,94	3,53	3,92	—	—	4,40	10,40	11,50	0,55	2,83	3,40	2,44	12,56	15,08	3,67	3,90	A	
3,50	5,00	5,00	—	—	2,84	3,78	3,78	—	—	4,40	10,40	11,50	0,55	2,83	3,40	2,44	12,56	15,08	3,67	3,90	A	
4,20	4,20	4,20	—	—	3,47	3,47	3,47	—	—	4,40	10,40	11,50	0,55	2,83	3,40	2,44	12,56	15,08	3,67	3,90	A	
4,20	4,20	5,00	—	—	3,34	3,34	3,71	—	—	4,40	10,40	11,50	0,55	2,83	3,40	2,44	12,56	15,08	3,67	3,90	A	

# COMBINATIONS TABLE

5U90S2SS5FA Inverter (The values in the table refer to the FLEXIS series)

HEATING																							
Combinations					Output power (kW)					System output power (kW)			Absorbed power (kW)			Absorbed current (A)			COP	SCOP	Energy class		
UI	A	B	C	D	E	A	B	C	D	E	min	nom	max	min	nom	max	min	nom	max				
4	2,00	2,00	2,00	2,00	—	2,30	2,30	2,30	2,30	—	4,20	9,20	11,50	0,55	2,55	3,40	2,44	11,31	15,08	3,61	3,85	A	
	2,00	2,00	2,00	2,50	—	2,28	2,28	2,28	3,57	—	4,20	10,40	11,50	0,55	2,84	3,40	2,44	12,60	15,08	3,66	3,85	A	
	2,00	2,00	2,00	3,50	—	2,10	2,10	2,10	4,11	—	4,40	10,40	11,50	0,55	2,84	3,40	2,44	12,60	15,08	3,66	3,85	A	
	2,00	2,00	2,00	4,20	—	1,94	1,94	1,94	4,57	—	4,40	10,40	11,50	0,55	2,84	3,40	2,44	12,60	15,08	3,66	3,85	A	
	2,00	2,00	2,00	5,00	—	1,85	1,85	1,85	4,84	—	4,40	10,40	11,50	0,55	2,84	3,40	2,44	12,60	15,08	3,66	3,85	A	
	2,00	2,00	2,00	7,10	—	1,72	1,72	1,72	5,24	—	4,40	10,40	11,50	0,55	2,84	3,40	2,44	12,60	15,08	3,66	3,85	A	
	2,00	2,00	2,50	2,50	—	2,03	2,03	3,17	3,17	—	4,40	10,40	11,50	0,55	2,84	3,40	2,44	12,60	15,08	3,66	3,85	A	
	2,00	2,00	2,50	3,50	—	1,88	1,88	2,95	3,69	—	4,40	10,40	11,50	0,55	2,83	3,40	2,44	12,56	15,08	3,67	3,85	A	
	2,00	2,00	2,50	4,20	—	1,76	1,76	2,75	4,13	—	4,40	10,40	11,50	0,55	2,83	3,40	2,44	12,56	15,08	3,67	3,90	A	
	2,00	2,00	2,50	5,00	—	1,68	1,68	2,64	4,39	—	4,40	10,40	11,50	0,55	2,83	3,40	2,44	12,56	15,08	3,67	3,90	A	
	2,00	2,00	2,50	7,10	—	1,57	1,57	2,46	4,79	—	4,40	10,40	11,50	0,55	2,83	3,40	2,44	12,56	15,08	3,67	3,90	A	
	2,00	2,00	3,50	3,50	—	1,76	1,76	3,44	3,44	—	4,40	10,40	11,50	0,55	2,83	3,40	2,44	12,56	15,08	3,67	3,90	A	
	2,00	2,00	3,50	4,20	—	1,65	1,65	3,23	3,87	—	4,40	10,40	11,50	0,55	2,83	3,40	2,44	12,56	15,08	3,67	3,90	A	
	2,00	2,00	3,50	5,00	—	1,58	1,58	3,10	4,13	—	4,40	10,40	11,50	0,55	2,81	3,40	2,44	12,47	15,08	3,70	3,90	A	
	2,00	2,00	4,20	4,20	—	1,55	1,55	3,65	3,65	—	4,40	10,40	11,50	0,55	2,81	3,40	2,44	12,47	15,08	3,70	3,90	A	
	2,00	2,00	4,20	5,00	—	1,50	1,50	3,51	3,90	—	4,40	10,40	11,50	0,55	2,81	3,40	2,44	12,47	15,08	3,70	3,90	A	
	2,00	2,00	5,00	5,00	—	1,44	1,44	3,76	3,76	—	4,40	10,40	11,50	0,55	2,81	3,40	2,44	12,47	15,08	3,70	3,90	A	
	2,00	2,50	2,50	2,50	—	1,83	2,86	2,86	2,86	—	4,40	10,40	11,50	0,55	2,81	3,40	2,44	12,47	15,08	3,70	3,90	A	
	2,00	2,50	2,50	3,50	—	1,71	2,67	2,67	3,34	—	4,40	10,40	11,50	0,55	2,81	3,40	2,44	12,47	15,08	3,70	3,90	A	
	2,00	2,50	2,50	4,20	—	1,61	2,51	2,51	3,77	—	4,40	10,40	11,50	0,55	2,81	3,40	2,44	12,47	15,08	3,70	3,95	A	
	2,00	2,50	2,50	5,00	—	1,54	2,42	2,42	4,03	—	4,40	10,40	11,50	0,55	2,83	3,40	2,44	12,56	15,08	3,67	3,95	A	
	2,00	2,50	3,50	3,50	—	1,61	2,51	3,14	3,14	—	4,40	10,40	11,50	0,55	2,80	3,40	2,44	12,42	15,08	3,71	3,95	A	
	2,00	2,50	3,50	4,20	—	1,51	2,37	2,96	3,55	—	4,40	10,40	11,50	0,55	2,81	3,40	2,44	12,47	15,08	3,70	3,95	A	
	2,00	2,50	3,50	5,00	—	1,46	2,28	2,85	3,80	—	4,40	10,40	11,50	0,55	2,83	3,40	2,44	12,56	15,08	3,67	3,95	A	
	2,00	2,50	4,20	4,20	—	1,43	2,24	3,36	3,36	—	4,40	10,40	11,50	0,55	2,81	3,40	2,44	12,47	15,08	3,70	3,95	A	
	2,00	2,50	4,20	5,00	—	1,38	2,16	3,25	3,61	—	4,40	10,40	11,50	0,55	2,82	3,40	2,44	12,51	15,08	3,69	3,95	A	
	2,00	3,50	3,50	3,50	—	1,51	2,96	2,96	2,96	—	4,40	10,40	11,50	0,55	2,80	3,40	2,44	12,42	15,08	3,71	3,95	A	
	2,00	3,50	3,50	4,20	—	1,43	2,80	2,80	3,36	—	4,40	10,40	11,50	0,55	2,80	3,40	2,44	12,42	15,08	3,71	4,00	A+	
	2,00	3,50	3,50	5,00	—	1,38	2,71	2,71	3,61	—	4,40	10,40	11,50	0,55	2,83	3,40	2,44	12,56	15,08	3,67	4,00	A+	
	2,00	3,50	4,20	4,20	—	1,36	2,66	3,19	3,19	—	4,40	10,40	11,50	0,55	2,82	3,40	2,44	12,51	15,08	3,69	4,00	A+	
	2,00	4,20	4,20	4,20	—	1,29	3,04	3,04	3,04	—	4,40	10,40	11,50	0,55	2,81	3,40	2,44	12,47	15,08	3,70	4,00	A+	
	2,50	2,50	2,50	2,50	—	2,60	2,60	2,60	2,60	—	4,40	10,40	11,50	0,55	2,76	3,40	2,44	12,24	15,08	3,77	4,00	A+	
2,50	2,50	2,50	3,50	—	2,45	2,45	2,45	3,06	—	4,40	10,40	11,50	0,55	2,80	3,40	2,44	12,42	15,08	3,71	4,00	A+		
2,50	2,50	2,50	4,20	—	2,31	2,31	2,31	3,47	—	4,40	10,40	11,50	0,55	2,80	3,40	2,44	12,42	15,08	3,71	4,00	A+		
2,50	2,50	2,50	5,00	—	2,23	2,23	2,23	3,71	—	4,40	10,40	11,50	0,55	2,81	3,40	2,44	12,47	15,08	3,70	4,00	A+		
2,50	2,50	3,50	3,50	—	2,31	2,31	2,89	2,89	—	4,40	10,40	11,50	0,55	2,79	3,40	2,44	12,38	15,08	3,73	4,00	A+		
2,50	2,50	3,50	4,20	—	2,19	2,19	2,74	3,28	—	4,40	10,40	11,50	0,55	2,79	3,40	2,44	12,38	15,08	3,73	4,00	A+		
2,50	2,50	3,50	5,00	—	2,12	2,12	2,64	3,53	—	4,40	10,40	11,50	0,55	2,79	3,40	2,44	12,38	15,08	3,73	4,00	A+		
2,50	2,50	4,20	4,20	—	2,08	2,08	3,12	3,12	—	4,40	10,40	11,50	0,55	2,79	3,40	2,44	12,38	15,08	3,73	4,00	A+		
2,50	3,50	3,50	3,50	—	2,19	2,74	2,74	2,74	—	4,40	10,40	11,50	0,55	2,79	3,40	2,44	12,38	15,08	3,73	4,00	A+		
2,50	3,50	3,50	4,20	—	2,08	2,60	2,60	3,12	—	4,40	10,40	11,50	0,55	2,79	3,40	2,44	12,38	15,08	3,73	4,00	A+		
3,50	3,50	3,50	3,50	—	2,60	2,60	2,60	2,60	—	4,40	10,40	11,50	0,55	2,79	3,40	2,44	12,38	15,08	3,73	4,00	A+		
5	2,00	2,00	2,00	2,00	2,00	2,08	2,08	2,08	2,08	2,08	4,20	10,40	11,50	0,55	2,79	3,40	2,44	12,38	15,08	3,73	4,00	A+	
	2,00	2,00	2,00	2,00	2,50	1,87	1,87	1,87	1,87	2,93	4,20	10,40	11,50	0,55	2,79	3,40	2,44	12,38	15,08	3,73	4,00	A+	
	2,00	2,00	2,00	2,00	3,50	1,75	1,75	1,75	1,75	3,42	4,20	10,40	11,50	0,55	2,79	3,40	2,44	12,38	15,08	3,73	4,00	A+	
	2,00	2,00	2,00	2,00	4,20	1,64	1,64	1,64	1,64	3,85	4,20	10,40	11,50	0,55	2,79	3,40	2,44	12,38	15,08	3,73	4,00	A+	
	2,00	2,00	2,00	2,00	5,00	1,57	1,57	1,57	1,57	4,11	4,20	10,40	11,50	0,55	2,79	3,40	2,44	12,38	15,08	3,73	4,00	A+	
	2,00	2,00	2,00	2,50	2,50	1,70	1,70	1,70	2,66	2,66	4,20	10,40	11,50	0,55	2,79	3,40	2,44	12,38	15,08	3,73	4,00	A+	
	2,00	2,00	2,00	2,50	3,50	1,59	1,59	1,59	2,50	3,12	4,20	10,40	11,50	0,55	2,79	3,40	2,44	12,38	15,08	3,73	4,00	A+	
	2,00	2,00	2,00	2,50	4,20	1,50	1,50	1,50	2,35	3,53	4,20	10,40	11,50	0,55	2,79	3,40	2,44	12,38	15,08	3,73	4,00	A+	
	2,00	2,00	2,00	2,50	5,00	1,45	1,45	1,45	2,27	3,78	4,20	10,40	11,50	0,55	2,79	3,40	2,44	12,38	15,08	3,73	4,00	A+	
	2,00	2,00	2,00	3,50	3,50	1,50	1,50	1,50	2,94	2,94	4,40	10,40	11,50	0,55	2,79	3,40	2,44	12,38	15,08	3,73	4,00	A+	
	2,00	2,00	2,00	3,50	4,20	1,42	1,42	1,42	2,79	3,34	4,40	10,40	11,50	0,55	2,79	3,40	2,44	12,38	15,08	3,73	4,00	A+	
	2,00	2,00	2,50	2,50	2,50	1,55	1,55	2,43	2,43	2,43	4,40	10,40	11,50	0,55	2,79	3,40	2,44	12,38	15,08	3,73	4,00	A+	
	2,00	2,00	2,50	2,50	3,50	1,47	1,47	2,30	2,30	2,87	4,40	10,40	11,50	0,55	2,79	3,40	2,44	12,38	15,08	3,73	4,00	A+	
	2,00	2,00	2,50	2,50	4,20	1,39	1,39	2,18	2,18	3,27	4,40	10,40	11,50	0,55	2,79	3,40	2,44	12,38	15,08	3,73	4,00	A+	
	2,00	2,00	2,50	2,50	5,00	1,34	1,34	2,10	2,10	3,51	4,40	10,40	11,50	0,55	2,79	3,40	2,44	12,38	15,08	3,73	4,00	A+	
	2,00	2,00	2,50	3,50	3,50	1,39	1,39	2,18	2,72	2,72	4,40	10,40	11,50	0,55	2,79	3,40	2,44	12,38	15,08	3,73	4,00	A+	
	2,00	2,50	2,50	2,50	2,50	1,43	2,24	2,24	2,24	2,24	4,40	10,40	11,50	0,55	2,79	3,40	2,44	12,38	15,08	3,73	4,00	A+	
	2,00	2,50	2,50	2,50	3,50	1,36	2,13	2,13	2,13	2,66	4,40	10,40	11,50	0,55	2,79	3,40							

## 5U105S2SS5FA Inverter (The values in the table refer to the FLEXIS series)

COOLING																						
Combinations					Output power (kW)					System output power (kW)		Absorbed power (kW)			Absorbed current (A)			EER	SEER	Energy class		
UI	A	B	C	D	E	A	B	C	D	E	min	nom	max	min	nom	max	min	nom	max			
2	2,00	2,00	—	—	—	2,00	2,00	—	—	—	2,50	4,00	5,60	0,55	1,50	3,60	2,44	6,65	15,97	—	—	—
	2,00	2,50	—	—	—	2,00	2,60	—	—	—	2,50	4,60	6,70	0,55	1,67	3,60	2,44	7,41	15,97	2,75	6,20	A++
	2,00	3,50	—	—	—	2,00	3,60	—	—	—	2,50	5,60	8,10	0,55	2,03	3,60	2,44	9,01	15,97	2,76	6,20	A++
	2,00	4,20	—	—	—	2,00	4,40	—	—	—	2,50	6,40	7,80	0,55	2,30	3,60	2,44	10,20	15,97	2,78	6,20	A++
	2,00	5,00	—	—	—	2,00	5,20	—	—	—	2,50	7,20	9,30	0,55	2,58	3,60	2,44	11,45	15,97	2,79	6,20	A++
	2,00	7,10	—	—	—	2,00	6,50	—	—	—	2,50	8,50	9,30	0,55	3,02	3,60	2,44	13,40	15,97	2,81	6,20	A++
	2,50	2,50	—	—	—	2,60	2,60	—	—	—	2,50	5,20	7,80	0,55	1,90	3,60	2,44	8,43	15,97	2,74	6,20	A++
	2,50	3,50	—	—	—	2,60	3,60	—	—	—	2,50	6,20	9,10	0,55	2,24	3,60	2,44	9,94	15,97	2,77	6,20	A++
	2,50	4,20	—	—	—	2,60	4,40	—	—	—	2,50	7,00	9,30	0,55	2,52	3,60	2,44	11,18	15,97	2,78	6,20	A++
	2,50	5,00	—	—	—	2,60	5,20	—	—	—	2,50	7,80	9,30	0,55	2,79	3,60	2,44	12,38	15,97	2,80	6,20	A++
	2,50	7,10	—	—	—	2,60	6,50	—	—	—	2,50	9,10	9,30	0,55	3,17	3,60	2,44	14,06	15,97	2,87	6,20	A++
	3,50	3,50	—	—	—	3,60	3,60	—	—	—	2,50	7,20	9,30	0,55	2,58	3,60	2,44	11,45	15,97	2,79	6,20	A++
	3,50	4,20	—	—	—	3,60	4,40	—	—	—	2,50	8,00	9,30	0,55	2,85	3,60	2,44	12,64	15,97	2,81	6,20	A++
	3,50	5,00	—	—	—	3,60	5,20	—	—	—	2,50	8,80	10,00	0,55	3,10	3,60	2,44	13,75	15,97	2,84	6,20	A++
	3,50	7,10	—	—	—	3,56	6,44	—	—	—	2,50	10,00	11,00	0,55	3,48	3,60	2,44	15,44	15,97	2,87	6,20	A++
	4,20	4,20	—	—	—	4,40	4,40	—	—	—	2,50	8,80	10,00	0,55	3,09	3,60	2,44	13,71	15,97	2,85	6,20	A++
	4,20	5,00	—	—	—	4,40	5,20	—	—	—	2,50	9,60	10,50	0,55	3,38	3,60	2,44	15,00	15,97	2,84	6,20	A++
	4,20	7,10	—	—	—	4,04	5,96	—	—	—	2,50	10,00	11,00	0,55	3,47	3,60	2,44	15,39	15,97	2,88	6,20	A++
5,00	5,00	—	—	—	5,00	5,00	—	—	—	2,50	10,00	11,00	0,55	3,50	3,60	2,44	15,53	15,97	2,86	6,20	A++	
5,00	7,10	—	—	—	4,44	5,56	—	—	—	2,50	9,00	11,00	0,55	3,50	3,60	2,44	15,53	15,97	2,57	6,20	A++	
7,10	7,10	—	—	—	5,00	5,00	—	—	—	2,50	10,00	11,00	0,55	3,45	3,60	2,44	15,31	15,97	2,90	6,20	A++	
3	2,00	2,00	2,00	—	—	2,00	2,00	2,00	—	—	3,00	6,00	9,50	0,55	2,20	3,80	2,44	9,76	16,86	2,73	6,70	A++
	2,00	2,00	2,50	—	—	2,00	2,00	2,60	—	—	3,00	6,60	9,50	0,55	2,40	3,80	2,44	10,65	16,86	2,75	6,70	A++
	2,00	2,00	3,50	—	—	2,00	2,00	3,60	—	—	3,00	7,60	9,50	0,55	2,75	3,80	2,44	12,20	16,86	2,76	6,70	A++
	2,00	2,00	4,20	—	—	2,00	2,00	4,40	—	—	3,20	8,40	9,50	0,55	3,00	3,80	2,44	13,31	16,86	2,80	6,70	A++
	2,00	2,00	5,00	—	—	2,00	2,00	5,20	—	—	3,20	9,20	10,00	0,55	3,20	3,80	2,44	14,20	16,86	2,88	6,70	A++
	2,00	2,00	7,10	—	—	1,90	1,90	6,19	—	—	3,20	10,00	11,00	0,55	3,45	4,10	2,44	15,31	18,19	2,90	6,70	A++
	2,00	2,50	2,50	—	—	2,00	2,60	2,60	—	—	3,20	7,20	9,50	0,55	2,60	3,80	2,44	11,54	16,86	2,77	6,70	A++
	2,00	2,50	3,50	—	—	2,00	2,60	3,60	—	—	3,20	8,20	9,50	0,55	2,93	3,80	2,44	13,00	16,86	2,80	6,70	A++
	2,00	2,50	4,20	—	—	2,00	2,60	4,40	—	—	3,20	9,00	10,00	0,55	3,20	3,80	2,44	14,20	16,86	2,81	6,70	A++
	2,00	2,50	5,00	—	—	2,00	2,60	5,20	—	—	3,20	9,80	11,00	0,55	3,44	3,80	2,44	15,26	16,86	2,85	6,70	A++
	2,00	2,50	7,10	—	—	1,80	2,34	5,86	—	—	3,20	10,00	11,00	0,55	3,50	4,10	2,44	15,53	18,19	2,86	6,70	A++
	2,00	3,50	3,50	—	—	2,00	3,60	3,60	—	—	3,20	9,20	11,00	0,55	3,38	3,80	2,44	15,00	16,86	2,72	6,70	A++
	2,00	3,50	4,20	—	—	2,00	3,60	4,40	—	—	3,20	10,00	11,00	0,55	3,50	4,10	2,44	15,53	18,19	2,86	6,70	A++
	2,00	3,50	5,00	—	—	1,85	3,33	4,81	—	—	3,20	10,00	11,00	0,55	3,50	4,10	2,44	15,53	18,19	2,86	6,70	A++
	2,00	3,50	7,10	—	—	1,65	2,98	5,37	—	—	3,20	10,00	11,00	0,55	3,50	4,10	2,44	15,53	18,19	2,86	6,70	A++
	2,00	4,20	4,20	—	—	1,85	4,07	4,07	—	—	3,20	10,00	11,00	0,55	3,50	4,10	2,44	15,53	18,19	2,86	6,70	A++
	2,00	4,20	5,00	—	—	1,72	3,79	4,48	—	—	3,20	10,00	11,00	0,55	3,50	4,10	2,44	15,53	18,19	2,86	6,70	A++
	2,00	4,20	7,10	—	—	1,55	3,41	5,04	—	—	3,20	10,00	11,00	0,55	3,50	4,10	2,44	15,53	18,19	2,86	6,70	A++
	2,00	5,00	5,00	—	—	1,61	4,19	4,19	—	—	3,20	10,00	11,00	0,55	3,50	4,10	2,44	15,53	18,19	2,86	6,70	A++
	2,00	5,00	7,10	—	—	1,46	3,80	4,74	—	—	3,20	10,00	11,00	0,55	3,50	4,10	2,44	15,53	18,19	2,86	6,70	A++
	2,50	2,50	2,50	—	—	2,60	2,60	2,60	—	—	3,20	7,80	9,50	0,55	2,78	3,80	2,44	12,33	16,86	2,81	6,72	A++
	2,50	2,50	3,50	—	—	2,60	2,60	3,60	—	—	3,20	8,80	10,00	0,55	3,14	3,80	2,44	13,93	16,86	2,80	6,72	A++
	2,50	2,50	4,20	—	—	2,60	2,60	4,40	—	—	3,20	9,60	11,00	0,55	3,40	3,80	2,44	15,08	16,86	2,82	6,74	A++
	2,50	2,50	5,00	—	—	2,50	2,50	5,00	—	—	3,20	10,00	11,00	0,55	3,50	4,10	2,44	15,53	18,19	2,86	6,74	A++
	2,50	2,50	7,10	—	—	2,22	2,22	5,56	—	—	3,20	10,00	11,00	0,55	3,50	4,10	2,44	15,53	18,19	2,86	6,70	A++
	2,50	3,50	3,50	—	—	2,60	3,60	3,60	—	—	3,20	9,80	11,00	0,55	3,45	3,80	2,44	15,31	16,86	2,84	6,73	A++
	2,50	3,50	4,20	—	—	2,45	3,40	4,15	—	—	3,20	10,00	11,00	0,55	3,50	4,10	2,44	15,53	18,19	2,86	6,70	A++
	2,50	3,50	5,00	—	—	2,28	3,16	4,56	—	—	3,20	10,00	11,00	0,55	3,50	4,10	2,44	15,53	18,19	2,86	6,70	A++
	2,50	3,50	7,10	—	—	2,05	2,83	5,12	—	—	3,20	10,00	11,00	0,55	3,50	4,10	2,44	15,53	18,19	2,86	6,70	A++
	2,50	4,20	4,20	—	—	2,28	3,86	3,86	—	—	3,20	10,00	11,00	0,55	3,50	4,10	2,44	15,53	18,19	2,86	6,70	A++
	2,50	4,20	5,00	—	—	2,13	3,61	4,26	—	—	3,20	10,00	11,00	0,55	3,50	4,10	2,44	15,53	18,19	2,86	6,70	A++
	2,50	4,20	7,10	—	—	1,93	3,26	4,81	—	—	3,20	10,00	11,00	0,55	3,50	4,10	2,44	15,53	18,19	2,86	6,70	A++
	2,50	5,00	5,00	—	—	2,00	4,00	4,00	—	—	3,20	10,00	11,00	0,55	3,50	4,10	2,44	15,53	18,19	2,86	6,70	A++
	2,50	5,00	7,10	—	—	1,82	3,64	4,55	—	—	3,20	10,00	11,00	0,55	3,50	4,10	2,44	15,53	18,19	2,86	6,70	A++
	3,50	3,50	3,50	—	—	3,33	3,33	3,33	—	—	3,20	10,00	11,00	0,55	3,50	4,10	2,44	15,53	18,19	2,86	6,75	A++
	3,50	3,50	4,20	—	—	3,10	3,10	3,79	—	—	3,20	10,00	11,00	0,55	3,50	4,10	2,44	15,53	18,19	2,86	6,70	A++
3,50	3,50	5,00	—	—	2,90	2,90	4,19	—	—	3,20	10,00	11,00	0,55	3,45	4,10	2,44	15,31	18,19	2,90	6,70	A++	
3,50	3,50	7,10	—	—	2,63	2,63	4,74	—	—	3,20	10,00	11,00	0,55	3,45	4,10	2,44	15,31	18,19	2,90	6,70	A++	
3,50	4,20	4,20	—	—	2,90	3,55	3,55	—	—	3,20	10,00	11,00	0,55	3,45	4,10	2,44	15,31	18,19	2,90	6,75	A++	
3,50	4,20	5,00	—	—	2,73	3,33	3,94	—	—	3,20	10,00	11,00	0,55	3,45	4,10	2,44	15,31	18,19	2,90	6,75	A++	
3,50	5,00	5,00	—	—	2,57	3,71	3,71	—	—	3,20	10,00	11,00	0,55	3,45	4,10	2,44	15,31	18,19	2,90	6,75	A++	
4,20	4,20	4,20	—	—	3,33	3,33	3,33	—	—	3,20	10,00	11,00	0,55	3,45	4,10	2,44	15,31	18,19	2,90	6,75	A++	

# COMBINATIONS TABLE

5U105S2SS5FA Inverter (The values in the table refer to the FLEXIS series)

COOLING																						
Combinations					Output power (kW)					System output power (kW)			Absorbed power (kW)			Absorbed current (A)			EER	SEER	Energy class	
UI	A	B	C	D	E	A	B	C	D	E	min			nom			max					
											min	nom	max	min	nom	max	min	nom	max			
4	2,00	2,00	2,00	2,00	—	2,00	2,00	2,00	2,00	—	3,20	8,00	11,00	0,55	2,80	4,00	2,44	12,42	17,75	2,86	6,80	A++
	2,00	2,00	2,00	2,50	—	2,00	2,00	2,00	2,60	—	3,20	8,60	11,00	0,55	3,00	4,00	2,44	13,31	17,75	2,87	6,80	A++
	2,00	2,00	2,00	3,50	—	2,00	2,00	2,00	3,60	—	3,20	9,60	11,00	0,55	3,30	4,00	2,44	14,64	17,75	2,91	6,80	A++
	2,00	2,00	2,00	4,20	—	1,92	1,92	1,92	4,23	—	3,20	10,00	11,00	0,55	3,40	4,10	2,44	15,08	18,19	2,94	6,80	A++
	2,00	2,00	2,00	5,00	—	1,79	1,79	1,79	4,64	—	3,20	10,00	11,00	0,55	3,40	4,10	2,44	15,08	18,19	2,94	6,80	A++
	2,00	2,00	2,00	7,10	—	1,60	1,60	1,60	5,20	—	3,20	10,00	11,00	0,55	3,40	4,10	2,44	15,08	18,19	2,94	6,70	A++
	2,00	2,00	2,50	2,50	—	2,00	2,00	2,60	2,60	—	3,20	9,20	11,00	0,55	3,20	4,00	2,44	14,20	17,75	2,88	6,80	A++
	2,00	2,00	2,50	3,50	—	1,96	1,96	2,55	3,53	—	3,20	10,00	11,00	0,55	3,40	4,10	2,44	15,08	18,19	2,94	6,80	A++
	2,00	2,00	2,50	4,20	—	1,82	1,82	2,36	4,00	—	3,20	10,00	11,00	0,55	3,40	4,10	2,44	15,08	18,19	2,94	6,80	A++
	2,00	2,00	2,50	5,00	—	1,69	1,69	2,20	4,41	—	3,20	10,00	11,00	0,55	3,40	4,10	2,44	15,08	18,19	2,94	6,80	A++
	2,00	2,00	2,50	7,10	—	1,53	1,53	1,98	4,96	—	3,20	10,00	11,00	0,55	3,40	4,10	2,44	15,08	18,19	2,94	6,70	A++
	2,00	2,00	3,50	3,50	—	1,79	1,79	3,21	3,21	—	3,20	10,00	11,00	0,55	3,40	4,10	2,44	15,08	18,19	2,94	6,80	A++
	2,00	2,00	3,50	4,20	—	1,67	1,67	3,00	3,67	—	3,20	10,00	11,00	0,55	3,40	4,10	2,44	15,08	18,19	2,94	6,70	A++
	2,00	2,00	3,50	5,00	—	1,56	1,56	2,81	4,06	—	3,20	10,00	11,00	0,55	3,40	4,10	2,44	15,08	18,19	2,94	6,70	A++
	2,00	2,00	3,50	7,10	—	1,42	1,42	2,55	4,61	—	3,20	10,00	11,00	0,55	3,40	4,10	2,44	15,08	18,19	2,94	6,70	A++
	2,00	2,00	4,20	4,20	—	1,56	1,56	3,44	3,44	—	3,20	10,00	11,00	0,55	3,40	4,10	2,44	15,08	18,19	2,94	6,90	A++
	2,00	2,00	4,20	5,00	—	1,47	1,47	3,24	3,82	—	3,20	10,00	11,00	0,55	3,40	4,10	2,44	15,08	18,19	2,94	6,90	A++
	2,00	2,00	5,00	5,00	—	1,39	1,39	3,61	3,61	—	3,20	10,00	11,00	0,55	3,40	4,10	2,44	15,08	18,19	2,94	6,90	A++
	2,00	2,50	2,50	2,50	—	2,00	2,60	2,60	2,60	—	3,20	9,80	11,00	0,55	3,37	4,00	2,44	14,95	17,75	2,91	6,90	A++
	2,00	2,50	2,50	3,50	—	1,85	2,41	2,41	3,33	—	3,20	10,00	11,00	0,55	3,40	4,10	2,44	15,08	18,19	2,94	6,90	A++
	2,00	2,50	2,50	4,20	—	1,72	2,24	2,24	3,79	—	3,20	10,00	11,00	0,55	3,40	4,10	2,44	15,08	18,19	2,94	6,90	A++
	2,00	2,50	2,50	5,00	—	1,61	2,10	2,10	4,19	—	3,20	10,00	11,00	0,55	3,40	4,10	2,44	15,08	18,19	2,94	6,90	A++
	2,00	2,50	2,50	7,10	—	1,46	1,90	1,90	4,74	—	3,20	10,00	11,00	0,55	3,40	4,10	2,44	15,08	18,19	2,94	6,90	A++
	2,00	2,50	3,50	3,50	—	1,69	2,20	3,05	3,05	—	3,20	10,00	11,00	0,55	3,38	4,10	2,44	15,00	18,19	2,96	6,90	A++
	2,00	2,50	3,50	4,20	—	1,59	2,06	2,86	3,49	—	3,20	10,00	11,00	0,55	3,38	4,10	2,44	15,00	18,19	2,96	6,90	A++
	2,00	2,50	3,50	5,00	—	1,49	1,94	2,69	3,88	—	3,20	10,00	11,00	0,55	3,38	4,10	2,44	15,00	18,19	2,96	6,90	A++
	2,00	2,50	4,20	4,20	—	1,49	1,94	3,28	3,28	—	3,20	10,00	11,00	0,55	3,38	4,10	2,44	15,00	18,19	2,96	6,90	A++
	2,00	2,50	4,20	5,00	—	1,41	1,83	3,10	3,66	—	3,20	10,00	11,00	0,55	3,38	4,10	2,44	15,00	18,19	2,96	6,90	A++
	2,00	2,50	5,00	5,00	—	1,33	1,73	3,47	3,47	—	3,20	10,00	11,00	0,55	3,38	4,10	2,44	15,00	18,19	2,96	6,90	A++
	2,00	3,50	3,50	3,50	—	1,56	2,81	2,81	2,81	—	3,20	10,00	11,00	0,55	3,38	4,10	2,44	15,00	18,19	2,96	6,90	A++
	2,00	3,50	3,50	4,20	—	1,47	2,65	2,65	3,24	—	3,20	10,00	11,00	0,55	3,38	4,10	2,44	15,00	18,19	2,96	6,90	A++
	2,00	3,50	3,50	5,00	—	1,39	2,50	2,50	3,61	—	3,20	10,00	11,00	0,55	3,36	4,10	2,44	14,91	18,19	2,98	6,90	A++
	2,00	3,50	4,20	4,20	—	1,39	2,50	3,06	3,06	—	3,20	10,00	11,00	0,55	3,36	4,10	2,44	14,91	18,19	2,98	6,90	A++
	2,00	3,50	4,20	5,00	—	1,32	2,37	2,89	3,42	—	3,20	10,00	11,00	0,55	3,36	4,10	2,44	14,91	18,19	2,98	6,90	A++
	2,00	4,20	4,20	4,20	—	1,32	2,89	2,89	2,89	—	3,20	10,00	11,00	0,55	3,36	4,10	2,44	14,91	18,19	2,98	6,90	A++
	2,50	2,50	2,50	2,50	—	2,50	2,50	2,50	2,50	—	3,20	10,00	11,00	0,55	3,36	4,10	2,44	14,91	18,19	2,98	6,90	A++
	2,50	2,50	2,50	3,50	—	2,28	2,28	2,28	3,16	—	3,20	10,00	11,00	0,55	3,36	4,10	2,44	14,91	18,19	2,98	6,90	A++
	2,50	2,50	2,50	4,20	—	2,13	2,13	2,13	3,61	—	3,20	10,00	11,00	0,55	3,36	4,10	2,44	14,91	18,19	2,98	6,90	A++
	2,50	2,50	2,50	5,00	—	2,00	2,00	2,00	4,00	—	3,20	10,00	11,00	0,55	3,36	4,10	2,44	14,91	18,19	2,98	6,90	A++
	2,50	2,50	2,50	7,10	—	1,82	1,82	1,82	4,55	—	3,20	10,00	11,00	0,55	3,36	4,10	2,44	14,91	18,19	2,98	6,90	A++
	2,50	2,50	3,50	3,50	—	2,10	2,10	2,90	2,90	—	3,20	10,00	11,00	0,55	3,36	4,10	2,44	14,91	18,19	2,98	6,90	A++
	2,50	2,50	3,50	4,20	—	1,97	1,97	2,73	3,33	—	3,20	10,00	11,00	0,55	3,36	4,10	2,44	14,91	18,19	2,98	7,00	A++
	2,50	2,50	3,50	5,00	—	1,86	1,86	2,57	3,71	—	3,20	10,00	11,00	0,55	3,33	4,10	2,44	14,77	18,19	3,00	7,00	A++
	2,50	2,50	4,20	4,20	—	1,86	1,86	3,14	3,14	—	3,20	10,00	11,00	0,55	3,33	4,10	2,44	14,77	18,19	3,00	7,00	A++
	2,50	2,50	4,20	5,00	—	1,76	1,76	2,97	3,51	—	3,20	10,00	11,00	0,55	3,33	4,10	2,44	14,77	18,19	3,00	7,00	A++
2,50	2,50	5,00	5,00	—	1,67	1,67	3,33	3,33	—	3,20	10,00	11,00	0,55	3,33	4,10	2,44	14,77	18,19	3,00	7,00	A++	
2,50	3,50	3,50	3,50	—	1,94	2,69	2,69	2,69	—	3,20	10,00	11,00	0,55	3,33	4,10	2,44	14,77	18,19	3,00	7,00	A++	
2,50	3,50	3,50	4,20	—	1,83	2,54	2,54	3,10	—	3,20	10,00	11,00	0,55	3,33	4,10	2,44	14,77	18,19	3,00	7,00	A++	
2,50	3,50	3,50	5,00	—	1,73	2,40	2,40	3,47	—	3,20	10,00	11,00	0,55	3,33	4,10	2,44	14,77	18,19	3,00	7,00	A++	
2,50	3,50	4,20	4,20	—	1,73	2,40	2,93	2,93	—	3,20	10,00	11,00	0,55	3,33	4,10	2,44	14,77	18,19	3,00	7,00	A++	
3,50	3,50	3,50	3,50	—	2,50	2,50	2,50	2,50	—	3,20	10,00	11,00	0,55	3,33	4,10	2,44	14,77	18,19	3,00	7,00	A++	
3,50	3,50	3,50	4,20	—	2,37	2,37	2,37	2,89	—	3,20	10,00	11,00	0,55	3,33	4,10	2,44	14,77	18,19	3,00	7,00	A++	
5	2,00	2,00	2,00	2,00	2,00	2,00	2,00	2,00	2,00	2,00	3,20	10,00	11,00	0,55	3,33	4,10	2,44	14,77	18,19	3,00	7,00	A++
	2,00	2,00	2,00	2,00	2,50	1,89	1,89	1,89	1,89	2,45	3,20	10,00	11,00	0,55	3,33	4,10	2,44	14,77	18,19	3,00	7,00	A++
	2,00	2,00	2,00	2,00	3,50	1,72	1,72	1,72	1,72	3,10	3,20	10,00	11,00	0,55	3,33	4,10	2,44	14,77	18,19	3,00	7,00	A++
	2,00	2,00	2,00	2,00	4,20	1,61	1,61	1,61	1,61	3,55	3,20	10,00	11,00	0,55	3,33	4,10	2,44	14,77	18,19	3,00	7,00	A++
	2,00	2,00	2,00	2,00	5,00	1,52	1,52	1,52	1,52	3,94	3,20	10,00	11,00	0,55	3,33	4,10	2,44	14,77	18,19	3,00	7,00	A++
	2,00	2,00	2,00	2,50	2,50	1,79	1,79	1,79	2,32	2,32	3,20	10,00	11,00	0,55	3,33	4,10	2,44	14,77	18,19	3,00	7,00	A++
	2,00	2,00	2,00	2,50	3,50	1,64	1,64	1,64	2,13	2,95	3,20	10,00	11,00	0,55	3,33	4,10	2,44	14,77	18,19	3,00	7,00	A++
	2,00	2,00	2,00	2,50	4,20	1,54	1,54															

5U105S2SS5FA Inverter (The values in the table refer to the FLEXIS series)

HEATING																						
Combinations					Output power (kW)					System output power (kW)			Absorbed power (kW)			Absorbed current (A)			COP	SCOP	Energy class	
UI	A	B	C	D	E	A	B	C	D	E	min	nom	max	min	nom	max	min	nom	max			
2	2,00	2,00	—	—	—	2,30	2,30	—	—	—	2,80	4,60	8,00	0,55	1,30	3,30	2,44	5,77	14,64	3,54	3,75	A
	2,00	2,50	—	—	—	2,30	3,60	—	—	—	3,00	5,90	10,00	0,55	1,66	3,30	2,44	7,36	14,64	3,55	3,75	A
	2,00	3,50	—	—	—	2,30	4,50	—	—	—	3,20	6,80	10,00	0,55	1,90	3,30	2,44	8,43	14,64	3,58	3,75	A
	2,00	4,20	—	—	—	2,30	5,40	—	—	—	3,40	7,70	10,00	0,55	2,15	3,30	2,44	9,54	14,64	3,58	3,80	A
	2,00	5,00	—	—	—	2,30	6,00	—	—	—	3,80	8,30	11,50	0,55	2,29	3,30	2,44	10,16	14,64	3,62	3,80	A
	2,00	7,10	—	—	—	2,30	7,00	—	—	—	4,00	9,30	11,50	0,55	2,55	3,30	2,44	11,31	14,64	3,65	3,85	A
	2,50	2,50	—	—	—	3,60	3,60	—	—	—	3,40	7,20	10,50	0,55	2,02	3,30	2,44	8,96	14,64	3,56	3,85	A
	2,50	3,50	—	—	—	3,60	4,50	—	—	—	3,80	8,10	10,50	0,55	2,26	3,30	2,44	10,03	14,64	3,58	3,83	A
	2,50	4,20	—	—	—	3,60	5,40	—	—	—	4,00	9,00	10,50	0,55	2,50	3,30	2,44	11,09	14,64	3,60	3,87	A
	2,50	5,00	—	—	—	3,60	6,00	—	—	—	4,40	9,60	10,50	0,55	2,64	3,30	2,44	11,71	14,64	3,64	3,85	A
	2,50	7,10	—	—	—	3,57	6,93	—	—	—	4,40	10,50	11,00	0,55	2,85	3,30	2,44	12,64	14,64	3,68	3,84	A
	3,50	3,50	—	—	—	4,50	4,50	—	—	—	4,00	9,00	10,50	0,55	2,50	3,30	2,44	11,09	14,64	3,60	3,86	A
	3,50	4,20	—	—	—	4,50	5,40	—	—	—	4,40	9,90	10,50	0,55	2,74	3,30	2,44	12,16	14,64	3,61	3,82	A
	3,50	5,00	—	—	—	4,50	6,00	—	—	—	4,40	10,50	11,50	0,55	2,88	3,30	2,44	12,78	14,64	3,65	3,80	A
	3,50	7,10	—	—	—	4,11	6,39	—	—	—	4,40	10,50	11,50	0,55	2,88	3,30	2,44	12,78	14,64	3,65	3,84	A
	4,20	4,20	—	—	—	5,25	5,25	—	—	—	4,40	10,50	11,50	0,55	2,88	3,30	2,44	12,78	14,64	3,65	3,86	A
	4,20	5,00	—	—	—	4,97	5,53	—	—	—	4,40	10,50	11,50	0,55	2,88	3,30	2,44	12,78	14,64	3,65	3,83	A
	4,20	7,10	—	—	—	4,57	5,93	—	—	—	4,40	10,50	11,50	0,55	2,88	3,30	2,44	12,78	14,64	3,65	3,86	A
	5,00	5,00	—	—	—	5,25	5,25	—	—	—	4,40	10,50	11,50	0,55	2,91	3,30	2,44	12,91	14,64	3,61	3,80	A
	5,00	7,10	—	—	—	4,85	5,65	—	—	—	4,40	9,50	11,50	0,55	2,88	3,30	2,44	12,78	14,64	3,30	3,87	A
7,10	7,10	—	—	—	5,25	5,25	—	—	—	4,40	10,50	11,50	0,55	2,88	3,30	2,44	12,78	14,64	3,65	3,85	A	
3	2,00	2,00	2,00	—	—	2,30	2,30	2,30	—	—	3,80	6,90	11,50	0,55	1,93	3,40	2,44	8,56	15,08	3,58	3,80	A
	2,00	2,00	2,50	—	—	2,30	2,30	3,60	—	—	4,00	8,20	11,50	0,55	2,28	3,40	2,44	10,12	15,08	3,60	3,80	A
	2,00	2,00	3,50	—	—	2,30	2,30	4,50	—	—	4,20	9,10	11,50	0,55	2,50	3,40	2,44	11,09	15,08	3,64	3,80	A
	2,00	2,00	4,20	—	—	2,30	2,30	5,40	—	—	4,40	10,00	11,50	0,55	2,73	3,40	2,44	12,11	15,08	3,66	3,80	A
	2,00	2,00	5,00	—	—	2,28	2,28	5,94	—	—	4,40	10,50	11,50	0,55	2,88	3,40	2,44	12,78	15,08	3,65	3,80	A
	2,00	2,00	7,10	—	—	2,08	2,08	6,34	—	—	4,40	10,50	11,50	0,55	2,88	3,40	2,44	12,78	15,08	3,65	3,80	A
	2,00	2,50	2,50	—	—	2,30	3,60	3,60	—	—	4,40	9,50	11,50	0,55	2,63	3,40	2,44	11,67	15,08	3,61	3,80	A
	2,00	2,50	3,50	—	—	2,30	3,60	4,50	—	—	4,40	10,40	11,50	0,55	2,88	3,40	2,44	12,78	15,08	3,61	3,80	A
	2,00	2,50	4,20	—	—	2,14	3,35	5,02	—	—	4,40	10,50	11,50	0,55	2,88	3,40	2,44	12,78	15,08	3,65	3,80	A
	2,00	2,50	5,00	—	—	2,03	3,18	5,29	—	—	4,40	10,50	11,50	0,55	2,88	3,40	2,44	12,78	15,08	3,65	3,82	A
	2,00	2,50	7,10	—	—	1,87	2,93	5,70	—	—	4,40	10,50	11,50	0,55	2,88	3,40	2,44	12,78	15,08	3,65	3,82	A
	2,00	3,50	3,50	—	—	2,14	4,18	4,18	—	—	4,40	10,50	11,50	0,55	2,88	3,40	2,44	12,78	15,08	3,65	3,82	A
	2,00	3,50	4,20	—	—	1,98	3,87	4,65	—	—	4,40	10,50	11,50	0,55	2,88	3,40	2,44	12,78	15,08	3,65	3,82	A
	2,00	3,50	5,00	—	—	1,89	3,69	4,92	—	—	4,40	10,50	11,50	0,55	2,88	3,40	2,44	12,78	15,08	3,65	3,82	A
	2,00	3,50	7,10	—	—	1,75	3,42	5,33	—	—	4,40	10,50	11,50	0,55	2,86	3,40	2,44	12,69	15,08	3,67	3,82	A
	2,00	4,20	4,20	—	—	1,84	4,33	4,33	—	—	4,40	10,50	11,50	0,55	2,86	3,40	2,44	12,69	15,08	3,67	3,82	A
	2,00	4,20	5,00	—	—	1,76	4,14	4,60	—	—	4,40	10,50	11,50	0,55	2,86	3,40	2,44	12,69	15,08	3,67	3,82	A
	2,00	4,20	7,10	—	—	1,64	3,86	5,00	—	—	4,40	10,50	11,50	0,55	2,86	3,40	2,44	12,69	15,08	3,67	3,87	A
	2,00	5,00	5,00	—	—	1,69	4,41	4,41	—	—	4,40	10,50	11,50	0,55	2,86	3,40	2,44	12,69	15,08	3,67	3,87	A
	2,00	5,00	7,10	—	—	1,58	4,12	4,80	—	—	4,40	10,50	11,50	0,55	2,86	3,40	2,44	12,69	15,08	3,67	3,87	A
	2,50	2,50	2,50	—	—	3,50	3,50	3,50	—	—	4,40	10,50	11,50	0,55	2,85	3,40	2,44	12,64	15,08	3,68	3,87	A
	2,50	2,50	3,50	—	—	3,23	3,23	4,04	—	—	4,40	10,50	11,50	0,55	2,85	3,40	2,44	12,64	15,08	3,68	3,87	A
	2,50	2,50	4,20	—	—	3,00	3,00	4,50	—	—	4,40	10,50	11,50	0,55	2,85	3,40	2,44	12,64	15,08	3,68	3,87	A
	2,50	2,50	5,00	—	—	2,86	2,86	4,77	—	—	4,40	10,50	11,50	0,55	2,85	3,40	2,44	12,64	15,08	3,68	3,87	A
	2,50	2,50	7,10	—	—	2,66	2,66	5,18	—	—	4,40	10,50	11,50	0,55	2,85	3,40	2,44	12,64	15,08	3,68	3,90	A
	2,50	3,50	3,50	—	—	3,00	3,75	3,75	—	—	4,40	10,50	11,50	0,55	2,85	3,40	2,44	12,64	15,08	3,68	3,85	A
	2,50	3,50	4,20	—	—	2,80	3,50	4,20	—	—	4,40	10,50	11,50	0,55	2,85	3,40	2,44	12,64	15,08	3,68	3,85	A
	2,50	3,50	5,00	—	—	2,68	3,35	4,47	—	—	4,40	10,50	11,50	0,55	2,85	3,40	2,44	12,64	15,08	3,68	3,85	A
	2,50	3,50	7,10	—	—	2,50	3,13	4,87	—	—	4,40	10,50	11,50	0,55	2,85	3,40	2,44	12,64	15,08	3,68	3,85	A
	2,50	4,20	4,20	—	—	2,63	3,94	3,94	—	—	4,40	10,50	11,50	0,55	2,85	3,40	2,44	12,64	15,08	3,68	3,85	A
	2,50	4,20	5,00	—	—	2,52	3,78	4,20	—	—	4,40	10,50	11,50	0,55	2,85	3,40	2,44	12,64	15,08	3,68	3,85	A
	2,50	4,20	7,10	—	—	2,36	3,54	4,59	—	—	4,40	10,50	11,50	0,55	2,85	3,40	2,44	12,64	15,08	3,68	3,85	A
	2,50	5,00	5,00	—	—	2,42	4,04	4,04	—	—	4,40	10,50	11,50	0,55	2,85	3,40	2,44	12,64	15,08	3,68	3,85	A
	2,50	5,00	7,10	—	—	2,28	3,80	4,43	—	—	4,40	10,50	11,50	0,55	2,85	3,40	2,44	12,64	15,08	3,68	3,85	A
	3,50	3,50	3,50	—	—	3,50	3,50	3,50	—	—	4,40	10,50	11,50	0,55	2,85	3,40	2,44	12,64	15,08	3,68	3,90	A
	3,50	3,50	4,20	—	—	3,28	3,28	3,94	—	—	4,40	10,50	11,50	0,55	2,85	3,40	2,44	12,64	15,08	3,68	3,90	A
	3,50	3,50	5,00	—	—	3,15	3,15	4,20	—	—	4,40	10,50	11,50	0,55	2,83	3,40	2,44	12,56	15,08	3,71	3,90	A
	3,50	3,50	7,10	—	—	2,95	2,95	4,59	—	—	4,40	10,50	11,50	0,55	2,83	3,40	2,44	12,56	15,08	3,71	3,85	A
	3,50	4,20	4,20	—	—	3,09	3,71	3,71	—	—	4,40	10,50	11,50	0,55	2,83	3,40	2,44	12,56	15,08	3,71	3,90	A
	3,50	4,20	5,00	—	—	2,97	3,57	3,96	—	—	4,40	10,50	11,50	0,55	2,83	3,40	2,44	12,56	15,08	3,71	3,90	A
3,50	5,00	5,00	—	—	2,86	3,82	3,82	—	—	4,40	10,50	11,50	0,55	2,83	3,40	2,44	12,56	15,08	3,71	3,90	A	
4,20	4,20	4,20	—	—	3,50	3,50	3,50	—	—	4,40	10,50	11,50	0,55	2,83	3,40	2,44	12,56	15,08	3,71	3,90	A	
4,20	4,20	5,0																				

# COMBINATIONS TABLE

5U105S2SS5FA Inverter (The values in the table refer to the FLEXIS series)

HEATING																							
UI	Combinations					Output power (kW)					System output power (kW)			Absorbed power (kW)			Absorbed current (A)			COP	SCOP	Energy class	
	A	B	C	D	E	A	B	C	D	E	min	nom	max	min	nom	max	min	nom	max				max
4	2,00	2,00	2,00	2,00	—	2,30	2,30	2,30	2,30	—	4,20	9,20	11,50	0,55	2,55	3,40	2,44	11,31	15,08	3,61	3,85	A	
	2,00	2,00	2,00	2,50	—	2,30	2,30	2,30	3,60	—	4,20	10,50	11,50	0,55	2,84	3,40	2,44	12,60	15,08	3,70	3,85	A	
	2,00	2,00	2,00	3,50	—	2,12	2,12	2,12	4,14	—	4,40	10,50	11,50	0,55	2,84	3,40	2,44	12,60	15,08	3,70	3,85	A	
	2,00	2,00	2,00	4,20	—	1,96	1,96	1,96	4,61	—	4,40	10,50	11,50	0,55	2,84	3,40	2,44	12,60	15,08	3,70	3,85	A	
	2,00	2,00	2,00	5,00	—	1,87	1,87	1,87	4,88	—	4,40	10,50	11,50	0,55	2,84	3,40	2,44	12,60	15,08	3,70	3,85	A	
	2,00	2,00	2,00	7,10	—	1,74	1,74	1,74	5,29	—	4,40	10,50	11,50	0,55	2,84	3,40	2,44	12,60	15,08	3,70	3,85	A	
	2,00	2,00	2,50	2,50	—	2,05	2,05	3,20	3,20	—	4,40	10,50	11,50	0,55	2,84	3,40	2,44	12,60	15,08	3,70	3,85	A	
	2,00	2,00	2,50	3,50	—	1,90	1,90	2,98	3,72	—	4,40	10,50	11,50	0,55	2,83	3,40	2,44	12,56	15,08	3,71	3,85	A	
	2,00	2,00	2,50	4,20	—	1,78	1,78	2,78	4,17	—	4,40	10,50	11,50	0,55	2,83	3,40	2,44	12,56	15,08	3,71	3,90	A	
	2,00	2,00	2,50	5,00	—	1,70	1,70	2,66	4,44	—	4,40	10,50	11,50	0,55	2,83	3,40	2,44	12,56	15,08	3,71	3,90	A	
	2,00	2,00	2,50	7,10	—	1,59	1,59	2,49	4,84	—	4,40	10,50	11,50	0,55	2,83	3,40	2,44	12,56	15,08	3,71	3,90	A	
	2,00	2,00	3,50	3,50	—	1,78	1,78	3,47	3,47	—	4,40	10,50	11,50	0,55	2,83	3,40	2,44	12,56	15,08	3,71	3,90	A	
	2,00	2,00	3,50	4,20	—	1,67	1,67	3,26	3,91	—	4,40	10,50	11,50	0,55	2,83	3,40	2,44	12,56	15,08	3,71	3,90	A	
	2,00	2,00	3,50	5,00	—	1,60	1,60	3,13	4,17	—	4,40	10,50	11,50	0,55	2,81	3,40	2,44	12,47	15,08	3,74	3,90	A	
	2,00	2,00	3,50	7,10	—	1,50	1,50	2,93	4,57	—	4,40	10,50	11,50	0,55	2,81	3,40	2,44	12,47	15,08	3,74	3,90	A	
	2,00	2,00	4,20	4,20	—	1,57	1,57	3,68	3,68	—	4,40	10,50	11,50	0,55	2,81	3,40	2,44	12,47	15,08	3,74	3,90	A	
	2,00	2,00	4,20	5,00	—	1,51	1,51	3,54	3,94	—	4,40	10,50	11,50	0,55	2,81	3,40	2,44	12,47	15,08	3,74	3,90	A	
	2,00	2,00	5,00	5,00	—	1,45	1,45	3,80	3,80	—	4,40	10,50	11,50	0,55	2,81	3,40	2,44	12,47	15,08	3,74	3,90	A	
	2,00	2,50	2,50	2,50	—	1,84	2,89	2,89	2,89	—	4,40	10,50	11,50	0,55	2,81	3,40	2,44	12,47	15,08	3,74	3,90	A	
	2,00	2,50	2,50	3,50	—	1,73	2,70	2,70	3,38	—	4,40	10,50	11,50	0,55	2,80	3,40	2,44	12,42	15,08	3,75	3,90	A	
	2,00	2,50	2,50	4,20	—	1,62	2,54	2,54	3,81	—	4,40	10,50	11,50	0,55	2,80	3,40	2,44	12,42	15,08	3,75	3,95	A	
	2,00	2,50	2,50	5,00	—	1,56	2,44	2,44	4,06	—	4,40	10,50	11,50	0,55	2,80	3,40	2,44	12,42	15,08	3,75	3,95	A	
	2,00	2,50	2,50	7,10	—	1,46	2,29	2,29	4,45	—	4,40	10,50	11,50	0,55	2,80	3,40	2,44	12,42	15,08	3,75	3,95	A	
	2,00	2,50	3,50	3,50	—	1,62	2,54	3,17	3,17	—	4,40	10,50	11,50	0,55	2,80	3,40	2,44	12,42	15,08	3,75	3,95	A	
	2,00	2,50	3,50	4,20	—	1,53	2,39	2,99	3,59	—	4,40	10,50	11,50	0,55	2,80	3,40	2,44	12,42	15,08	3,75	3,95	A	
	2,00	2,50	3,50	5,00	—	1,47	2,30	2,88	3,84	—	4,40	10,50	11,50	0,55	2,80	3,40	2,44	12,42	15,08	3,75	3,95	A	
	2,00	2,50	4,20	4,20	—	1,45	2,26	3,40	3,40	—	4,40	10,50	11,50	0,55	2,80	3,40	2,44	12,42	15,08	3,75	3,95	A	
	2,00	2,50	4,20	5,00	—	1,40	2,18	3,28	3,64	—	4,40	10,50	11,50	0,55	2,80	3,40	2,44	12,42	15,08	3,75	3,95	A	
	2,00	2,50	5,00	5,00	—	1,35	2,11	3,52	3,52	—	4,40	10,50	11,50	0,55	2,78	3,40	2,44	12,33	15,08	3,78	3,95	A	
	2,00	3,50	3,50	3,50	—	1,53	2,99	2,99	2,99	—	4,40	10,50	11,50	0,55	2,78	3,40	2,44	12,33	15,08	3,78	3,95	A	
	2,00	3,50	3,50	4,20	—	1,45	2,83	2,83	3,40	—	4,40	10,50	11,50	0,55	2,78	3,40	2,44	12,33	15,08	3,78	4,00	A+	
	2,00	3,50	3,50	5,00	—	1,40	2,73	2,73	3,64	—	4,40	10,50	11,50	0,55	2,78	3,40	2,44	12,33	15,08	3,78	4,00	A+	
	2,00	3,50	4,20	4,20	—	1,37	2,68	3,22	3,22	—	4,40	10,50	11,50	0,55	2,78	3,40	2,44	12,33	15,08	3,78	4,00	A+	
	2,00	3,50	4,20	5,00	—	1,33	2,60	3,12	3,46	—	4,40	10,50	11,50	0,55	2,78	3,40	2,44	12,33	15,08	3,78	4,00	A+	
	2,00	4,20	4,20	4,20	—	1,31	3,06	3,06	3,06	—	4,40	10,50	11,50	0,55	2,78	3,40	2,44	12,33	15,08	3,78	4,00	A+	
	2,50	2,50	2,50	2,50	—	2,63	2,63	2,63	2,63	—	4,40	10,50	11,50	0,55	2,76	3,40	2,44	12,24	15,08	3,80	4,00	A+	
	2,50	2,50	2,50	3,50	—	2,47	2,47	2,47	3,09	—	4,40	10,50	11,50	0,55	2,76	3,40	2,44	12,24	15,08	3,80	4,00	A+	
	2,50	2,50	2,50	4,20	—	2,33	2,33	2,33	3,50	—	4,40	10,50	11,50	0,55	2,76	3,40	2,44	12,24	15,08	3,80	4,00	A+	
	2,50	2,50	2,50	5,00	—	2,25	2,25	2,25	3,75	—	4,40	10,50	11,50	0,55	2,76	3,40	2,44	12,24	15,08	3,80	4,00	A+	
	2,50	2,50	2,50	7,10	—	2,12	2,12	2,12	4,13	—	4,40	10,50	11,50	0,55	2,76	3,40	2,44	12,24	15,08	3,80	4,00	A+	
	2,50	2,50	3,50	3,50	—	2,33	2,33	2,92	2,92	—	4,40	10,50	11,50	0,55	2,76	3,40	2,44	12,24	15,08	3,80	4,00	A+	
	2,50	2,50	3,50	4,20	—	2,21	2,21	2,76	3,32	—	4,40	10,50	11,50	0,55	2,76	3,40	2,44	12,24	15,08	3,80	4,00	A+	
2,50	2,50	3,50	5,00	—	2,14	2,14	2,67	3,56	—	4,40	10,50	11,50	0,55	2,76	3,40	2,44	12,24	15,08	3,80	4,00	A+		
2,50	2,50	4,20	4,20	—	2,10	2,10	3,15	3,15	—	4,40	10,50	11,50	0,55	2,76	3,40	2,44	12,24	15,08	3,80	4,00	A+		
2,50	2,50	4,20	5,00	—	2,03	2,03	3,05	3,39	—	4,40	10,50	11,50	0,55	2,76	3,40	2,44	12,24	15,08	3,80	4,00	A+		
2,50	2,50	5,00	5,00	—	1,97	1,97	3,28	3,28	—	4,40	10,50	11,50	0,55	2,76	3,40	2,44	12,24	15,08	3,80	4,00	A+		
2,50	3,50	3,50	3,50	—	2,21	2,76	2,76	2,76	—	4,40	10,50	11,50	0,55	2,76	3,40	2,44	12,24	15,08	3,80	4,00	A+		
2,50	3,50	3,50	4,20	—	2,10	2,63	2,63	3,15	—	4,40	10,50	11,50	0,55	2,76	3,40	2,44	12,24	15,08	3,80	4,00	A+		
2,50	3,50	3,50	5,00	—	2,03	2,54	2,54	3,39	—	4,40	10,50	11,50	0,55	2,76	3,40	2,44	12,24	15,08	3,80	4,00	A+		
2,50	3,50	4,20	4,20	—	2,00	2,50	3,00	3,00	—	4,40	10,50	11,50	0,55	2,76	3,40	2,44	12,24	15,08	3,80	4,00	A+		
3,50	3,50	3,50	3,50	—	2,63	2,63	2,63	2,63	—	4,40	10,50	11,50	0,55	2,76	3,40	2,44	12,24	15,08	3,80	4,00	A+		
3,50	3,50	3,50	4,20	—	2,50	2,50	2,50	3,00	—	4,40	10,50	11,50	0,55	2,76	3,40	2,44	12,24	15,08	3,80	4,00	A+		
5	2,00	2,00	2,00	2,00	2,00	2,10	2,10	2,10	2,10	2,10	4,20	10,50	11,50	0,55	2,76	3,40	2,44	12,24	15,08	3,80	4,00	A+	
	2,00	2,00	2,00	2,00	2,50	1,89	1,89	1,89	1,89	2,95	4,20	10,50	11,50	0,55	2,76	3,40	2,44	12,24	15,08	3,80	4,00	A+	
	2,00	2,00	2,00	2,00	3,50	1,76	1,76	1,76	1,76	3,45	4,20	10,50	11,50	0,55	2,76	3,40	2,44	12,24	15,08	3,80	4,00	A+	
	2,00	2,00	2,00	2,00	4,20	1,65	1,65	1,65	1,65	3,88	4,20	10,50	11,50	0,55	2,76	3,40	2,44	12,24	15,08	3,80	4,00	A+	
	2,00	2,00	2,00	2,00	5,00	1,59	1,59	1,59	1,59	4,14	4,20	10,50	11,50	0,55	2,76	3,40	2,44	12,24	15,08	3,80	4,00	A+	
	2,00	2,00	2,00	2,50	2,50	1,71	1,71	1,71	2,68	2,68	4,20	10,50	11,50	0,55	2,76	3,40	2,44	12,24	15,08	3,80	4,00	A+	
	2,00	2,00	2,00	2,50	3,50	1,61	1,61	1,61	2,52	3,15	4,20	10,50	11,50	0,55	2,76	3,40	2,44	12,24	15,08	3,80	4,00	A+	
	2,00	2,00	2,00	2,50	4,20	1,52	1,52	1,52	2,38	3,57	4,20	10,50	11,50	0,55	2,76	3,40	2,44	12,24	15,08	3,80	4,00	A+	



## 5U125S2SN1FA Inverter (The values in the table refer to the FLEXIS series)

COOLING																						
Combinations					Output power (kW)					System output power (kW)			Absorbed power (kW)			Absorbed current (A)			EER	SEER	Energy class	
UI	A	B	C	D	E	A	B	C	D	E	min	nom	max	min	nom	max	min	nom	max			
2	2,00	2,00	—	—	—	2,00	2,00	—	—	—	2,50	4,00	5,60	0,55	1,50	3,60	2,44	6,65	15,97	2,97	6,20	A++
	2,00	2,50	—	—	—	2,00	2,60	—	—	—	2,50	4,60	6,70	0,55	1,54	3,60	2,44	6,83	15,97	2,99	6,20	A++
	2,00	3,50	—	—	—	2,00	3,60	—	—	—	2,50	5,60	8,10	0,55	1,86	3,60	2,44	8,25	15,97	3,01	6,20	A++
	2,00	4,20	—	—	—	2,00	4,40	—	—	—	2,50	6,40	7,80	0,55	2,12	3,60	2,44	9,41	15,97	3,02	6,20	A++
	2,00	5,00	—	—	—	2,00	5,20	—	—	—	2,50	7,20	9,30	0,55	2,38	3,60	2,44	10,56	15,97	3,03	6,20	A++
	2,00	7,10	—	—	—	2,00	6,50	—	—	—	2,50	8,50	9,30	0,55	2,80	3,60	2,44	12,42	15,97	3,04	6,20	A++
	2,50	2,50	—	—	—	2,60	2,60	—	—	—	2,50	5,20	7,80	0,55	1,73	3,60	2,44	7,68	15,97	3,01	6,20	A++
	2,50	3,50	—	—	—	2,60	3,60	—	—	—	2,50	6,20	9,10	0,55	2,05	3,60	2,44	9,09	15,97	3,02	6,20	A++
	2,50	4,20	—	—	—	2,60	4,40	—	—	—	2,50	7,00	9,30	0,55	2,31	3,60	2,44	10,25	15,97	3,03	6,20	A++
	2,50	5,00	—	—	—	2,60	5,20	—	—	—	2,50	7,80	9,30	0,55	2,57	3,60	2,44	11,40	15,97	3,04	6,20	A++
	2,50	7,10	—	—	—	2,60	6,50	—	—	—	2,50	9,10	9,30	0,55	2,98	3,60	2,44	13,22	15,97	3,05	6,20	A++
	3,50	3,50	—	—	—	3,60	3,60	—	—	—	2,50	7,20	9,30	0,55	2,38	3,60	2,44	10,56	15,97	3,03	6,20	A++
	3,50	4,20	—	—	—	3,60	4,40	—	—	—	2,50	8,00	9,30	0,55	2,63	3,60	2,44	11,67	15,97	3,04	6,20	A++
	3,50	5,00	—	—	—	3,60	5,20	—	—	—	2,50	8,80	10,00	0,55	2,89	3,60	2,44	12,82	15,97	3,04	6,20	A++
	3,50	7,10	—	—	—	3,60	6,50	—	—	—	2,50	10,10	13,80	0,55	3,31	3,60	2,44	14,69	15,97	3,05	6,20	A++
	4,20	4,20	—	—	—	4,40	4,40	—	—	—	2,50	8,80	10,00	0,55	2,89	3,60	2,44	12,82	15,97	3,04	6,20	A++
	4,20	5,00	—	—	—	4,40	5,20	—	—	—	2,50	9,60	10,50	0,55	3,14	3,60	2,44	13,93	15,97	3,06	6,20	A++
	4,20	7,10	—	—	—	4,40	6,50	—	—	—	2,50	10,90	13,80	0,55	3,55	3,60	2,44	15,75	15,97	3,07	6,20	A++
5,00	5,00	—	—	—	5,20	5,20	—	—	—	2,50	10,40	13,80	0,55	3,39	3,60	2,44	15,03	15,97	3,07	6,20	A++	
5,00	7,10	—	—	—	5,20	6,50	—	—	—	2,50	11,70	13,80	0,55	3,80	3,60	2,44	16,85	15,97	3,08	6,20	A++	
7,10	7,10	—	—	—	6,25	6,25	—	—	—	2,50	12,50	13,80	0,55	4,05	3,60	2,44	17,95	15,97	3,09	6,20	A++	
3	2,00	2,00	2,00	—	—	2,00	2,00	2,00	—	—	3,00	6,00	9,50	0,55	1,98	3,80	2,44	8,78	16,86	3,03	6,70	A++
	2,00	2,00	2,50	—	—	2,00	2,00	2,60	—	—	3,00	6,60	9,50	0,55	2,17	3,80	2,44	9,63	16,86	3,04	6,70	A++
	2,00	2,00	3,50	—	—	2,00	2,00	3,60	—	—	3,00	7,60	9,50	0,55	2,50	3,80	2,44	11,09	16,86	3,04	6,70	A++
	2,00	2,00	4,20	—	—	2,00	2,00	4,40	—	—	3,20	8,40	9,50	0,55	2,76	3,80	2,44	12,26	16,86	3,04	6,70	A++
	2,00	2,00	5,00	—	—	2,00	2,00	5,20	—	—	3,20	9,20	10,00	0,55	3,02	3,80	2,44	13,38	16,86	3,05	6,70	A++
	2,00	2,00	7,10	—	—	2,00	2,00	6,50	—	—	3,20	10,50	13,80	0,55	3,43	5,20	2,44	15,22	23,07	3,06	6,70	A++
	2,00	2,50	2,50	—	—	2,00	2,60	2,60	—	—	3,20	7,20	9,50	0,55	2,38	3,80	2,44	10,56	16,86	3,03	6,70	A++
	2,00	2,50	3,50	—	—	2,00	2,60	3,60	—	—	3,20	8,20	9,50	0,55	2,69	3,80	2,44	11,93	16,86	3,05	6,70	A++
	2,00	2,50	4,20	—	—	2,00	2,60	4,40	—	—	3,20	9,00	10,00	0,55	2,95	3,80	2,44	13,09	16,86	3,05	6,70	A++
	2,00	2,50	5,00	—	—	2,00	2,60	5,20	—	—	3,20	9,80	13,80	0,55	3,20	3,80	2,44	14,21	16,86	3,06	6,70	A++
	2,00	2,50	7,10	—	—	2,00	2,60	6,50	—	—	3,20	11,10	13,80	0,55	3,62	5,20	2,44	16,04	23,07	3,07	6,70	A++
	2,00	3,50	3,50	—	—	2,00	3,60	3,60	—	—	3,20	9,20	13,80	0,55	3,02	3,80	2,44	13,38	16,86	3,05	6,70	A++
	2,00	3,50	4,20	—	—	2,00	3,60	4,40	—	—	3,20	10,00	13,80	0,55	3,26	5,20	2,44	14,45	23,07	3,07	6,70	A++
	2,00	3,50	5,00	—	—	2,00	3,60	5,20	—	—	3,20	10,80	13,80	0,55	3,50	5,20	2,44	15,51	23,07	3,09	6,70	A++
	2,00	3,50	7,10	—	—	2,00	3,60	6,50	—	—	3,20	12,10	13,80	0,55	3,92	5,20	2,44	17,37	23,07	3,09	6,70	A++
	2,00	4,20	4,20	—	—	2,00	4,40	4,40	—	—	3,20	10,80	13,80	0,55	3,50	5,20	2,44	15,51	23,07	3,09	6,70	A++
	2,00	4,20	5,00	—	—	2,00	4,40	5,20	—	—	3,20	11,60	13,80	0,55	3,75	5,20	2,44	16,65	23,07	3,09	6,70	A++
	2,00	4,20	7,10	—	—	1,94	4,26	6,30	—	—	3,20	12,50	13,80	0,55	4,04	5,20	2,44	17,92	23,07	3,09	6,70	A++
	2,00	5,00	5,00	—	—	2,00	5,20	5,20	—	—	3,20	12,40	13,80	0,55	4,01	5,20	2,44	17,79	23,07	3,09	6,70	A++
	2,00	5,00	7,10	—	—	1,82	4,74	5,93	—	—	3,20	12,50	13,80	0,55	4,04	4,10	2,44	17,92	18,19	3,09	6,70	A++
	2,50	2,50	2,50	—	—	2,60	2,60	2,60	—	—	3,20	7,80	9,50	0,55	2,57	3,80	2,44	11,38	16,86	3,04	6,72	A++
	2,50	2,50	3,50	—	—	2,60	2,60	3,60	—	—	3,20	8,80	10,00	0,55	2,89	3,80	2,44	12,80	16,86	3,05	6,72	A++
	2,50	2,50	4,20	—	—	2,60	2,60	4,40	—	—	3,20	9,60	13,80	0,55	3,14	3,80	2,44	13,92	16,86	3,06	6,74	A++
	2,50	2,50	5,00	—	—	2,60	2,60	5,20	—	—	3,20	10,40	13,80	0,55	3,37	5,20	2,44	14,93	23,07	3,09	6,74	A++
	2,50	2,50	7,10	—	—	2,60	2,60	6,50	—	—	3,20	11,70	13,80	0,55	3,79	5,20	2,44	16,80	23,07	3,09	6,70	A++
	2,50	3,50	3,50	—	—	2,60	3,60	3,60	—	—	3,20	9,80	13,80	0,55	3,19	3,80	2,44	14,16	16,86	3,07	6,73	A++
	2,50	3,50	4,20	—	—	2,60	3,60	4,40	—	—	3,20	10,60	13,80	0,55	3,43	5,20	2,44	15,22	23,07	3,09	6,70	A++
	2,50	3,50	5,00	—	—	2,60	3,60	5,20	—	—	3,20	11,40	13,80	0,55	3,69	5,20	2,44	16,37	23,07	3,09	6,70	A++
	2,50	3,50	7,10	—	—	2,56	3,54	6,40	—	—	3,20	12,50	13,80	0,55	4,04	5,20	2,44	17,92	23,07	3,09	6,70	A++
	2,50	4,20	4,20	—	—	2,60	4,40	4,40	—	—	3,20	11,40	13,80	0,55	3,69	5,20	2,44	16,37	23,07	3,09	6,70	A++
	2,50	4,20	5,00	—	—	2,60	4,40	5,20	—	—	3,20	12,20	13,80	0,55	3,95	5,20	2,44	17,52	23,07	3,09	6,70	A++
	2,50	4,20	7,10	—	—	2,41	4,07	6,02	—	—	3,20	12,50	13,80	0,55	4,04	5,20	2,44	17,92	23,07	3,09	6,70	A++
	2,50	5,00	5,00	—	—	2,50	5,00	5,00	—	—	3,20	12,50	13,80	0,55	4,04	5,20	2,44	17,92	23,07	3,09	6,70	A++
	2,50	5,00	7,10	—	—	2,27	4,55	5,68	—	—	3,20	12,50	13,80	0,55	4,04	5,20	2,44	17,92	23,07	3,09	6,70	A++
	2,50	7,10	7,10	—	—	2,08	5,21	5,21	—	—	3,20	12,50	13,80	0,55	4,04	5,20	2,44	17,92	23,07	3,09	6,70	A++
	3,50	3,50	3,50	—	—	3,60	3,60	3,60	—	—	3,20	10,80	13,80	0,55	3,50	5,20	2,44	15,51	23,07	3,09	6,75	A++
	3,50	3,50	4,20	—	—	3,60	3,60	4,40	—	—	3,20	11,60	13,80	0,55	3,75	5,20	2,44	16,65	23,07	3,09	6,70	A++
	3,50	3,50	5,00	—	—	3,60	3,60	5,20	—	—	3,20	12,40	13,80	0,55	3,96	5,20	2,44	17,57	23,07	3,13	6,70	A++
	3,50	3,50	7,10	—	—	3,28	3,28	5,93	—	—	3,20	12,50	13,80	0,55	3,99	5,20	2,44	17,70	23,07	3,13	6,70	A++
	3,50	4,20	4,20	—	—	3,60	4,40	4,40	—	—	3,20	12,40	13,80	0,55	3,96	5,20	2,44	17,57	23,07	3,13	6,75	A++
	3,50	4,20	5,00	—	—	3,41	4,17	4,92	—	—	3,20	12,50	13,80	0,55	3,99	5,20	2,44	17,70	23,07	3,13	6,75	A++
	3,50	4,20	7,10	—	—	3,10	3,79	5,60	—	—	3,20	12,50	13,80	0,55	3,99	5,20	2,44	17,70	23,07	3,13	6,75	

# COMBINATIONS TABLE

5U125S2SN1FA Inverter (The values in the table refer to the FLEXIS series)

COOLING																						
Combinations					Output power (kW)					System output power (kW)			Absorbed power (kW)			Absorbed current (A)			EER	SEER	Energy class	
UI	A	B	C	D	E	A	B	C	D	E	min	nom	max	min	nom	max	min	nom	max			
4	2,00	2,00	2,00	2,00	—	2,00	2,00	2,00	2,00	—	3,20	8,00	13,80	0,55	2,62	4,00	2,44	11,63	17,75	3,05	6,80	A++
	2,00	2,00	2,00	2,50	—	2,00	2,00	2,00	2,60	—	3,20	8,60	13,80	0,55	2,81	4,00	2,44	12,47	17,75	3,06	6,80	A++
	2,00	2,00	2,00	3,50	—	2,00	2,00	2,00	3,60	—	3,20	9,60	13,80	0,55	3,13	4,00	2,44	13,87	17,75	3,07	6,80	A++
	2,00	2,00	2,00	4,20	—	2,00	2,00	2,00	4,40	—	3,20	10,40	13,80	0,55	3,32	5,20	2,44	14,74	23,07	3,13	6,80	A++
	2,00	2,00	2,00	5,00	—	2,00	2,00	2,00	5,20	—	3,20	11,20	13,80	0,55	3,58	5,20	2,44	15,87	23,07	3,13	6,80	A++
	2,00	2,00	2,00	7,10	—	2,00	2,00	2,00	6,50	—	3,20	12,50	13,80	0,55	3,99	4,10	2,44	17,70	18,19	3,13	6,70	A++
	2,00	2,00	2,50	2,50	—	2,00	2,00	2,60	2,60	—	3,20	9,20	13,80	0,55	3,00	4,00	2,44	13,29	17,75	3,07	6,80	A++
	2,00	2,00	2,50	3,50	—	2,00	2,00	2,60	3,60	—	3,20	10,20	13,80	0,55	3,25	5,20	2,44	14,41	23,07	3,14	6,80	A++
	2,00	2,00	2,50	4,20	—	2,00	2,00	2,60	4,40	—	3,20	11,00	13,80	0,55	3,47	5,20	2,44	15,39	23,07	3,17	6,80	A++
	2,00	2,00	2,50	5,00	—	2,00	2,00	2,60	5,20	—	3,20	11,80	13,80	0,55	3,72	5,20	2,44	16,51	23,07	3,17	6,80	A++
	2,00	2,00	2,50	7,10	—	1,91	1,91	2,48	6,20	—	3,20	12,50	13,80	0,55	3,94	5,20	2,44	17,48	23,07	3,17	6,70	A++
	2,00	2,00	3,50	3,50	—	2,00	2,00	3,60	3,60	—	3,20	11,20	13,80	0,55	3,53	5,20	2,44	15,67	23,07	3,17	6,80	A++
	2,00	2,00	3,50	4,20	—	2,00	2,00	3,60	4,40	—	3,20	12,00	13,80	0,55	3,79	5,20	2,44	16,79	23,07	3,17	6,70	A++
	2,00	2,00	3,50	5,00	—	1,95	1,95	3,52	5,08	—	3,20	12,50	13,80	0,55	3,94	5,20	2,44	17,48	23,07	3,17	6,70	A++
	2,00	2,00	3,50	7,10	—	1,77	1,77	3,19	5,76	—	3,20	12,50	13,80	0,55	3,94	5,20	2,44	17,48	23,07	3,17	6,70	A++
	2,00	2,00	4,20	4,20	—	1,95	1,95	4,30	4,30	—	3,20	12,50	13,80	0,55	3,94	5,20	2,44	17,48	23,07	3,17	6,90	A++
	2,00	2,00	4,20	5,00	—	1,84	1,84	4,04	4,78	—	3,20	12,50	13,80	0,55	3,94	5,20	2,44	17,48	23,07	3,17	6,90	A++
	2,00	2,00	4,20	7,10	—	1,68	1,68	3,69	5,45	—	3,20	12,50	13,80	0,55	3,94	5,20	2,44	17,48	23,07	3,17	6,90	A++
	2,00	2,00	5,00	5,00	—	1,74	1,74	4,51	4,51	—	3,20	12,50	13,80	0,55	3,94	5,20	2,44	17,48	23,07	3,17	6,90	A++
	2,00	2,00	5,00	7,10	—	1,59	1,59	4,14	5,18	—	3,20	12,50	13,80	0,55	3,94	5,20	2,44	17,48	23,07	3,17	6,90	A++
	2,00	2,00	7,10	7,10	—	1,47	1,47	4,78	4,78	—	3,20	12,50	13,80	0,55	3,94	5,20	2,44	17,48	23,07	3,17	6,90	A++
	2,00	2,50	2,50	2,50	—	2,00	2,60	2,60	2,60	—	3,20	9,80	13,80	0,55	3,17	4,00	2,44	14,07	17,75	3,09	6,90	A++
	2,00	2,50	2,50	3,50	—	2,00	2,60	2,60	3,60	—	3,20	10,80	13,80	0,55	3,41	5,20	2,44	15,11	23,07	3,17	6,90	A++
	2,00	2,50	2,50	4,20	—	2,00	2,60	2,60	4,40	—	3,20	11,60	13,80	0,55	3,66	5,20	2,44	16,23	23,07	3,17	6,90	A++
	2,00	2,50	2,50	5,00	—	2,00	2,60	2,60	5,20	—	3,20	12,40	13,80	0,55	3,91	5,20	2,44	17,35	23,07	3,17	6,90	A++
	2,00	2,50	2,50	7,10	—	1,82	2,37	2,37	5,93	—	3,20	12,50	13,80	0,55	3,94	5,20	2,44	17,48	23,07	3,17	6,90	A++
	2,00	2,50	3,50	3,50	—	2,00	2,60	3,60	3,60	—	3,20	11,80	13,80	0,55	3,70	5,20	2,44	16,41	23,07	3,19	6,90	A++
	2,00	2,50	3,50	4,20	—	1,98	2,58	3,57	4,37	—	3,20	12,50	13,80	0,55	3,92	5,20	2,44	17,39	23,07	3,19	6,90	A++
	2,00	2,50	3,50	5,00	—	1,87	2,43	3,36	4,85	—	3,20	12,50	13,80	0,55	3,92	5,20	2,44	17,39	23,07	3,19	6,90	A++
	2,00	2,50	3,50	7,10	—	1,70	2,21	3,06	5,53	—	3,20	12,50	13,80	0,55	3,92	5,20	2,44	17,39	23,07	3,19	6,90	A++
	2,00	2,50	4,20	4,20	—	1,87	2,43	4,10	4,10	—	3,20	12,50	13,80	0,55	3,92	5,20	2,44	17,39	23,07	3,19	6,90	A++
	2,00	2,50	4,20	5,00	—	1,76	2,29	3,87	4,58	—	3,20	12,50	13,80	0,55	3,92	5,20	2,44	17,39	23,07	3,19	6,90	A++
	2,00	2,50	4,20	7,10	—	1,61	2,10	3,55	5,24	—	3,20	12,50	13,80	0,55	3,92	5,20	2,44	17,39	23,07	3,19	6,90	A++
	2,00	2,50	5,00	5,00	—	1,67	2,17	4,33	4,33	—	3,20	12,50	13,80	0,55	3,92	5,20	2,44	17,39	23,07	3,19	6,90	A++
	2,00	2,50	5,00	7,10	—	1,53	1,99	3,99	4,98	—	3,20	12,50	13,80	0,55	3,92	5,20	2,44	17,39	23,07	3,19	6,90	A++
	2,00	2,50	7,10	7,10	—	1,42	1,85	4,62	4,62	—	3,20	12,50	13,80	0,55	3,92	5,20	2,44	17,39	23,07	3,19	6,90	A++
	2,00	3,50	3,50	3,50	—	1,95	3,52	3,52	3,52	—	3,20	12,50	13,80	0,55	3,92	5,20	2,44	17,39	23,07	3,19	6,90	A++
	2,00	3,50	3,50	4,20	—	1,84	3,31	3,31	4,04	—	3,20	12,50	13,80	0,55	3,92	5,20	2,44	17,39	23,07	3,19	6,90	A++
	2,00	3,50	3,50	5,00	—	1,74	3,13	3,13	4,51	—	3,20	12,50	13,80	0,55	3,90	5,20	2,44	17,30	23,07	3,21	6,90	A++
	2,00	3,50	3,50	7,10	—	1,59	2,87	2,87	5,18	—	3,20	12,50	13,80	0,55	3,90	5,20	2,44	17,30	23,07	3,21	6,90	A++
	2,00	3,50	4,20	4,20	—	1,74	3,13	3,82	3,82	—	3,20	12,50	13,80	0,55	3,90	5,20	2,44	17,30	23,07	3,21	6,90	A++
	2,00	3,50	4,20	5,00	—	1,64	2,96	3,62	4,28	—	3,20	12,50	13,80	0,55	3,90	5,20	2,44	17,30	23,07	3,21	6,90	A++
	2,00	3,50	4,20	7,10	—	1,52	2,73	3,33	4,92	—	3,20	12,50	13,80	0,55	3,90	5,20	2,44	17,30	23,07	3,21	6,90	A++
	2,00	4,20	4,20	4,20	—	1,64	3,62	3,62	3,62	—	3,20	12,50	13,80	0,55	3,90	5,20	2,44	17,30	23,07	3,21	6,90	A++
	2,00	4,20	4,20	5,00	—	1,56	3,44	3,44	4,06	—	3,20	12,50	13,80	0,55	3,90	5,20	2,44	17,30	23,07	3,21	6,90	A++
2,00	4,20	4,20	7,10	—	1,45	3,18	3,18	4,70	—	3,20	12,50	13,80	0,55	3,90	5,20	2,44	17,30	23,07	3,21	6,90	A++	
2,00	5,00	5,00	5,00	—	1,42	3,69	3,69	3,69	—	3,20	12,50	13,80	0,55	3,90	5,20	2,44	17,30	23,07	3,21	6,90	A++	
2,50	2,50	2,50	2,50	—	2,60	2,60	2,60	2,60	—	3,20	10,40	13,80	0,55	3,24	5,20	2,44	14,37	23,07	3,21	6,90	A++	
2,50	2,50	2,50	3,50	—	2,60	2,60	2,60	3,60	—	3,20	11,40	13,80	0,55	3,55	5,20	2,44	15,75	23,07	3,21	6,90	A++	
2,50	2,50	2,50	4,20	—	2,60	2,60	2,60	4,40	—	3,20	12,20	13,80	0,55	3,80	5,20	2,44	16,86	23,07	3,21	6,90	A++	
2,50	2,50	2,50	5,00	—	2,50	2,50	2,50	5,00	—	3,20	12,50	13,80	0,55	3,90	5,20	2,44	17,30	23,07	3,21	6,90	A++	
2,50	2,50	2,50	7,10	—	2,27	2,27	2,27	5,68	—	3,20	12,50	13,80	0,55	3,90	5,20	2,44	17,30	23,07	3,21	6,90	A++	
2,50	2,50	3,50	3,50	—	2,60	2,60	3,60	3,60	—	3,20	12,40	13,80	0,55	3,86	5,20	2,44	17,13	23,07	3,21	6,90	A++	
2,50	2,50	3,50	4,20	—	2,46	2,46	3,41	4,17	—	3,20	12,50	13,80	0,55	3,90	5,20	2,44	17,30	23,07	3,21	7,10	A++	
2,50	2,50	3,50	5,00	—	2,32	2,32	3,21	4,64	—	3,20	12,50	13,80	0,55	3,90	5,20	2,44	17,30	23,07	3,21	7,10	A++	
2,50	2,50	3,50	7,10	—	2,12	2,12	2,94	5,31	—	3,20	12,50	13,80	0,55	3,90	5,20	2,44	17,30	23,07	3,21	7,10	A++	
2,50	2,50	4,20	4,20	—	2,32	2,32	3,93	3,93	—	3,20	12,50	13,80	0,55	3,90	5,20	2,44	17,30	23,07	3,21	7,10	A++	
2,50	2,50	4,20	5,00	—	2,20	2,20	3,72	4,39	—	3,20	12,50	13,80	0,55	3,89	5,20	2,44	17,26	23,07	3,21	7,10	A++	
2,50	2,50	4,20	7,10	—	2,02	2,02	3,42	5,05	—	3,20	12,50	13,80	0,55	3,87	5,20	2,44	17,17	23,07	3,23	7,10	A++	
2,50	2,50	5,00	5,00	—	2,08	2,08	4,17	4,17	—	3,20	12,50	13,80	0,55	3,87	5,20	2,44	17,17	23,07	3,23	7,10	A++	
2,5																						

5U125S2SN1FA Inverter (The values in the table refer to the FLEXIS series)

COOLING																						
Combinations					Output power (kW)					System output power (kW)			Absorbed power (kW)			Absorbed current (A)			EER	SEER	Energy class	
UI	A	B	C	D	E	A	B	C	D	E	min	nom	max	min	nom	max	min	nom	max			
5	2,00	2,00	2,00	2,00	2,00	2,00	2,00	2,00	2,00	2,00	3,20	10,00	13,80	0,55	3,10	5,20	2,44	13,75	23,07	3,23	7,10	A++
	2,00	2,00	2,00	2,00	2,50	2,00	2,00	2,00	2,00	2,60	3,20	10,60	13,80	0,55	3,28	5,20	2,44	14,56	23,07	3,23	7,10	A++
	2,00	2,00	2,00	2,00	3,50	2,00	2,00	2,00	2,00	3,60	3,20	11,60	13,80	0,55	3,59	5,20	2,44	15,93	23,07	3,23	7,10	A++
	2,00	2,00	2,00	2,00	4,20	2,00	2,00	2,00	2,00	4,40	3,20	12,40	13,80	0,55	3,84	5,20	2,44	17,03	23,07	3,23	7,10	A++
	2,00	2,00	2,00	2,00	5,00	1,89	1,89	1,89	1,89	4,92	3,20	12,50	13,80	0,55	3,87	5,20	2,44	17,17	23,07	3,23	7,10	A++
	2,00	2,00	2,00	2,00	7,10	1,72	1,72	1,72	1,72	5,60	3,20	12,50	13,80	0,55	3,87	5,20	2,44	17,17	23,07	3,23	7,10	A++
	2,00	2,00	2,00	2,50	2,50	2,00	2,00	2,00	2,60	2,60	3,20	11,20	13,80	0,55	3,47	5,20	2,44	15,38	23,07	3,23	7,10	A++
	2,00	2,00	2,00	2,50	3,50	2,00	2,00	2,00	2,60	3,60	3,20	12,20	13,80	0,55	3,78	5,20	2,44	16,76	23,07	3,23	7,10	A++
	2,00	2,00	2,00	2,50	4,20	1,92	1,92	1,92	2,50	4,23	3,20	12,50	13,80	0,55	3,87	5,20	2,44	17,17	23,07	3,23	7,10	A++
	2,00	2,00	2,00	2,50	5,00	1,81	1,81	1,81	2,36	4,71	3,20	12,50	13,80	0,55	3,87	5,20	2,44	17,17	23,07	3,23	7,10	A++
	2,00	2,00	2,00	2,50	7,10	1,66	1,66	1,66	2,15	5,38	3,20	12,50	13,80	0,55	3,87	5,20	2,44	17,17	23,07	3,23	7,10	A++
	2,00	2,00	2,00	3,50	3,50	1,89	1,89	1,89	3,41	3,41	3,20	12,50	13,80	0,55	3,87	5,20	2,44	17,17	23,07	3,23	7,10	A++
	2,00	2,00	2,00	3,50	4,20	1,79	1,79	1,79	3,21	3,93	3,20	12,50	13,80	0,55	3,87	5,20	2,44	17,17	23,07	3,23	7,10	A++
	2,00	2,00	2,00	3,50	5,00	1,69	1,69	1,69	3,04	4,39	3,20	12,50	13,80	0,55	3,87	5,20	2,44	17,17	23,07	3,23	7,10	A++
	2,00	2,00	2,00	3,50	7,10	1,55	1,55	1,55	2,80	5,05	3,20	12,50	13,80	0,55	3,87	5,20	2,44	17,17	23,07	3,23	7,10	A++
	2,00	2,00	2,00	4,20	4,20	1,69	1,69	1,69	3,72	3,72	3,20	12,50	13,80	0,55	3,87	5,20	2,44	17,17	23,07	3,23	7,10	A++
	2,00	2,00	2,00	4,20	5,00	1,60	1,60	1,60	3,53	4,17	3,20	12,50	13,80	0,55	3,87	5,20	2,44	17,17	23,07	3,23	7,10	A++
	2,00	2,00	2,00	4,20	7,10	1,48	1,48	1,48	3,25	4,81	3,20	12,50	13,80	0,55	3,87	5,20	2,44	17,17	23,07	3,23	7,10	A++
	2,00	2,00	2,50	2,50	2,50	2,00	2,00	2,60	2,60	2,60	3,20	11,80	13,80	0,55	3,65	5,20	2,44	16,21	23,07	3,23	7,10	A++
	2,00	2,00	2,50	2,50	3,50	1,95	1,95	2,54	2,54	3,52	3,20	12,50	13,80	0,55	3,87	5,20	2,44	17,17	23,07	3,23	7,10	A++
	2,00	2,00	2,50	2,50	4,20	1,84	1,84	2,39	2,39	4,04	3,20	12,50	13,80	0,55	3,87	5,20	2,44	17,17	23,07	3,23	7,10	A++
	2,00	2,00	2,50	2,50	5,00	1,74	1,74	2,26	2,26	4,51	3,20	12,50	13,80	0,55	3,87	5,20	2,44	17,17	23,07	3,23	7,10	A++
	2,00	2,00	2,50	2,50	7,10	1,59	1,59	2,07	2,07	5,18	3,20	12,50	13,80	0,55	3,87	5,20	2,44	17,17	23,07	3,23	7,10	A++
	2,00	2,00	2,50	3,50	3,50	1,81	1,81	2,36	3,26	3,26	3,20	12,50	13,80	0,55	3,87	5,20	2,44	17,17	23,07	3,23	7,10	A++
	2,00	2,00	2,50	3,50	4,20	1,71	1,71	2,23	3,08	3,77	3,20	12,50	13,80	0,55	3,87	5,20	2,44	17,17	23,07	3,23	7,10	A++
	2,00	2,00	2,50	3,50	5,00	1,62	1,62	2,11	2,92	4,22	3,20	12,50	13,80	0,55	3,87	5,20	2,44	17,17	23,07	3,23	7,10	A++
	2,00	2,00	2,50	3,50	7,10	1,50	1,50	1,95	2,69	4,87	3,20	12,50	13,80	0,55	3,87	5,20	2,44	17,17	23,07	3,23	7,10	A++
	2,00	2,00	2,50	4,20	4,20	1,62	1,62	2,11	3,57	3,57	3,20	12,50	13,80	0,55	3,87	5,20	2,44	17,17	23,07	3,23	7,10	A++
	2,00	2,00	2,50	4,20	5,00	1,54	1,54	2,01	3,40	4,01	3,20	12,50	13,80	0,55	3,87	5,20	2,44	17,17	23,07	3,23	7,10	A++
	2,00	2,00	2,50	4,20	7,10	1,43	1,43	1,86	3,14	4,64	3,20	12,50	13,80	0,55	3,87	5,20	2,44	17,17	23,07	3,23	7,10	A++
	2,00	2,00	3,50	3,50	3,50	1,69	1,69	3,04	3,04	3,04	3,20	12,50	13,80	0,55	3,87	5,20	2,44	17,17	23,07	3,23	7,10	A++
	2,00	2,00	3,50	3,50	4,20	1,60	1,60	2,88	2,88	3,53	3,20	12,50	13,80	0,55	3,87	5,20	2,44	17,17	23,07	3,23	7,10	A++
	2,00	2,00	3,50	3,50	5,00	1,52	1,52	2,74	2,74	3,96	3,20	12,50	13,80	0,55	3,87	5,20	2,44	17,17	23,07	3,23	7,10	A++
	2,00	2,00	3,50	3,50	7,10	1,41	1,41	2,54	2,54	4,59	3,20	12,50	13,80	0,55	3,87	5,20	2,44	17,17	23,07	3,23	7,10	A++
	2,00	2,50	2,50	2,50	2,50	2,00	2,60	2,60	2,60	2,60	3,20	12,40	13,80	0,55	3,84	5,20	2,44	17,04	23,07	3,23	7,10	A++
	2,00	2,50	2,50	2,50	3,50	1,87	2,43	2,43	2,43	3,36	3,20	12,50	13,80	0,55	3,87	5,20	2,44	17,17	23,07	3,23	7,10	A++
	2,00	2,50	2,50	2,50	4,20	1,76	2,29	2,29	2,29	3,87	3,20	12,50	13,80	0,55	3,87	5,20	2,44	17,17	23,07	3,23	7,10	A++
	2,00	2,50	2,50	2,50	5,00	1,67	2,17	2,17	2,17	4,33	3,20	12,50	13,80	0,55	3,87	5,20	2,44	17,17	23,07	3,23	7,10	A++
	2,00	2,50	2,50	2,50	7,10	1,53	1,99	1,99	1,99	4,98	3,20	12,50	13,80	0,55	3,87	5,20	2,44	17,17	23,07	3,23	7,10	A++
	2,00	2,50	2,50	3,50	3,50	1,74	2,26	2,26	3,13	3,13	3,20	12,50	13,80	0,55	3,87	5,20	2,44	17,17	23,07	3,23	7,10	A++
	2,00	2,50	2,50	3,50	4,20	1,64	2,14	2,14	2,96	3,62	3,20	12,50	13,80	0,55	3,87	5,20	2,44	17,17	23,07	3,23	7,10	A++
	2,00	2,50	2,50	3,50	5,00	1,56	2,03	2,03	2,81	4,06	3,20	12,50	13,80	0,55	3,87	5,20	2,44	17,17	23,07	3,23	7,10	A++
	2,00	2,50	2,50	3,50	7,10	1,45	1,88	1,88	2,60	4,70	3,20	12,50	13,80	0,55	3,87	5,20	2,44	17,17	23,07	3,23	7,10	A++
	2,00	2,50	3,50	3,50	3,50	1,62	2,11	2,92	2,92	3,92	3,20	12,50	13,80	0,55	3,87	5,20	2,44	17,17	23,07	3,23	7,10	A++
	2,00	2,50	3,50	3,50	4,20	1,54	2,01	2,78	2,78	4,40	3,20	12,50	13,80	0,55	3,87	5,20	2,44	17,17	23,07	3,23	7,10	A++
	2,00	2,50	3,50	3,50	5,00	1,47	1,91	2,65	2,65	3,82	3,20	12,50	13,80	0,55	3,87	5,20	2,44	17,17	23,07	3,23	7,10	A++
	2,00	2,50	3,50	3,50	7,10	1,37	1,78	2,46	2,46	4,44	3,20	12,50	13,80	0,55	3,87	5,20	2,44	17,17	23,07	3,23	7,10	A++
	2,50	2,50	2,50	2,50	2,50	2,50	2,50	2,50	2,50	2,50	3,20	12,50	13,80	0,55	3,87	5,20	2,44	17,17	23,07	3,23	7,10	A++
2,50	2,50	2,50	2,50	3,50	2,32	2,32	2,32	2,32	3,21	3,20	12,50	13,80	0,55	3,87	5,20	2,44	17,17	23,07	3,23	7,10	A++	
2,50	2,50	2,50	2,50	4,20	2,20	2,20	2,20	2,20	3,72	3,20	12,50	13,80	0,55	3,87	5,20	2,44	17,17	23,07	3,23	7,10	A++	
2,50	2,50	2,50	2,50	5,00	2,08	2,08	2,08	2,08	4,17	3,20	12,50	13,80	0,55	3,87	5,20	2,44	17,17	23,07	3,23	7,10	A++	
2,50	2,50	2,50	2,50	7,10	1,92	1,92	1,92	1,92	4,81	3,20	12,50	13,80	0,55	3,87	5,20	2,44	17,17	23,07	3,23	7,10	A++	
2,50	2,50	2,50	3,50	3,50	2,17	2,17	2,17	3,00	3,00	3,20	12,50	13,80	0,55	3,87	5,20	2,44	17,17	23,07	3,23	7,10	A++	
2,50	2,50	2,50	3,50	4,20	2,06	2,06	2,06	2,85	3,48	3,20	12,50	13,80	0,55	3,87	5,20	2,44	17,17	23,07	3,23	7,10	A++	
2,50	2,50	2,50	3,50	5,00	1,96	1,96	1,96	2,71	3,92	3,20	12,50	13,80	0,55	3,87	5,20	2,44	17,17	23,07	3,23	7,10	A++	
2,50	2,50	2,50	3,50	7,10	1,82	1,82	1,82	2,51	4,54	3,20	12,50	13,80	0,55	3,87	5,20	2,44	17,17	23,07	3,23	7,10	A++	
2,50	2,50	2,50	4,20	4,20	1,96	1,96	1,96	3,31	3,31	3,20	12,50	13,80	0,55	3,87	5,20	2,44	17,17	23,07	3,23	7,10	A++	
2,50	2,50	2,50	4,20	5,00	1,87	1,87	1,87	3,16	3,74	3,20	12,50	13,80	0,55	3,87	5,20	2,44	17,17	23,07	3,23	7,10	A++	
2,50	2,50	2,50	5,00	5,00	1,79	1,79	1,79	3,57														

# COMBINATIONS TABLE

5U125S2SN1FA Inverter (The values in the table refer to the FLEXIS series)

HEATING																						
Combinations					Output power (kW)					System output power (kW)			Absorbed power (kW)			Absorbed current (A)			COP	SCOP	Energy class	
UI	A	B	C	D	E	A	B	C	D	E	min	nom	max	min	nom	max	min	nom	max			
2	2,00	2,00	—	—	—	2,30	2,30	—	—	—	2,80	4,60	10,00	0,55	1,33	4,10	2,44	5,88	18,19	3,47	3,80	A
	2,00	2,50	—	—	—	2,30	3,60	—	—	—	3,00	5,90	12,40	0,55	1,70	4,10	2,44	7,52	18,19	3,48	3,80	A
	2,00	3,50	—	—	—	2,30	4,50	—	—	—	3,20	6,80	12,40	0,55	1,94	4,10	2,44	8,59	18,19	3,51	3,80	A
	2,00	4,20	—	—	—	2,30	5,40	—	—	—	3,40	7,70	12,40	0,55	2,19	4,10	2,44	9,73	18,19	3,51	3,85	A
	2,00	5,00	—	—	—	2,30	6,00	—	—	—	3,80	8,30	14,30	0,55	2,34	4,10	2,44	10,37	18,19	3,55	3,85	A
	2,00	7,10	—	—	—	2,30	7,00	—	—	—	4,00	9,30	14,30	0,55	2,60	4,10	2,44	11,52	18,19	3,58	3,90	A
	2,50	2,50	—	—	—	3,60	3,60	—	—	—	3,40	7,20	13,00	0,55	2,06	4,10	2,44	9,15	18,19	3,49	3,90	A
	2,50	3,50	—	—	—	3,60	4,50	—	—	—	3,80	8,10	13,00	0,55	2,31	4,10	2,44	10,24	18,19	3,51	3,88	A
	2,50	4,20	—	—	—	3,60	5,40	—	—	—	4,00	9,00	13,00	0,55	2,55	4,10	2,44	11,31	18,19	3,53	3,92	A
	2,50	5,00	—	—	—	3,60	6,00	—	—	—	4,40	9,60	13,00	0,55	2,69	4,10	2,44	11,93	18,19	3,57	3,90	A
	2,50	7,10	—	—	—	3,60	7,00	—	—	—	4,40	10,60	13,50	0,55	2,94	4,10	2,44	13,03	18,19	3,61	3,89	A
	3,50	3,50	—	—	—	4,50	4,50	—	—	—	4,00	9,00	13,00	0,55	2,55	4,10	2,44	11,31	18,19	3,53	3,91	A
	3,50	4,20	—	—	—	4,50	5,40	—	—	—	4,40	9,90	13,00	0,55	2,79	4,10	2,44	12,37	18,19	3,55	3,87	A
	3,50	5,00	—	—	—	4,50	6,00	—	—	—	4,40	10,50	14,30	0,55	2,92	4,10	2,44	12,97	18,19	3,59	3,85	A
	3,50	7,10	—	—	—	4,50	7,00	—	—	—	4,40	11,50	14,30	0,55	3,19	4,10	2,44	14,13	18,19	3,61	3,89	A
	4,20	4,20	—	—	—	5,40	5,40	—	—	—	4,40	10,80	14,30	0,55	3,03	4,10	2,44	13,42	18,19	3,57	3,91	A
	4,20	5,00	—	—	—	5,40	6,00	—	—	—	4,40	11,40	14,30	0,55	3,16	4,10	2,44	14,01	18,19	3,61	3,88	A
	4,20	7,10	—	—	—	5,40	7,00	—	—	—	4,40	12,40	14,30	0,55	3,43	4,10	2,44	15,20	18,19	3,62	3,91	A
	5,00	5,00	—	—	—	6,00	6,00	—	—	—	4,40	12,00	14,30	0,55	3,31	4,10	2,44	14,66	18,19	3,63	3,85	A
	5,00	7,10	—	—	—	5,86	6,84	—	—	—	4,40	12,70	14,30	0,55	3,49	4,10	2,44	15,48	18,19	3,64	3,92	A
7,10	7,10	—	—	—	6,35	6,35	—	—	—	4,40	12,70	14,30	0,55	3,48	4,10	2,44	15,43	18,19	3,65	3,90	A	
3	2,00	2,00	2,00	—	—	2,30	2,30	2,30	—	—	3,80	6,90	14,30	0,55	1,98	4,30	2,44	8,79	19,08	3,48	3,80	A
	2,00	2,00	2,50	—	—	2,30	2,30	3,60	—	—	4,00	8,20	14,30	0,55	2,34	4,30	2,44	10,39	19,08	3,50	3,85	A
	2,00	2,00	3,50	—	—	2,30	2,30	4,50	—	—	4,20	9,10	14,30	0,55	2,59	4,30	2,44	11,47	19,08	3,52	3,85	A
	2,00	2,00	4,20	—	—	2,30	2,30	5,40	—	—	4,40	10,00	14,30	0,55	2,81	4,30	2,44	12,46	19,08	3,56	3,85	A
	2,00	2,00	5,00	—	—	2,30	2,30	6,00	—	—	4,40	10,60	14,30	0,55	2,98	4,30	2,44	13,21	19,08	3,56	3,85	A
	2,00	2,00	7,10	—	—	2,30	2,30	7,00	—	—	4,40	11,60	14,30	0,55	3,26	4,30	2,44	14,45	19,08	3,56	3,85	A
	2,00	2,50	2,50	—	—	2,30	3,60	3,60	—	—	4,40	9,50	14,30	0,55	2,70	4,30	2,44	11,97	19,08	3,52	3,85	A
	2,00	2,50	3,50	—	—	2,30	3,60	4,50	—	—	4,40	10,40	14,30	0,55	2,95	4,30	2,44	13,11	19,08	3,52	3,85	A
	2,00	2,50	4,20	—	—	2,30	3,60	5,40	—	—	4,40	11,30	14,30	0,55	3,17	4,30	2,44	14,08	19,08	3,56	3,85	A
	2,00	2,50	5,00	—	—	2,30	3,60	6,00	—	—	4,40	11,90	14,30	0,55	3,34	4,30	2,44	14,83	19,08	3,56	3,87	A
	2,00	2,50	7,10	—	—	2,26	3,54	6,89	—	—	4,40	12,70	14,30	0,55	3,57	4,30	2,44	15,83	19,08	3,56	3,87	A
	2,00	3,50	3,50	—	—	2,30	4,50	4,50	—	—	4,40	11,30	14,30	0,55	3,17	4,30	2,44	14,08	19,08	3,56	3,87	A
	2,00	3,50	4,20	—	—	2,30	4,50	5,40	—	—	4,40	12,20	14,30	0,55	3,43	4,30	2,44	15,20	19,08	3,56	3,87	A
	2,00	3,50	5,00	—	—	2,28	4,46	5,95	—	—	4,40	12,70	14,30	0,55	3,57	4,30	2,44	15,83	19,08	3,56	3,87	A
	2,00	3,50	7,10	—	—	2,12	4,14	6,44	—	—	4,40	12,70	14,30	0,55	3,55	4,30	2,44	15,74	19,08	3,58	3,87	A
	2,00	4,20	4,20	—	—	2,23	5,24	5,24	—	—	4,40	12,70	14,30	0,55	3,55	4,30	2,44	15,74	19,08	3,58	3,87	A
	2,00	4,20	5,00	—	—	2,13	5,01	5,56	—	—	4,40	12,70	14,30	0,55	3,55	4,30	2,44	15,74	19,08	3,58	3,87	A
	2,00	4,20	7,10	—	—	1,99	4,67	6,05	—	—	4,40	12,70	14,30	0,55	3,55	4,30	2,44	15,74	19,08	3,58	3,92	A
	2,00	5,00	5,00	—	—	2,04	5,33	5,33	—	—	4,40	12,70	14,30	0,55	3,55	4,30	2,44	15,74	19,08	3,58	3,92	A
	2,00	5,00	7,10	—	—	1,91	4,98	5,81	—	—	4,40	12,70	14,30	0,55	3,55	4,30	2,44	15,74	19,08	3,58	3,92	A
	2,50	2,50	2,50	—	—	3,60	3,60	3,60	—	—	4,40	10,80	14,30	0,55	3,01	4,30	2,44	13,35	19,08	3,59	3,92	A
	2,50	2,50	3,50	—	—	3,60	3,60	4,50	—	—	4,40	11,70	14,30	0,55	3,26	4,30	2,44	14,46	19,08	3,59	3,92	A
	2,50	2,50	4,20	—	—	3,60	3,60	5,40	—	—	4,40	12,60	14,30	0,55	3,51	4,30	2,44	15,57	19,08	3,59	3,92	A
	2,50	2,50	5,00	—	—	3,46	3,46	5,77	—	—	4,40	12,70	14,30	0,55	3,54	4,30	2,44	15,69	19,08	3,59	3,92	A
	2,50	2,50	7,10	—	—	3,22	3,22	6,26	—	—	4,40	12,70	14,30	0,55	3,54	4,30	2,44	15,69	19,08	3,59	3,95	A
	2,50	3,50	3,50	—	—	3,60	4,50	4,50	—	—	4,40	12,60	14,30	0,55	3,51	4,30	2,44	15,57	19,08	3,59	3,90	A
	2,50	3,50	4,20	—	—	3,39	4,23	5,08	—	—	4,40	12,70	14,30	0,55	3,54	4,30	2,44	15,69	19,08	3,59	3,90	A
	2,50	3,50	5,00	—	—	3,24	4,05	5,40	—	—	4,40	12,70	14,30	0,55	3,54	4,30	2,44	15,69	19,08	3,59	3,90	A
	2,50	3,50	7,10	—	—	3,03	3,78	5,89	—	—	4,40	12,70	14,30	0,55	3,54	4,30	2,44	15,69	19,08	3,59	3,90	A
	2,50	4,20	4,20	—	—	3,18	4,76	4,76	—	—	4,40	12,70	14,30	0,55	3,54	4,30	2,44	15,69	19,08	3,59	3,90	A
	2,50	4,20	5,00	—	—	3,05	4,57	5,08	—	—	4,40	12,70	14,30	0,55	3,54	4,30	2,44	15,69	19,08	3,59	3,90	A
	2,50	4,20	7,10	—	—	2,86	4,29	5,56	—	—	4,40	12,70	14,30	0,55	3,54	4,30	2,44	15,69	19,08	3,59	3,90	A
	2,50	5,00	5,00	—	—	2,93	4,88	4,88	—	—	4,40	12,70	14,30	0,55	3,54	4,30	2,44	15,69	19,08	3,59	3,90	A
	2,50	5,00	7,10	—	—	2,75	4,59	5,36	—	—	4,40	12,70	14,30	0,55	3,54	4,30	2,44	15,69	19,08	3,59	3,90	A
	2,50	7,10	7,10	—	—	2,60	5,05	5,05	—	—	4,40	12,70	14,30	0,55	3,54	4,30	2,44	15,69	19,08	3,59	3,90	A
	3,50	3,50	3,50	—	—	4,23	4,23	4,23	—	—	4,40	12,70	14,30	0,55	3,54	4,30	2,44	15,69	19,08	3,59	3,95	A
	3,50	3,50	4,20	—	—	3,97	3,97	4,76	—	—	4,40	12,70	14,30	0,55	3,54	4,30	2,44	15,69	19,08	3,59	3,95	A
	3,50	3,50	5,00	—	—	3,81	3,81	5,08	—	—	4,40	12,70	14,30	0,55	3,51	4,30	2,44	15,56	19,08	3,62	3,95	A
	3,50	3,50	7,10	—	—	3,57	3,57	5,56	—	—	4,40	12,70	14,30	0,55	3,51	4,30	2,44	15,56	19,08	3,62	3,90	A
	3,50	4,20	4,20	—	—	3,74	4,48	4,48	—	—	4,40	12,70	14,30	0,55	3,51	4,30	2,44	15,56	19,08	3,62	3,95	A
3,50	4,20	5,00	—	—	3,59	4,31	4,79	—	—	4,40	12,70	14,30	0,55	3,51	4,30	2,44	15,56	19,08	3,62	3,95	A	
3,50	4,20	7,10	—	—	3,38	4,06	5,26	—	—	4,40	12,70	14,30	0,55	3,49	4,30	2,44	15,48	19,08	3,64	3,9		

5U125S2SN1FA Inverter (The values in the table refer to the FLEXIS series)

HEATING																							
Combinations					Output power (kW)					System output power (kW)			Absorbed power (kW)			Absorbed current (A)			COP	SCOP	Energy class		
UI	A	B	C	D	E	A	B	C	D	E	min	nom	max	min	nom	max	min	nom	max	max			
4	2,00	2,00	2,00	2,00	—	2,30	2,30	2,30	2,30	—	4,20	9,20	14,30	0,55	2,56	4,30	2,44	11,37	19,08	3,59	3,90	A	
	2,00	2,00	2,00	2,50	—	2,30	2,30	2,30	3,60	—	4,20	10,50	14,30	0,55	2,92	4,30	2,44	12,94	19,08	3,60	3,90	A	
	2,00	2,00	2,00	3,50	—	2,30	2,30	2,30	4,50	—	4,40	11,40	14,30	0,55	3,17	4,30	2,44	14,05	19,08	3,60	3,90	A	
	2,00	2,00	2,00	4,20	—	2,30	2,30	2,30	5,40	—	4,40	12,30	14,30	0,55	3,42	4,30	2,44	15,16	19,08	3,60	3,90	A	
	2,00	2,00	2,00	5,00	—	2,26	2,26	2,26	5,91	—	4,40	12,70	14,30	0,55	3,53	4,30	2,44	15,65	19,08	3,60	3,90	A	
	2,00	2,00	2,00	7,10	—	2,10	2,10	2,10	6,40	—	4,40	12,70	14,30	0,55	3,53	4,30	2,44	15,65	19,08	3,60	3,90	A	
	2,00	2,00	2,50	2,50	—	2,30	2,30	3,60	3,60	—	4,40	11,80	14,30	0,55	3,28	4,30	2,44	14,54	19,08	3,60	3,90	A	
	2,00	2,00	2,50	3,50	—	2,30	2,30	3,60	4,50	—	4,40	12,70	14,30	0,55	3,51	4,30	2,44	15,56	19,08	3,62	3,90	A	
	2,00	2,00	2,50	4,20	—	2,15	2,15	3,36	5,04	—	4,40	12,70	14,30	0,55	3,51	4,30	2,44	15,56	19,08	3,62	3,95	A	
	2,00	2,00	2,50	5,00	—	2,06	2,06	3,22	5,37	—	4,40	12,70	14,30	0,55	3,51	4,30	2,44	15,56	19,08	3,62	3,95	A	
	2,00	2,00	2,50	7,10	—	1,92	1,92	3,01	5,85	—	4,40	12,70	14,30	0,55	3,51	4,30	2,44	15,56	19,08	3,62	3,95	A	
	2,00	2,00	3,50	3,50	—	2,15	2,15	4,20	4,20	—	4,40	12,70	14,30	0,55	3,51	4,30	2,44	15,56	19,08	3,62	3,95	A	
	2,00	2,00	3,50	4,20	—	2,01	2,01	3,94	4,73	—	4,40	12,70	14,30	0,55	3,51	4,30	2,44	15,56	19,08	3,62	3,95	A	
	2,00	2,00	3,50	5,00	—	1,93	1,93	3,78	5,05	—	4,40	12,70	14,30	0,55	3,48	4,30	2,44	15,43	19,08	3,65	3,95	A	
	2,00	2,00	3,50	7,10	—	1,81	1,81	3,55	5,52	—	4,40	12,70	14,30	0,55	3,48	4,30	2,44	15,43	19,08	3,65	3,95	A	
	2,00	2,00	4,20	4,20	—	1,90	1,90	4,45	4,45	—	4,40	12,70	14,30	0,55	3,48	4,30	2,44	15,43	19,08	3,65	3,95	A	
	2,00	2,00	4,20	5,00	—	1,83	1,83	4,29	4,76	—	4,40	12,70	14,30	0,55	3,48	4,30	2,44	15,43	19,08	3,65	3,95	A	
	2,00	2,00	4,20	7,10	—	1,72	1,72	4,03	5,23	—	4,40	12,70	14,30	0,55	3,48	4,30	2,44	15,43	19,08	3,65	3,95	A	
	2,00	2,00	5,00	5,00	—	1,76	1,76	4,59	4,59	—	4,40	12,70	14,30	0,55	3,48	4,30	2,44	15,43	19,08	3,65	3,95	A	
	2,00	2,00	5,00	7,10	—	1,66	1,66	4,33	5,05	—	4,40	12,70	14,30	0,55	3,48	4,30	2,44	15,43	19,08	3,65	3,95	A	
	2,00	2,00	7,10	7,10	—	1,57	1,57	4,78	4,78	—	4,40	12,70	14,30	0,55	3,48	4,30	2,44	15,43	19,08	3,65	3,95	A	
	2,00	2,50	2,50	2,50	—	2,23	3,49	3,49	3,49	—	4,40	12,70	14,30	0,55	3,48	4,30	2,44	15,43	19,08	3,65	3,95	A	
	2,00	2,50	2,50	3,50	—	2,09	3,27	3,27	4,08	—	4,40	12,70	14,30	0,55	3,43	4,30	2,44	15,23	19,08	3,70	3,95	A	
	2,00	2,50	2,50	4,20	—	1,96	3,07	3,07	4,60	—	4,40	12,70	14,30	0,55	3,43	4,30	2,44	15,23	19,08	3,70	4,00	A	
	2,00	2,50	2,50	5,00	—	1,88	2,95	2,95	4,92	—	4,40	12,70	14,30	0,55	3,43	4,30	2,44	15,23	19,08	3,70	4,00	A	
	2,00	2,50	2,50	7,10	—	1,77	2,77	2,77	5,39	—	4,40	12,70	14,30	0,55	3,43	4,30	2,44	15,23	19,08	3,70	4,00	A	
	2,00	2,50	3,50	3,50	—	1,96	3,07	3,84	3,84	—	4,40	12,70	14,30	0,55	3,43	4,30	2,44	15,23	19,08	3,70	4,00	A	
	2,00	2,50	3,50	4,20	—	1,85	2,89	3,62	4,34	—	4,40	12,70	14,30	0,55	3,43	4,30	2,44	15,23	19,08	3,70	4,00	A	
	2,00	2,50	3,50	5,00	—	1,78	2,79	3,48	4,65	—	4,40	12,70	14,30	0,55	3,43	4,30	2,44	15,23	19,08	3,70	4,00	A	
	2,00	2,50	3,50	7,10	—	1,68	2,63	3,28	5,11	—	4,40	12,70	14,30	0,55	3,43	4,30	2,44	15,23	19,08	3,70	4,00	A	
	2,00	2,50	4,20	4,20	—	1,75	2,74	4,11	4,11	—	4,40	12,70	14,30	0,55	3,43	4,30	2,44	15,23	19,08	3,70	4,00	A	
	2,00	2,50	4,20	5,00	—	1,69	2,64	3,96	4,40	—	4,40	12,70	14,30	0,55	3,43	4,30	2,44	15,23	19,08	3,70	4,00	A	
	2,00	2,50	4,20	7,10	—	1,60	2,50	3,75	4,86	—	4,40	12,70	14,30	0,55	3,42	4,30	2,44	15,19	19,08	3,71	4,00	A	
	2,00	2,50	5,00	5,00	—	1,63	2,55	4,26	4,26	—	4,40	12,70	14,30	0,55	3,42	4,30	2,44	15,19	19,08	3,71	4,00	A	
	2,00	2,50	5,00	7,10	—	1,55	2,42	4,03	4,70	—	4,40	12,70	14,30	0,55	3,42	4,30	2,44	15,19	19,08	3,71	4,00	A	
	2,00	2,50	7,10	7,10	—	1,47	2,30	4,47	4,47	—	4,40	12,70	14,30	0,55	3,42	4,30	2,44	15,19	19,08	3,71	4,00	A	
	2,00	3,50	3,50	3,50	—	1,85	3,62	3,62	3,62	—	4,40	12,70	14,30	0,55	3,42	4,30	2,44	15,19	19,08	3,71	4,00	A	
	2,00	3,50	3,50	4,20	—	1,75	3,42	3,42	4,11	—	4,40	12,70	14,30	0,55	3,42	4,30	2,44	15,19	19,08	3,71	4,05	A+	
	2,00	3,50	3,50	5,00	—	1,69	3,30	3,30	4,40	—	4,40	12,70	14,30	0,55	3,42	4,30	2,44	15,19	19,08	3,71	4,05	A+	
	2,00	3,50	3,50	7,10	—	1,60	3,12	3,12	4,86	—	4,40	12,70	14,30	0,55	3,42	4,30	2,44	15,19	19,08	3,71	4,05	A+	
	2,00	3,50	4,20	4,20	—	1,66	3,25	3,90	3,90	—	4,40	12,70	14,30	0,55	3,42	4,30	2,44	15,19	19,08	3,71	4,05	A+	
	2,00	3,50	4,20	5,00	—	1,60	3,14	3,77	4,19	—	4,40	12,70	14,30	0,55	3,42	4,30	2,44	15,19	19,08	3,71	4,05	A+	
	2,00	3,50	4,20	7,10	—	1,52	2,98	3,57	4,63	—	4,40	12,70	14,30	0,55	3,42	4,30	2,44	15,19	19,08	3,71	4,05	A+	
	2,00	4,20	4,20	4,20	—	1,58	3,71	3,71	3,71	—	4,40	12,70	14,30	0,55	3,42	4,30	2,44	15,19	19,08	3,71	4,05	A+	
	2,00	4,20	4,20	5,00	—	1,53	3,59	3,59	3,99	—	4,40	12,70	14,30	0,55	3,42	4,30	2,44	15,19	19,08	3,71	4,05	A+	
2,00	4,20	4,20	7,10	—	1,45	3,41	3,41	4,42	—	4,40	12,70	14,30	0,55	3,42	4,30	2,44	15,19	19,08	3,71	4,05	A+		
2,00	5,00	5,00	5,00	—	1,44	3,75	3,75	3,75	—	4,40	12,70	14,30	0,55	3,42	4,30	2,44	15,19	19,08	3,71	4,05	A+		
2,50	2,50	2,50	2,50	—	3,18	3,18	3,18	3,18	—	4,40	12,70	14,30	0,55	3,42	4,30	2,44	15,19	19,08	3,71	4,05	A+		
2,50	2,50	2,50	3,50	—	2,99	2,99	2,99	3,74	—	4,40	12,70	14,30	0,55	3,42	4,30	2,44	15,19	19,08	3,71	4,05	A+		
2,50	2,50	2,50	4,20	—	2,82	2,82	2,82	4,23	—	4,40	12,70	14,30	0,55	3,42	4,30	2,44	15,19	19,08	3,71	4,05	A+		
2,50	2,50	2,50	5,00	—	2,72	2,72	2,72	4,54	—	4,40	12,70	14,30	0,55	3,42	4,30	2,44	15,19	19,08	3,71	4,05	A+		
2,50	2,50	2,50	7,10	—	2,57	2,57	2,57	4,99	—	4,40	12,70	14,30	0,55	3,42	4,30	2,44	15,19	19,08	3,71	4,05	A+		
2,50	2,50	3,50	3,50	—	2,82	2,82	3,53	3,53	—	4,40	12,70	14,30	0,55	3,42	4,30	2,44	15,19	19,08	3,71	4,05	A+		
2,50	2,50	3,50	4,20	—	2,67	2,67	3,34	4,01	—	4,40	12,70	14,30	0,55	3,42	4,30	2,44	15,19	19,08	3,71	4,05	A+		
2,50	2,50	3,50	5,00	—	2,58	2,58	3,23	4,31	—	4,40	12,70	14,30	0,55	3,42	4,30	2,44	15,19	19,08	3,71	4,05	A+		
2,50	2,50	3,50	7,10	—	2,44	2,44	3,06	4,75	—	4,40	12,70	14,30	0,55	3,42	4,30	2,44	15,19	19,08	3,71	4,05	A+		
2,50	2,50	4,20	4,20	—	2,54	2,54	3,81	3,81	—	4,40	12,70	14,30	0,55	3,42	4,30	2,44	15,19	19,08	3,71	4,05	A+		
2,50	2,50	4,20	5,00	—	2,46	2,46	3,69	4,10	—	4,40	12,70	14,30	0,55	3,42	4,30	2,44	15,19	19,08	3,71	4,05	A+		
2,50	2,50	4,20	7,10	—	2,33	2,33	3,50	4,54	—	4,40	12,70	14,30	0,55	3,42	4,30	2,44	15,19	19,08	3,71	4,05	A+		
2,50	2,50	5,00	5,00	—	2,38	2,38	3,97	3,97	—	4,40	12,70	14,30	0,55	3,42	4,30	2,44	15,19	19,08	3,71	4,05	A+		
2,50	2,50	5,00	7,10	—	2,26	2,26	3,77	4,40	—	4,40													

# COMBINATIONS TABLE

5U125S2SN1FA Inverter (The values in the table refer to the FLEXIS series)

HEATING																						
UI	Combinations					Output power (kW)					System output power (kW)			Absorbed power (kW)			Absorbed current (A)			COP	SCOP	Energy class
	A	B	C	D	E	A	B	C	D	E	min	nom	max	min	nom	max	min	nom	max			
5	2,00	2,00	2,00	2,00	2,00	2,30	2,30	2,30	2,30	2,30	4,20	11,50	14,30	0,55	3,08	4,30	2,44	13,66	19,08	3,73	4,05	A+
	2,00	2,00	2,00	2,00	2,50	2,28	2,28	2,28	2,28	3,57	4,20	12,70	14,30	0,55	3,40	4,30	2,44	15,10	19,08	3,73	4,05	A+
	2,00	2,00	2,00	2,00	3,50	2,13	2,13	2,13	2,13	4,17	4,20	12,70	14,30	0,55	3,40	4,30	2,44	15,10	19,08	3,73	4,05	A+
	2,00	2,00	2,00	2,00	4,20	2,00	2,00	2,00	2,00	4,70	4,20	12,70	14,30	0,55	3,40	4,30	2,44	15,10	19,08	3,73	4,05	A+
	2,00	2,00	2,00	2,00	5,00	1,92	1,92	1,92	1,92	5,01	4,20	12,70	14,30	0,55	3,40	4,30	2,44	15,10	19,08	3,73	4,05	A+
	2,00	2,00	2,00	2,00	7,10	1,80	1,80	1,80	1,80	5,49	4,20	12,70	14,30	0,55	3,40	4,30	2,44	15,10	19,08	3,73	4,05	A+
	2,00	2,00	2,00	2,50	2,50	2,07	2,07	2,07	3,24	3,24	4,20	12,70	14,30	0,55	3,40	4,30	2,44	15,10	19,08	3,73	4,05	A+
	2,00	2,00	2,00	2,50	3,50	1,95	1,95	1,95	3,05	3,81	4,20	12,70	14,30	0,55	3,40	4,30	2,44	15,10	19,08	3,73	4,05	A+
	2,00	2,00	2,00	2,50	4,20	1,84	1,84	1,84	2,88	4,31	4,20	12,70	14,30	0,55	3,40	4,30	2,44	15,10	19,08	3,73	4,05	A+
	2,00	2,00	2,00	2,50	5,00	1,77	1,77	1,77	2,77	4,62	4,20	12,70	14,30	0,55	3,40	4,30	2,44	15,10	19,08	3,73	4,05	A+
	2,00	2,00	2,00	2,50	7,10	1,67	1,67	1,67	2,61	5,08	4,20	12,70	14,30	0,55	3,40	4,30	2,44	15,10	19,08	3,73	4,05	A+
	2,00	2,00	2,00	3,50	3,50	1,84	1,84	1,84	3,59	3,59	4,40	12,70	14,30	0,55	3,40	4,30	2,44	15,10	19,08	3,73	4,05	A+
	2,00	2,00	2,00	3,50	4,20	1,74	1,74	1,74	3,40	4,08	4,40	12,70	14,30	0,55	3,40	4,30	2,44	15,10	19,08	3,73	4,05	A+
	2,00	2,00	2,00	3,50	5,00	1,68	1,68	1,68	3,28	4,38	4,40	12,70	14,30	0,55	3,40	4,30	2,44	15,10	19,08	3,73	4,05	A+
	2,00	2,00	2,00	3,50	7,10	1,59	1,59	1,59	3,11	4,83	4,40	12,70	14,30	0,55	3,40	4,30	2,44	15,10	19,08	3,73	4,05	A+
	2,00	2,00	2,00	4,20	4,20	1,65	1,65	1,65	3,87	3,87	4,40	12,70	14,30	0,55	3,40	4,30	2,44	15,10	19,08	3,73	4,05	A+
	2,00	2,00	2,00	4,20	5,00	1,60	1,60	1,60	3,75	4,16	4,40	12,70	14,30	0,55	3,40	4,30	2,44	15,10	19,08	3,73	4,05	A+
	2,00	2,00	2,00	4,20	7,10	1,51	1,51	1,51	3,55	4,61	4,40	12,70	14,30	0,55	3,40	4,30	2,44	15,10	19,08	3,73	4,05	A+
	2,00	2,00	2,50	2,50	2,50	1,90	1,90	2,97	2,97	2,97	4,40	12,70	14,30	0,55	3,40	4,30	2,44	15,10	19,08	3,73	4,05	A+
	2,00	2,00	2,50	2,50	3,50	1,79	1,79	2,80	2,80	3,51	4,40	12,70	14,30	0,55	3,40	4,30	2,44	15,10	19,08	3,73	4,05	A+
	2,00	2,00	2,50	2,50	4,20	1,70	1,70	2,66	2,66	3,99	4,40	12,70	14,30	0,55	3,40	4,30	2,44	15,10	19,08	3,73	4,05	A+
	2,00	2,00	2,50	2,50	5,00	1,64	1,64	2,57	2,57	4,28	4,40	12,70	14,30	0,55	3,40	4,30	2,44	15,10	19,08	3,73	4,05	A+
	2,00	2,00	2,50	2,50	7,10	1,55	1,55	2,43	2,43	4,73	4,40	12,70	14,30	0,55	3,40	4,30	2,44	15,10	19,08	3,73	4,05	A+
	2,00	2,00	2,50	3,50	3,50	1,70	1,70	2,66	3,32	3,32	4,40	12,70	14,30	0,55	3,40	4,30	2,44	15,10	19,08	3,73	4,05	A+
	2,00	2,00	2,50	3,50	4,20	1,61	1,61	2,53	3,16	3,79	4,40	12,70	14,30	0,55	3,40	4,30	2,44	15,10	19,08	3,73	4,05	A+
	2,00	2,00	2,50	3,50	5,00	1,56	1,56	2,44	3,06	4,07	4,40	12,70	14,30	0,55	3,40	4,30	2,44	15,10	19,08	3,73	4,05	A+
	2,00	2,00	2,50	3,50	7,10	1,48	1,48	2,32	2,90	4,51	4,40	12,70	14,30	0,55	3,40	4,30	2,44	15,10	19,08	3,73	4,05	A+
	2,00	2,00	2,50	4,20	4,20	1,54	1,54	2,41	3,61	3,61	4,40	12,70	14,30	0,55	3,40	4,30	2,44	15,10	19,08	3,73	4,05	A+
	2,00	2,00	2,50	4,20	5,00	1,49	1,49	2,33	3,50	3,89	4,40	12,70	14,30	0,55	3,40	4,30	2,44	15,10	19,08	3,73	4,05	A+
	2,00	2,00	2,50	4,20	7,10	1,42	1,42	2,22	3,33	4,32	4,40	12,70	14,30	0,55	3,40	4,30	2,44	15,10	19,08	3,73	4,05	A+
	2,00	2,00	3,50	3,50	3,50	1,61	1,61	3,16	3,16	3,16	4,40	12,70	14,30	0,55	3,40	4,30	2,44	15,10	19,08	3,73	4,05	A+
	2,00	2,00	3,50	3,50	4,20	1,54	1,54	3,01	3,01	3,61	4,40	12,70	14,30	0,55	3,40	4,30	2,44	15,10	19,08	3,73	4,05	A+
	2,00	2,00	3,50	3,50	5,00	1,49	1,49	2,92	2,92	3,89	4,40	12,70	14,30	0,55	3,40	4,30	2,44	15,10	19,08	3,73	4,05	A+
	2,00	2,00	3,50	3,50	7,10	1,42	1,42	2,77	2,77	4,32	4,40	12,70	14,30	0,55	3,40	4,30	2,44	15,10	19,08	3,73	4,05	A+
	2,00	2,50	2,50	2,50	2,50	1,75	2,74	2,74	2,74	2,74	4,40	12,70	14,30	0,55	3,40	4,30	2,44	15,10	19,08	3,73	4,05	A+
	2,00	2,50	2,50	2,50	3,50	1,66	2,60	2,60	2,60	3,25	4,40	12,70	14,30	0,55	3,40	4,30	2,44	15,10	19,08	3,73	4,05	A+
	2,00	2,50	2,50	2,50	4,20	1,58	2,47	2,47	2,47	3,71	4,40	12,70	14,30	0,55	3,40	4,30	2,44	15,10	19,08	3,73	4,05	A+
	2,00	2,50	2,50	2,50	5,00	1,53	2,39	2,39	2,39	3,99	4,40	12,70	14,30	0,55	3,40	4,30	2,44	15,10	19,08	3,73	4,05	A+
	2,00	2,50	2,50	2,50	7,10	1,45	2,27	2,27	2,27	4,42	4,40	12,70	14,30	0,55	3,40	4,30	2,44	15,10	19,08	3,73	4,05	A+
	2,00	2,50	2,50	3,50	3,50	1,58	2,47	2,47	3,09	3,09	4,40	12,70	14,30	0,55	3,40	4,30	2,44	15,10	19,08	3,73	4,05	A+
	2,00	2,50	2,50	3,50	4,20	1,51	2,36	2,36	2,95	3,54	4,40	12,70	14,30	0,55	3,40	4,30	2,44	15,10	19,08	3,73	4,05	A+
	2,00	2,50	2,50	3,50	5,00	1,46	2,29	2,29	2,86	3,81	4,40	12,70	14,30	0,55	3,40	4,30	2,44	15,10	19,08	3,73	4,05	A+
	2,00	2,50	2,50	3,50	7,10	1,39	2,18	2,18	2,72	4,23	4,40	12,70	14,30	0,55	3,40	4,30	2,44	15,10	19,08	3,73	4,05	A+
	2,00	2,50	3,50	3,50	3,50	1,51	2,36	2,95	2,95	2,95	4,40	12,70	14,30	0,55	3,40	4,30	2,44	15,10	19,08	3,73	4,05	A+
	2,00	2,50	3,50	3,50	4,20	1,44	2,25	2,82	2,82	3,38	4,40	12,70	14,30	0,55	3,40	4,30	2,44	15,10	19,08	3,73	4,05	A+
	2,00	2,50	3,50	3,50	5,00	1,40	2,19	2,73	2,73	3,65	4,40	12,70	14,30	0,55	3,40	4,30	2,44	15,10	19,08	3,73	4,05	A+
	2,00	2,50	3,50	3,50	7,10	1,33	2,09	2,61	2,61	4,06	4,40	12,70	14,30	0,55	3,40	4,30	2,44	15,10	19,08	3,73	4,05	A+
	2,50	2,50	2,50	2,50	2,50	2,54	2,54	2,54	2,54	2,54	4,40	12,70	14,30	0,55	3,40	4,30	2,44	15,10	19,08	3,73	4,05	A+
2,50	2,50	2,50	2,50	3,50	2,42	2,42	2,42	2,42	3,02	4,40	12,70	14,30	0,55	3,40	4,30	2,44	15,10	19,08	3,73	4,05	A+	
2,50	2,50	2,50	2,50	4,20	2,31	2,31	2,31	2,31	3,46	4,40	12,70	14,30	0,55	3,40	4,30	2,44	15,10	19,08	3,73	4,05	A+	
2,50	2,50	2,50	2,50	5,00	2,24	2,24	2,24	2,24	3,74	4,40	12,70	14,30	0,55	3,40	4,30	2,44	15,10	19,08	3,73	4,05	A+	
2,50	2,50	2,50	2,50	7,10	2,14	2,14	2,14	2,14	4,15	4,40	12,70	14,30	0,55	3,40	4,30	2,44	15,10	19,08	3,73	4,05	A+	
2,50	2,50	2,50	3,50	3,50	2,31	2,31	2,31	2,89	2,89	4,40	12,70	14,30	0,55	3,40	4,30	2,44	15,10	19,08	3,73	4,05	A+	
2,50	2,50	2,50	3,50	4,20	2,21	2,21	2,21	2,76	3,31	4,40	12,70	14,30	0,55	3,40	4,30	2,44	15,10	19,08	3,73	4,05	A+	
2,50	2,50	2,50	3,50	5,00	2,15	2,15	2,15	2,68	3,58	4,40	12,70	14,30	0,55	3,40	4,30	2,44	15,10	19,08	3,73	4,05	A+	
2,50	2,50	2,50	3,50	7,10	2,05	2,05	2,05	2,56	3,99	4,40	12,70	14,30	0,55	3,40	4,30	2,44	15,10	19,08	3,73	4,05	A+	
2,50	2,50	2,50	4,20	4,20	2,12	2,12	2,12	3,18	3,18	4,40	12,70	14,30	0,55	3,40	4,30	2,44	15,10	19,08	3,73	4,05	A+	
2,50	2,50	2,50	4,20	5,00	2,06	2,06	2,06	3,09	3,43	4,40	12,70	14,30	0,55	3,40	4,30	2,44	15,10	19,08	3,73	4,05	A+	
2,50	2,50	2,50	5,00	5,00	2,01	2,01	2,01	3,34	3,34	4,40	1											