

MPX



User manual

→ **LEGGI E CONSERVA
QUESTE ISTRUZIONI** ←
**READ AND SAVE
THESE INSTRUCTIONS**

CAREL
Technology & Evolution

**→ LEGGI E CONSERVA
QUESTE ISTRUZIONI ←**
**READ AND SAVE
THESE INSTRUCTIONS**

We wish to save you time and money!

**We can assure you that a thorough reading of this manual will
guarantee correct installation and safe use of the product described.**

CONTENTS

General Features	2
1. Main features of the multiplexed Master/Slave units	3
2. Models in the MPX series	5
3. Installation	6
3.1 Electrical connections	6
4. User interface - Buttons and display	7
4.1 The LED display	7
4.2 Operating indications	7
4.3 Keypad	7
5. Configuration of the controllers	9
5.1 Configuration of the controllers as Master or Slave:	9
5.2 Selecting the principal operating parameters	9
5.3 Other important parameters	10
5.4 Important parameters for all units (Master/Slave).....	10
5.5 List of parameters to be checked during installation.....	11
6. Programming	12
6.1 Accessing the parameters	12
6.2 Modifying the parameters	12
6.3 Exiting the programming procedure	13
6.4 Manual reboot of the controllers.....	13
7. Programming by remote control	14
7.1 Remote control layout.....	14
7.2 Introduction	14
7.3 Technical specifications.....	15
7.4 Description of the keypad	15
7.5 The PSW button and the command buttons.....	16
7.6 How to use the remote control	16
8. Re-configuring a control with the default parameters	18
9. The alarm log	19
10. New local network functions	20
10.1 Network defrost for multiplexed systems.....	20
10.2 Remote alarm signals	20
10.3 The network auxiliary relay	20
10.4 Configuring a network by “downloading” the parameters from the Master unit	20
10.5 Functions available to the RS485 serial supervisory system.....	21
11. DESCRIPTION OF THE CONFIGURATION PARAMETERS	22
11.1 Configuration parameters.....	22
11.2 Parameter categories	22
11.3 The password	22
11.4 / = parameters for the management of the temperature probes.....	23
11.5 r = parameters for temperature regulation.....	25
11.6 c = parameters for compressor management	27
11.7 d = Parameters for defrost management.....	30
11.8 A = parameters for alarm control	33
11.9 Digital inputs and description of the interface commands for the supervisor	34
11.10 F = parameters for controlling the evaporator fans.....	38
11.11 H = other settings	39
12. Operating states of the units	41
12.1 Sequence of the main phases	41
13. Alarms	42
13.1 Defective or incorrect operation	42
13.2 Description of the signals flashing on the display of the MPX.....	42
14. Troubleshooting	44
15. Technical specifications	45
15.1 Technical characteristics:	45
15.2 Temperature/Resistance ratios for NTC thermistors	46
15.3 View of the instrument	47
16. WIRING DIAGRAMS	48
16.1 MPX contact rear view:	48
17. Summary of parameters	49

General Features

The multiplexed Master/Slave units belong to the MPX Series for refrigeration, made up of microprocessor-controlled electronic controllers with LED display, specifically designed for the management of refrigeration units. In this particular case the refrigeration units may be stand-alone type or grouped together as multiplexed cabinets.

1. Main features of the multiplexed Master/Slave units

Power supply

12V alternating current

Soft touch keypad

The aesthetics of the MPX Series have been designed to blend harmoniously with the new lines of the refrigeration units. In the MPX Series, special attention has been paid to the "ergonomic" aspect. In this way, the modification of parameters and the setting of the more common functions can be done by simply pressing **only** one button at a time, simplifying the use of the instruments.

New rear connections

The rear connectors have been redesigned to make the instrument effectively a plug & play unit.

LED Display

The LED display shows two and half digits with a range from $-55\div+95^{\circ}\text{C}$; the temperature value appears with one decimal point (which can be omitted via the setting of the relative parameter) in the range from -19.9 to $+19.9^{\circ}\text{C}$. In addition, depending on the model, up to 4 LEDs are available for signalling the active "actuators".

Buzzer

All controls come complete with an alarm buzzer upon request.

LAN

The multiplexed Master/Slave units can operate both in Stand Alone mode and connected together in a network for the management of multiplexed refrigeration cabinets. The unit configured as the Master in this case synchronises the defrost of all the slave cabinets. The individual units, on start-up, can be configured either as Master or as Slave. The LAN is set-up using a half-duplex two-lead serial interface, which allows up to 6 units to be connected together (1 Master + 5 Slave).

Alarm log

Each individual unit features a log with a maximum of 9 alarms: each new alarm is recorded in the log where it can be consulted by the user.

RTC

Some models are fitted with RTC (battery backup) and allow the management of the defrosts at pre-set times. Up to 8 defrost times can be set during a day (24 hours). In the models where RTC is not featured, the defrosts can in any case be performed cyclically or manually .

Third probe

Used for measuring the temperature in the hot point of the refrigerated cabinet, this can be displayed as a frequent parameter, and corresponds to new parameter "dA". Probe 3, on a stand alone instrument, may also be used to manage the defrost on a second evaporator.

Duty setting

A completely new function allows the compressor to run even if the regulation probe is damaged. In the case of a short-circuit or open-circuit probe, the compressor is instructed to start on the basis of time-intervals (minutes) selected using the 'duty setting' parameter ('c4') and to turn OFF every 15 minutes (fixed time-interval).

Multifunction input

The multiplexed units are fitted with three digital inputs, which can be configured by setting parameters A4, A5 and A8 respectively. Two of these are physical, that is, relate to an electrical contact (parameters A4, A5), while one is related to the LAN (parameter A8), for the Slave models, or to the RS-485 serial interface for the Master models fitted with RS-485 serial interface. These inputs can be used to enable/disable defrost, to manage serious alarms that require the immediate (e.g. high pressure) or delayed (e.g. low pressure) shut-down of the unit, or for remote control by the Master models and/or a supervisory system.

Multifunction output

A fourth relay is present to remote the alarm signal or to control the On/Off command of accessory devices. If the FAN relay is not used to control the fans it can be used as an auxiliary relay; in this case the fourth relay can be used as an alarm relay.

Continuous cycle

This function operates the ON routines of the compressor for a time 't', selected via a specific parameter. This is particularly useful when a rapid drop in temperature is required.

Serial connection

Some Master models are fitted with a built-in RS-485 serial interface, which allows them to be connected to a supervisory system. These units can therefore act as a gateway between the supervisory system and the local multiplexed sub-network they are part of.

Dimensions

Even the most sophisticated model has standard dimensions. The dimensions required on the panel are in fact 71x29 mm.

Index of protection

In the MPX series the 'O-RING' inside the front panel and the material used for the keypad ensure the controller IP65 index of protection. In addition, a flat gasket is supplied as standard in order to increase the index of protection of the panel the instrument is mounted on.

Fastening the unit

The unit is fastened using a compact, quick-fit plastic fastening bracket. This allows the instrument to be mounted on the panel without requiring the use of screws.

Test in circuit

The instruments in the MPX series are the result of the most advanced SMD technology. All controls are built using high quality components. Quality control includes a rigorous 'TEST-IN-CIRCUIT' on each single component to ensure that the controller is completely reliable.

NTC probe

The MPX instruments have been designed to be connected to Carel NTC probes, as these offer greater precision than other probe types.

Watchdog

A special device that protects the microprocessor of the controller even in the event of strong electromagnetic noise. In the case of abnormal conditions, the watchdog restores the initial operating status of the unit.

Immunity against noise

The devices conform to EU standards on electromagnetic compatibility.



& ISO9001 Approvals

The quality and safety of the MPX series are assured by the ISO 9001 design and production certification, as well as the CE Mark.

2. Models in the MPX series.

The models in the MPX series have different codes according to their features. The table below lists the various codes and the corresponding options that characterise each model:

OPTIONS

MODEL CODE	SPC	RS485	4 RELAY	IR	RTC	BUZZER
IRMPX00000						
IRMPX0M000		•				
IRMPX0A000						•
IRMPX10000			•			
IRMPX1M000		•	•			
IRMPX1A000			•			•
IRMPXM0000			•		•	
IRMPXMM000		•	•		•	
IRMPXMA000			•		•	•

3. Installation

Actual installation:

- 1) insert the instrument into the previously-created opening;
- 2) fasten the instrument to the panel by sliding it onto the fastening bracket.
- 3) insert the rear connectors of the instrument into the corresponding pre-wired connectors
- 4) close the panel
- 5) connect the power and configure the operating parameters.

3.1 Electrical connections

Warning: Before performing electrical installation, read the instructions and take careful note of the diagrams on the following pages (cap. 16). Remember that all safety devices necessary for correct operation must be fitted in advance.

To install the controllers, the following cables must be pre-wired to special connectors:

12-way connector: power, LAN communication channel, analogue probes, digital inputs.

14-way connector: relay outputs.

The IRMPX*M* models feature RS485 serial connection (using a special connector with removable terminals).

The RS485 connection is made to installations featuring a supervisory system. Once the connections have been pre-wired, the controllers can be easily replaced without having to repeat the pre-installation operation described above.

Installation should be avoided in the following circumstances:

1. Relative humidity greater than 85%,
2. Heavy vibration or shocks,
3. Exposure to continuous water sprays,
4. Exposure to corrosive or pollutant gases (e.g. sulphur or ammonia fumes, saline mist, smoke) so as to avoid corrosion and oxidation,
5. Strong magnetic and/or radio interference (therefore installation of the unit near transmitter aerials should be avoided),
6. Exposure of controls to direct solar radiation and other climatic elements.

The following warnings must be heeded when making the connections during the pre-installation of the controllers:

1. Connecting a power supply of the incorrect voltage can seriously damage the system.
2. So as to avoid any possible electro-magnetic interference, separate as far as possible the signal leads from the probes and the digital inputs, from the induction and power leads. Do not place power leads and probe leads in the same channels. Furthermore, avoid placing probe leads in the immediate vicinity of powered components (thermo-magnetic contacts or others). Keep the probe leads as short as possible and avoid sharing their routes with power leads. As defrost probes use only guaranteed IP67 sensors; place the probes with the bulb in an upright position to assist the drainage of any condensation that may occur. Note that thermistor temperature probes (NTC or PTC) have no polarity, and so the terminals may therefore be connected either way.
3. If connection to a supervisory network is featured, connect the shield of the RS485 channel to the 485 ground on the instrument.
4. The secondary side of transformers supplying the units must not be earthed. If it is necessary to connect to a transformer that has a secondary earth, an insulating transformer must be installed in between.
5. If more than one control is connected to the same transformer, refer to the following wiring diagrams for details of the wiring method.

4. User interface - Buttons and display

Each instrument features:

- 12Vac power supply;
- two and a half digit display;
- temperature display to the tenths;
- LED indicating the output state;
- 4 buttons for programming;
- buzzer (according to model)

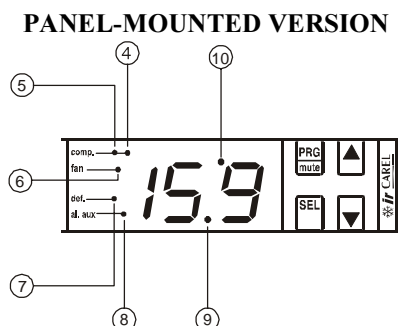

4.1 The LED display

The display shows temperature in the range -55 to 95°C.

The temperature measured by the probe is displayed with decimal resolution, between -19.9 and +19.9.

It is possible to exclude the decimal point by modifying the value of parameter /6.

According to the function in progress, the display shows one of the following:

- in normal operation: temperature measured by the probe selected by parameter /7;
- in parameter selection phase: code of the parameter or the value associated to it;
- in the presence of an alarm condition: flashing code of the alarm detected alternated to detected temperature value.

4.2 Operating indications

On the display are some signal areas (see ③, ④, ⑤, ⑥, ⑦ and ⑧ in the figure). They indicate:

- 4** compressor operating;
- 4b** continuous cycle active;
- 5** fan operating;
- 6** fourth relay energised;
- 7** defrost in progress
- 8** decimal point;

4.3 Keypad

The buttons present on the front allow the following functions:



- ① - goes to the next parameter;
- increases the value associated with the parameter;
- activates/de-activates the auxiliary output
- resets the remote alarm signal (on Master unit)
- resets the remote alarm and failed download signal (on the Master)

if pressed together with button 1 :

- activates the continuous cycle
- on start-up, displays the identification code of the software version loaded on the controller, preceded by a graphic symbol

if pressed for 5 seconds together with buttons 2 and 9:

- in normal operation resets the controller



②

- stops the audible alarm for 10 minutes(only if fitted);
- if pressed for over 5 seconds:**
- accesses the menu of the type "F" parameters (frequent);
- if pressed for more than 5 seconds together with button 9:**
- accesses the menu of the type 'C' parameters (configuration);
- accesses the alarm log via password (= 44)
- activates the parameter download from the Master units, via password (=66)
- if pressed at instrument start-up:**
- activates the procedure for reloading the controller's default configuration
- if pressed for 5 seconds together with buttons 1 and 9:**
- in normal operation resets the controller



⑨

- displays and/or selects the SET-POINT;
- displays the value associated to the selected parameter;
- if pressed for more than 5 seconds together with button 2:**
- accesses the type "C" parameter menu (configuration);
- allows access to the unit-configuration "In" parameter as Master or Slave at the Boot of the unit or immediately after its reset;
- if pressed together with button 10:**
- on Master units starts a network defrost on the entire multiplexed island;
- on all units, if pressed during the start-up of the controller, resets the alarm log.
- if pressed for 5 seconds together with buttons 1 and 2:**
- in normal operation resets the controller
- if pressed alone for 5 seconds during the probe test phase:**
- accesses the manual probe calibration procedure (see calibration)



⑩





- resets the temperature alarms and restarts their monitoring;
- attempts to reload the parameters, if there is a configuration read error during the start-up of instrument;
- passes from one parameter to the previous;
- decreases the value associated to the parameter;
- if pressed for more than 5 seconds:**
- activates a manual defrost;
- if pressed together with button 1 (*):**
- activates/deactivates the continuous cycle;
- on start-up displays the identification code of the software version loaded on the controller, preceded by a graphic symbol
- if pressed together with button 9:**
- on Master units starts a network defrost on the entire multiplexed island;
- on all units, if pressed during the start-up of the controller, resets the alarm log.

(* **Note:** to enable/disable the continuous cycle. press button 10 and button 1 and hold for 5 seconds.

5. Configuration of the controllers.

The multiplexed units are supplied ready for use. They have in fact been programmed using a default configuration so as to satisfy the more common requirements. Programming is performed by assigning all the parameters the more-frequently required value. These values are listed in the table of parameters at the end of the manual. If the user wants to maximise the operation of the controllers or has other specific regulation needs, the value of the operating parameters can be modified. The following notes indicate the default values and the parameters that are more frequently modified before starting to operate the unit.

5.1 Configuration of the controllers as Master or Slave:





- on start-up of the unit press the  and  buttons together for 5 seconds;
- the display shows the configuration parameter code “In”;
- press the  button to modify the value: **0** = Slave unit; **1** = Master unit;
- press  again to temporarily confirm the new value and move onto the display of the parameter code;
- press the  button to save the new value and exit the Master or Slave configuration procedure; the unit will perform a software reboot;

NOTE: the controllers are Master or Slave as default depending on the model and its options:
all the models featuring RTC with battery backup and/or built-in RS485 interface are set as Master units.

5.2 Selecting the principal operating parameters









How to set the ambient set-point

The instrument is configured with a default set point of -10°C. If this is not compatible with the required application it can be modified as follows:

- press the  button for one second to display the value of the set-point; the previously set value will flash;
- increase or decrease the value of the set-point using the  and/or  buttons until the desired value is displayed;
- press the  button again to confirm the new value.

How to set the differential (regulator hysteresis)

The instrument is programmed with a differential of 2 degrees as default. If this is not compatible with the required application it can be modified as follows:

- press the  button for more than 5 seconds (in case of alarm, first silence the buzzer, if fitted);
- the display shows the code of the first modifiable parameter (/C);
 - press the  button or  button until the code “rd” is displayed;
 - press  to display the associated value;
 - increase or decrease the value using the  and/or  button until the desired value is displayed;
 - press  again to temporarily confirm the new value and move onto the display of the parameter code;
 - press the  button to save the new value and exit the parameter modification procedure.

5.3 Other important parameters

LAN configuration parameters:

For the Master:

- parameter “Sn” (Slave number): from 1 to 5; number of Slaves in the LAN; during boot the display shows “uM” : unit-Master
- parameters for setting defrost times: “hx”, “mx”; x = 1, 2,... , 8: hours and minutes of defrost times; the tens of minutes can be set (only if RTC is present)
- parameters “hh” and “mm” : current hour and minute (only if RTC is present)

For the Slaves:

- parameter “SA” (Slave address): address of the slave in the LAN; during machine boot, if configured as Slave, “uN” is displayed, where N = SA (e.g.: u1, if the address of the Slave in the LAN is 1; SA = 1)

5.4 Important parameters for all units (Master/Slave)

As indicated, the instruments are factory-programmed to measure both the high and the low temperature alarm. The alarms set off the internal buzzer, if fitted, and show a code on the display: HI for the high temperature, and LO for the low temperature.

The conditions that generate a temperature alarm are:

- **high temperature alarm:** the temperature measured by the ambient probe is above the set-point by a value greater than AH (ambient temperature > set point +AH),
- **low temperature alarm:** the temperature measured by the ambient probe is below the set-point by a value greater than AL (ambient temperature < set point -AL).

The default settings are AL= 4 and AH = 4, and any signalling of the alarm is delayed by 120 minutes (Ad=120). The value associated to “Ad” in fact indicates the number of minutes of delay that the controller must wait before generating a temperature alarm. Obviously, if during the set delay the temperature conditions return within the set limits (that is, within the ± 4 degrees around the set-point) no alarm is generated.

NOTE: during installation the unit may not reach a temperature within the range of ± 4 degrees around the set-point within the set 120 minute delay, and so the temperature alarm will be activated. In this case, it is suggested to increase the delay by modifying parameter Ad.

DEFROST PARAMETERS

When using the unit to control defrost, check the following parameters before starting the unit:

dI: Interval between defrost cycles (without RTC or without programmed times)

Defrost cycles occur periodically, depending on the intervals (in hours) set using the parameter 'dI'. When the interval is 0 (dI=0), the defrost cycle is never performed, unless it is forced via keypad (manual defrost), via the digital input (see parameter A4) or by a command from the Master in a LAN. Temperature alarms are inhibited during defrosts.

If the parameter is set to a value other than the default value, the new value will be operative only after the successive defrost.

Def.: 8 (hours)

NOTE: even when cyclical defrosts are not expected to be used (for example, with RTC or otherwise), “dI” should not be set to 0, but rather to a value that is higher than the maximum interval between two defrosts. This acts a safety function, as it ensures at least one defrost is performed every “dI” hours even when, due to unforeseen anomalies, the programmed defrosts would normally not be performed. This will not affect the normal performance of the programmed defrosts, as the timer associated to the value of “dI” will be restarted at the end of each defrost.

dP: Maximum defrost time

The parameter dP determines the maximum duration of the defrost cycle, in minutes. This parameter represents the effective duration of the defrost when d0 = 2 or d0 = 3. If this parameter is modified while a defrost is in progress, the new setting will not influence the duration of the current defrost, but rather that of the successive defrost.

Def.: 30 minutes

d0: Type of defrost

Establishes the type of defrost:

0 = defrost by electrical heating element, 1 = defrost by hot gas, 2 = timed defrost by electrical heating element,
3 = timed defrost by hot gas;

Def.: d0=0, electrical heater defrost by temperature

dt: End defrost temperature

This parameter allows the end defrost temperature, as measured on the evaporator, to be set. In any case, the maximum defrost time is equal to the value, in minutes, set for parameter dP. When the temperature measured by the defrost end probe is higher than the defrost end temperature set by the user, the defrost cycle will not be performed, that is, only the following dripping and, if required, post-dripping phases will take place. The use of the third probe as a defrost probe on a second evaporator allows an end defrost when both probes (S2 and S3) measure a temperature above that set for parameter “dt”.

Def.: 4°C

5.5 List of parameters to be checked during installation

Code	Parameter	Type	Min	Max	UOM	Def
<i>LAN PARAMETERS</i>						
Sn	Number of slaves (for the Master)		0	5	-	0
SA	Address in the LAN (for the Slave)		0	5	-	0
<i>CONTROL PARAMETERS</i>						
rd	Control differential	F	0.1	+19.9	°C/°F	2
<i>DEFROST PARAMETERS</i>						
d0	Type of defrost	C	0	1	flag	0
dI	Interval between defrost cycles	F	0	199	hours	8
dt	Defrost end temperature	F	-40	+199	°C/°F	4
<i>ALARM PARAMETERS</i>						
Ad	Temperature alarm delay	C	0	+199	min	120
<i>FAN PARAMETERS</i>						
F4	Fan relay used for the fans or as auxiliary	C	0	2	-	0
<i>OTHER FUNCTIONS</i>						
H0	RS485 serial address (only for Master with RS485)	C	0	199	-	1
H1	Configuration of fourth relay (auxiliary and/or alarm)	C	0	3	-	0
<i>DEFROST TIMES (only for Master with RTC)</i>						
h1	Hour of the first defrost time able to be set	C	0	24	hours	24
m1	Minute of the first defrost time able to be set	C	0	50	min	0
...						
h8	Hour of the eighth defrost time able to be set	C	0	24	hours	24
m8	Minute of the eighth defrost time able to be set	C	0	50	min	0

6. Programming

The microprocessor in the MPX instruments allows the configuration of the functions of the controller according to the application requirements. To simplify this operation, we have divided the operating parameters into two main groups:

- frequently used parameters (indicated as 'F' parameters in the tables below);
- configuration parameters ('C'), protected by a code or password to prevent unauthorised access to the data.

The parameters are modifiable as follows:

- using the keypad on the front panel
- via LAN (download the parameters from the Master to its connected Slaves)
- if the relative options are available, from the RS485 serial network (using the Master as a protocol converter, the parameters can be read from Supervisory system and written to Slave units which are not physically connected to the RS485 serial communication channel).



To modify the parameters using the keypad on the front panel, proceed as described in the following paragraphs.



6.1 Accessing the parameters

To access the 'F' parameters:

press the  for more than 5 seconds (in the case of an alarm condition, silence the buzzer first);
the display shows the code of the first modifiable parameter (/C);

To access the 'C' parameters:

press the  and  buttons simultaneously for more than 5 seconds;
the display shows 00;



press either the  or  button until '22' (access password for the type "C" parameters) appears;

confirm by pressing ;
the display shows the code of the first modifiable parameter, that is '/C'.

6.2 Modifying the parameters

Modifying parameters

After having displayed the first parameter, either 'C' or 'F', follow these instructions.

press either  or  until reaching the parameter whose value needs to be changed;

press  to display its current value;

increase or decrease its value using the  or  key until reaching the required value;

press  to temporarily save the new value and display the code of the parameter again;

- To modify the values of the other parameters, repeat all the operations from the "modifying the parameters" paragraph.



Saving the new values:

- Push the PRG button to save the new value/s and exit from the parameter modification procedure.

How to exit the procedure

How to save the new set values



- Press  to save the new values and exit the procedure.

Important: press  to save the new values. In the case of power failure before  has been pressed, all changes will be lost.

6.3 Exiting the programming procedure

To exit the programming procedure without saving the changes, do not press any key for at least 60 seconds (TIME OUT). The instrument will return to its normal operating mode.

6.4 Manual reboot of the controllers

The controllers can be manually rebooted at any time without disconnecting the power. This is done by pressing the ,  and  buttons together and holding them for 5 seconds.

This procedure may be useful if operating anomalies occur during the configuration / installation of the instrument, after having changed some important configuration parameters, such as the configuration of the digital inputs.

7. Programming by remote control

(AVAILABLE FOR THE FOLLOWING MODELS: IRMPX0A000, IRMPX1A000, IRMPXMA000)

7.1 Remote control layout

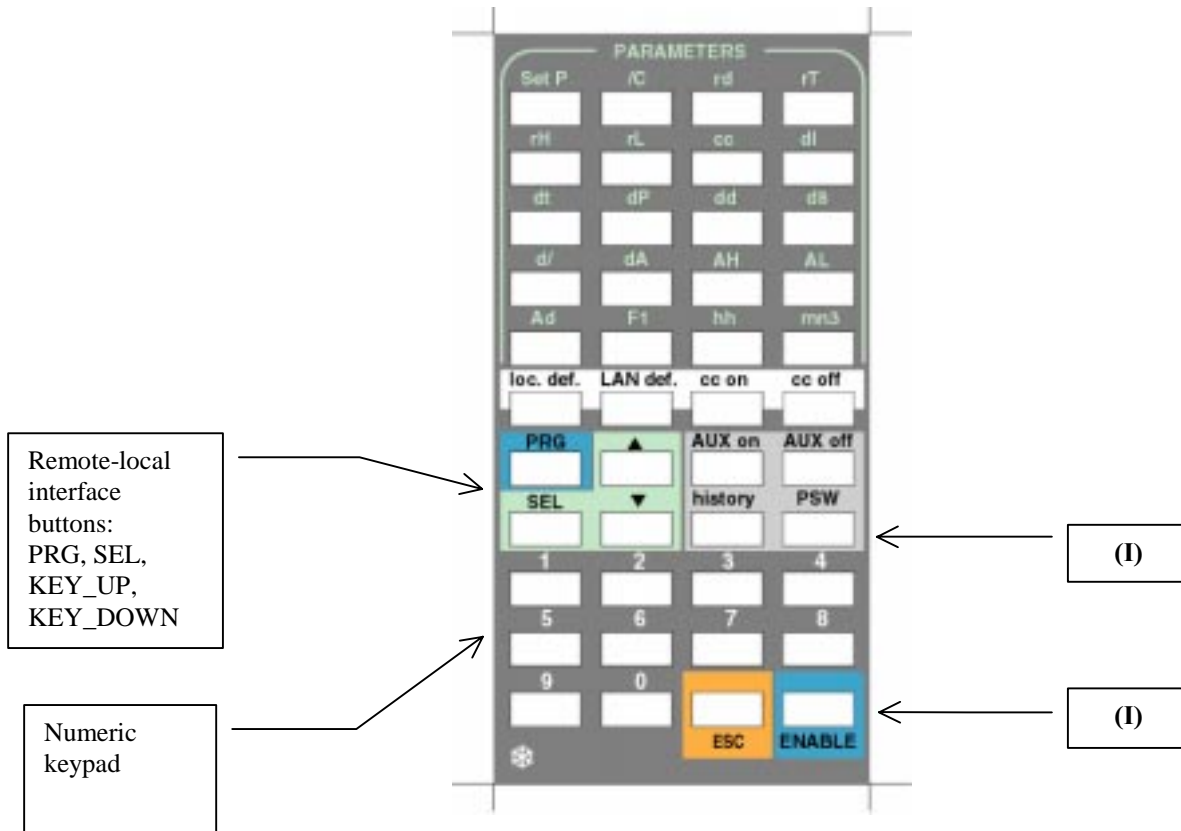

Fig. 1

(I): Function buttons; History, PSW, ESC, ENABLE.

7.2 Introduction.

The remote control for the IRMPX series has been designed to provide the user, in the palm of their hand, **all** the functions offered by the MPX family instruments and its local network structure:

1. Remote programming of the individual instrument (direct access to the parameters and/or by entering password 22 on the remote control);
2. Remote programming of a multiplex network, using the Master unit only, starting the “download” from the remote control;
3. Remote setting of the defrost times (only for models with RTC and configured as Master);
4. Remote setting of the current hour and minute current (only for models with RTC and configured as Master);
5. Direct access, by simply pressing one button, to the alarm logs;
6. Direct remote access to the local auxiliary relay;
7. Direct remote access to the network auxiliary relay, using the remote control on the Master unit;
8. Remote silencing of the buzzer (switching off the corresponding local alarm relay);
9. Remote starting of manual defrosts (local and/or network).

In implementing the user interface for the MPX remote control, the aim has been to provide harmonious expansion, that is, to offer the user all the functions available on the local keypad, as well as some extra options (direct access to the parameters, the defrost times, the alarm log, separate management of the network relay and local relay) that the local user interface does not have. The available functions are accompanied by the following **system security features** aimed at protecting the user:

- No control configuration parameters can be modified by accident from the remote control.
- Each instrument has its own enabling code for the use of the remote control, set by parameter **H3**. When **H3** is assigned a value other than zero during the installation of the instruments, the use of the remote control is disabled as default. Only the **START** procedure (see below) can access the functions of the remote control: in this case, the value saved for **H3** acts as the access code.
- Assigning different **H3** values for each instrument allows the same remote control to be used with different controllers.
- The faulty pressing of buttons on the remote control for one minute disables the remote control, in which case the **START** procedure is required before being able to use it again.

7.3 Technical specifications

Power supply	2 alkaline batteries, 1.5V (type UM-4 AAA, IEC R03)
Case	plastic
Dimensions	60x160x18mm
Storage	-25°C ÷ +70°C
Operating temperature	0°C ÷ 50°C
Type of transmission	Infrared
Weight	80 g (without batteries)

7.4 Description of the keypad

The buttons can be divided into the following groups, based on their functions,:

- function buttons: to activate/deactivate the use of the remote control, to access the alarm log and for the password entry prompt;
- pre-programmed buttons to modify the main parameters;
- pre-programmed buttons to send direct commands (activate aux relay, start defrost, etc....);
- buttons that repeat the local keypad on the instrument.

When a button is pressed on the remote control, the LED above the decimal point on the main display of the instrument is turned on. The LED will stay ON while the button is pressed on the remote control.

7.4.1 Function buttons

ENABLE : accesses the procedure for enabling the use of the remote control.

History : direct access to the alarm logs

PSW : accesses the password entry prompt

ESC:

- 1) exits the parameter programming phase, without saving the modifications made (this option is not available on the local user interface, where the parameter programming phase is exited by timeout);
- 2) ends a session (dialogue with an instrument) on the remote control.

NUMERIC KEYPAD: sets the enabling code for using the remote control. This code is recommended when more than one controller is within the operating range of the remote control, as in the case of a series of controls installed in an electrical panel. Selecting a different code for each instrument allows the remote control to interact with the required controller only. For the use of the buttons, see the section “HOW TO USE THE REMOTE CONTROL”.

Buttons used to modify the main parameters (direct access buttons)

All type F parameters and “cc” and “Ad” parameters, type C, are directly accessible from the remote control, and their identification code is shown next to the associated button. For the use of the buttons, see the section “HOW TO USE THE REMOTE CONTROL”.

7.4.2 Buttons for the remote control of the instrument’s keypad

The PRG, ▲, ▼, SEL buttons reproduce the functions of the controller’s local keypad on the remote control. The main functions are summarised below for convenience:

SEL displays the value of the selected parameter and accesses the set-point



- 1) passes from one parameter to the next;
- 2) increases the data on the display, when setting the value of the parameters;
- 3) scrolls the alarm log;
- 4) accesses the network auxiliary relay.



- 1) passes from one parameter to the previous;
- 2) decreases the data on the display, when setting the value of the parameters;
- 3) starts a local defrost;
- 4) scrolls the alarm log.

PRG:

- 1) pressed for 5 sec accesses the type F parameters;
- 2) permanently saves the values of the modified parameters and exits the parameter programming mode;
- 3) silences the buzzer if activated when the controller is not in parameter programming mode.

7.5 The PSW button and the command buttons.

7.5.1 The PSW button: enter the system password from the remote control

Pressing the PSW button for at least 5 seconds accesses the enter prompt for the system password (see using the local keypad and Table of parameters):

- 22 (C parameters);
- 44 (read log);
- 66 (start download procedure).

To enter a password from the remote control, proceed as follows:

- press PSW for at least 5 seconds;
- the password entry prompt will appear (00 blinking);
- set the password using the arrow buttons, ▲ and ▼, on the remote control;
- press the SEL button to confirm.

7.5.2 Direct access to the alarm log

Pressing the HISTORY button allows direct access to the controller's alarm log. The ▲ and ▼ buttons on the remote control scroll the list of the saved alarms. To exit the display of the alarm log, press the PRG button. Access to the log is inhibited when the instrument is in parameter programming mode. Similarly, access to the parameter programming mode is inhibited while the log is displayed.

7.5.3 Command buttons:

- **Lan_Defr** : starts a network defrost (valid only on units configured as Master).
- **CC_ON** : starts the continuous cycle.
- **CC_OFF** : stops the continuous cycle.
- **AUX_ON** : switches on the local auxiliary relay.
- **AUX_OFF** : switches off the local auxiliary relay.
- ▲ : toggles the network auxiliary relay (on/off).

7.6 How to use the remote control

7.6.1 ACCESS WITHOUT USING THE CODE (H3 = 0)

The ENABLE button is not required if H3 = 0. In this case, the remote control is always enabled.

7.6.2 ACCESS USING THE CODE (H3 ≠ 0)

How to set the access code: setting the code

The controllers are supplied by the manufacturer without the access code. To enter the code, modify parameter H3. Proceed as follows:

- press PSW for at least 5 seconds;
- the controller will show the password entry prompt;
- enter the password 22, using the arrow buttons on the remote control;
- confirm by pressing the SEL button;
- press ▼ until parameter H3 is displayed on the controller;
- press SEL to display the value (00, default);
- use ▲ to set the required code (thus must be a value between 01 and 99);
- press SEL to confirm the new value and return to the display of parameter H3;
- press PRG to exit, saving the code.

Removing the code

Repeat the previous procedure, **assigning the value 00 to H3**. In this way, the remote control can be used without requiring the access code.

7.6.3 ENABLING THE CONTROLLER FOR RECEIVING COMMANDS FROM THE REMOTE CONTROL

- press the **ENABLE** button to enable the use of the remote control;
- the instrument will display a two digit code (the value of parameter H3);
enter the code displayed using the numeric keypad on the remote control. The code must be entered correctly, without ignoring the zeroes (e.g. if the display on the controller shows 05, type 0 then 5 on the remote control);
- If the code entered corresponds to the code shown on the instrument, full access is provided to the functions of the remote control, and the controller enters parameter F programming mode: the code “/C” will be displayed, corresponding to the parameter “ambient probe calibration”.
- If the code entered does not correspond to the code displayed, the controller will immediately exit the START procedure and will ignore the pressing of any buttons on the remote control, other than the **ENABLE** button.

7.6.4 MODIFYING THE MAIN PARAMETERS

The buttons on the remote control used to modify the parameters (buttons labelled with codes), allow direct access to all type F parameters (frequent) for the instrument, as well as type C (configuration) parameters “Ad” and “cc”. To access one of these, proceed as follows:

- press the button associated to the corresponding parameter;
- the code of the parameter will blink on the display;
- pressing the arrow buttons on the remote control scrolls the entire list of F parameters. The possibility of scrolling the list of parameters is inhibited, for safety reasons, for direct access configuration parameters: **cc**, **Ad**, and defrost times;
- press the **SEL** button on the remote control to display the current value of the parameter;
- press the arrow buttons to modify the value;
- press the **SEL** button to temporarily confirm the value entered;
- pressing **PRG** will permanently save the new value;
- pressing the **ESC** button will exit the parameter programming mode without saving the changes.

7.6.5 Setting the clock (only for Master with RTC)

Press the **hh** button to set the hours and the **mm** button to set the minutes. Follow the same procedure as above.

7.6.6 MODIFYING THE DEFROST TIMES (only for Master with RTC):

Proceed as follows:

- press **hh** (for hours) / **mm** (for minutes);
- press a numeric button from 1 to 8 to select the required hours/minutes for the defrost being set;
- the display will show the fixed code **hn / mn** ($n = 1, \dots, 8$);
- press the **SEL** button on the remote control to display the current value of the parameter;
- press the arrow buttons to modify it;
- press the **SEL** button to temporarily confirm the value entered;
- pressing **PRG** will permanently save the new value;
- pressing the **ESC** button will exit the parameter programming mode without saving the changes.

When displaying the code associated to the hours or the minutes of any defrost time, pressing a button on the remote control numeric keypad associated to a defrost time other than the one being displayed will access the associated defrost time.

Example: assume parameter “h8” (“m8”) is displayed, that is, the hours (minutes) associated to the eighth defrost time that can be set. Pressing button 2 on the numeric keypad will show the code “h2” (“m2”), associated to the second defrost time that can be set.

8. Re-configuring a control with the default parameters

Under exceptional conditions – high electromagnetic noise levels, for example – there may be errors when storing data. Consequently, the unit may not work correctly. When the microprocessor identifies an error in the process of storing data, one of the following groups of letters will be displayed:





EA, EB, -E-

The last symbol will only appear at the start-up of the instrument.

To reset correct operation a special **RESET** procedure must be followed.

This procedure is only to be performed in exceptional circumstances, as its possible causes are exceptional. Thanks to the RESET procedure, it is almost always possible to reset correct operation. In any case it is useful to investigate the cause of this type of error to be able to prevent it from occurring again. Special attention is drawn to the “Installation” chapter and the “Warnings” paragraph on page 9 of this manual.

To reset the controller:

- disconnect power from the instrument or reset it manually by pressing the PRG & SEL & UP buttons together for 5 seconds;
- During the start-up / reboot of the instrument, press and hold the  button;
- the display shows "    ";
- hold the  until the display shows the decimal point
- in this way the instrument indicates that it is accessing the default configuration parameters
- once the default configuration is reloaded, the instrument automatically performs a reboot

Important: *after the RESET procedure the values of each single parameter will be the default values. Any modifications made before the reset procedure will therefore be lost*

Important note: *given the delicate nature of this operation, the reset procedure must be carried out by specialised personnel. In any case the procedure **will not damage** the instrument, but rather simply return it to the state in which it was purchased. Thus, if the operating parameters have been incorrectly or randomly modified to the point where the controller no longer functions as desired, it can be reset to its initial configuration.*

If following the above-described procedure the “-E-” symbol remains during power-on, followed by the letters EB, press the  button until the letters disappear. If the EB error remains and the letters EA appear, the instrument must be replaced. If, on the other, hand the letters disappear the controller can continue to be used. If the EB error occurs frequently and/or tends to persist, the controller should be checked as its original specified precision can not be guaranteed.

9. The alarm log

All the models in the MPX Series are fitted with an alarm log that records up to until 9 alarm signals. The models configured as Master and fitted with RTC also allow the display of the age of each alarm, that is, the time in hours elapsed between the moment in which the log is consulted and the time the alarm was recorded.

Events recorded in the log:

The following anomalies are saved in the log:

- the high and low temperature alarms,
- the regulation probe error (probe S1 and/or probe S3 short-circuited and/or open)
- the defrost probe error, short-circuited and/or open
- the signalling of temperature defrost ended due to timeout (if enabled as alarm)
- the signalling of loss of communication to the LAN by a networked controller, both for Master and Slave units

Display of the log

The alarm log is accessed using a password, in the same way as the configuration parameters; the password used is 44.

Description of the alarm log

If the alarm log is empty the display shows three horizontal dashes; otherwise, the following information is displayed:

- the index of the position of the alarm in the log, preceded by a graphic symbol displayed in the highest value digit of the display;
- the alarm code
- the time elapsed in hours (only for units fitted with RTC and configured as Master) from the recording of the event.

For the Slave units, the graphic symbol “_ _” is displayed in the place of the time. The three displays appear in an alternating cycle. The log is scrolled by pressing the arrow buttons:

-  to display the older alarms

-  for more recent alarms.

The size of the log is 9 events.

The alarms appear in the log according to the time of their recording.

At each new alarm event, the older alarms are pushed back in the list. If the log is full, the most recent alarm replaces the oldest event. When an alarm event remains in the log for more than 199 hours its age is replaced by the symbol “_ _”.

NOTE: If the instrument loses its current time value (this may occur if the rechargeable backup battery fitted in the instruments with RTC discharges), the display shows “tC”, and the age of all of the alarm events is replaced by the symbol “_ _”.



On instruments, whose serial number is = 23610, the display of the code “hE” indicates the accidental loss of the alarm log.

Exiting the display of the log

The display of the log is exited either by pressing the  button, or by not pressing any button for 60 seconds.

Deleting the log

The alarm log can be deleted in three ways:

- by carrying out a System Reset;
- on the start-up of the controller, pressing the  and  buttons together for 5 seconds.
- reconfiguring the controller from Master to Slave or vice-versa.

10. New local network functions

10.1 Network defrost for multiplexed systems

The Master controls the defrost in the entire multiplexed island (cabinet controlled by the Master + cabinets controlled by the Slaves). This waits for all units to exit the actual defrost stage before sending the end defrost command to the entire network. The Slaves which have exited the actual defrost stage, await the end defrost command from the Master before passing to the dripping stage. This waiting status is identified on the display by the flashing of the “def” and “fan” LEDs. Once they receive the end defrost command, the Slaves move onto the dripping phase. The actual defrost stage for each individual unit and for the network as a whole end in any case due to timeout. The default end defrost timeout is 30 minutes. The network defrost, which is set to occur cyclically every 8 hours, may also be started manually (pressing the “DEF” + ”SEL” buttons for 5 seconds) or at set times (if the RTC is present). The Master may control and manage the network defrost cyclically, “manually”, by time or via its digital contact, even in operating conditions under which it cannot perform a local defrost.

10.2 Remote alarm signals.

The unit configured as the Master in a multiplexed network may signal remote alarms present in the slave units, if this is enabled, by setting the relative configuration parameter (parameter Ar = 1). All Master units are set to do this as default.

If the Master detects that a Slave unit is in alarm status (regulation probe error, defrost probe error, high/low temperature error, ...) the display shows the signal “nX” (alternating with the display of the temperature), where X (= 1, 2, 3, ... 5), the sub-network address of the Slave in question. Following this event, the alarm relay of the Master is activated, if configured to do so (parameter H1 = 1, or parameter H1 = 2). This allows the use of just one alarm relay (that of the Master) in the multiplexed sub-network. The “nX” signal on

the Master may be inhibited for one minute by pressing  for 1 second.

10.3 The network auxiliary relay.

By default the fourth relay of an MPX unit is configured as the network auxiliary. In a multiplexed network, pressing the  button on the Master propagates the action of the Master's auxiliary relay to all the Slaves with a relay (fan relay or fourth relay) that is configured as an auxiliary (F4 = 2, or H1 = 3). The action of the Master's auxiliary relay is also propagated to the Slaves by a variation (closing/opening of a contact) to the Master's digital inputs (see configuring the digital inputs: parameters A4, A5, A8)

EXAMPLE: in the case of the Curtain Switch, simply connect a switch to the second digital input of the Master (DIN2) so as to be able to also turn on/off the lights on the refrigerated cabinets controlled by the Slave units (the Slaves must be set as F4 = 2, or H1 = 3).

10.4 Configuring a network by “downloading” the parameters from the Master unit.

A Master/Slave network is used to control the temperature of refrigerated cabinets with similar product types. As a consequence, the Master and the Slaves must have the same values for the parameters such as the regulation set-point, the end defrost timeout, the end defrost temperature, the interval between defrosts, the dripping time, etc. All the instruments in the MPX Series feature the possibility of manually configuring just the Master unit, and then transferring the Master's configuration via network to the corresponding Slave units.

The following is a list of the parameters that can be transferred via LAN by the Master to the Slaves:

TABLE OF DOWNLOADABLE PARAMETERS.

CODE	CAUSE
St	Regulation probe Set Point
/4	Virtual probe (%)
/5	Temperature unit of measure
/6	Enable the use of the decimal point in the display of the temperature
/7	Parameter for management of the repeater display and main display
/9	Use third probe for defrost
/A	Flag showing presence or not of defrost probe (defrost with virtual probe)
rd	Control differential
r1	Minimum set temperature allowed to the user
r2	Maximum set temperature allowed to the user
r3	Enable signalling of end defrost due to timeout
r4	Variation in the daytime - night-time set-point and vice-versa
r5	Enable Max and Min temperature monitoring
r6	Enable night-time regulation with the third probe
c0	Delay compressor start-up on controller power up
c1	Minimum time between two successive compressor starts

CODE	CAUSE
c2	Minimum compressor off time
c3	Minimum compressor on time
c4	Compressor on time in Duty Setting mode
cc	Duration of continuous cycle
c6	Exclusion time for low temperature alarm after continuous cycle
d0	Type of defrost
dI	Interval between defrosts
dt	End defrost temperature
dP	Maximum duration of one defrost
d4	Defrost on instrument start-up (YES/NO)
d5	Delay defrost on instrument start-up
d6	No temperature display during defrost
dd	Dripping time
d8	Alarm exclusion time after defrost
d9	Defrost priority over compressor protection
dC	Choice of time base for cyclical defrost and the maximum defrost duration
A0	Fan alarm differential
AH	High temperature alarm upper band
AL	Low temperature alarm lower band
A6	Compressor on time in the case of Duty Setting from external alarm
A7	Delay time in detecting digital input
Ad	Delay in measuring the high and low temperature alarms
F0	Fan management (always on or subject to fan controller)
F1	Fan set-point
F2	Fans off when compressor off
F3	Fans off during defrost
F4	Config. fan relay as AUX if relay 4 is alarm
Fd	Fans off during post-dripping

How to perform a download:

To carry out a download, on the unit configured as Master use the same procedure as for accessing the configuration parameters, and enter the password 66.

The lowest value digit on display of the Master will flash until the end of the download to all the Slave units.

Each Slave, after having been configured by the Master, will perform an auto-reboot.

At the end of the download the lowest value digit on the Master will automatically stop flashing.

Download failed signal:

The Master will display the failure of a download to a Slave by showing the signal (alternating with the temperature) “dX”, where X = 1, 2, ..., 5, that is the value of the parameter “LA” of the Slave for which the operation of configuration via LAN failed.

10.5 Functions available to the RS485 serial supervisory system.

The MPX Series controls can easily be integrated into large supervisory networks by using the MPX models fitted with a built-in RS485 serial interface. These models must be configured as the Master; the units to be integrated must be configured as Slaves, with a maximum of 5 for each Master, which has the function of interface to the RS485 network of the supervisory system. The structure of the software in the MPX provides the supervisory system a number of powerful monitoring and control functions that can be performed on the remote workstation (PC):

- Monitoring of the temperature measured by the three probes on each controller
- Monitoring of the status of the digital inputs of each instrument
- Monitoring of the alarms on all the controllers, including the Slaves, which are not directly connected to the RS485 serial communication channel
- Reading and modification of the value of the parameters of each controller, including the Slaves, which are not directly connected to the RS485 serial communication channel
- Remote control of the controllers' actuators (light relay) for an entire locked-out multiplexed island
- Remote control of the light relays for each individual MPX unit
- Network defrost for a multiplexed island by Supervisory units
- Defrost of any remote unit belonging to a multiplexed island
- Switching OFF of any MPX by a Supervisory unit
- Activation of alarm signals and associated operating mode (Duty Setting) from the Supervisory system.

11. DESCRIPTION OF THE CONFIGURATION PARAMETERS

11.1 Configuration parameters

As already mentioned, (see chapter on how to modify the operating parameters), there are two types of parameter:

- parameters used frequently (indicated by 'F' in the following tables)
- configuration parameters (type C), which are protected by a password to prevent unwanted modification.

11.2 Parameter categories



Besides being divided into TYPES, the parameters are grouped into logical categories labelled by letters indicating their function. The categories and their identifying letters are given below:



Category	Description
Flashing 00	Does not indicate a category, but merely that a password must be entered in order to access the configuration parameters or the alarm log.
/	parameters corresponding to temperature probe;
r	parameters corresponding to temperature control;
C	parameters corresponding to compressor management;
d	parameters corresponding to defrost management;
A	parameters corresponding to alarm management;
F	parameters corresponding to evaporator fan management;
H	general parameter configuration;

11.3 The password

FLASHING PASSWORD:

This is a protective device that intentionally "complicates" access to Configuration parameters in order to prevent accidental changes or any that might be made by unauthorised persons. Type C parameters are in fact those that alter the controller's configuration. Once the configuration parameters have been entered via the use of the password, the system also allows the user to alter type F parameters as required

The password request (flashing 00) appears when the two buttons  and  are pressed at the same time. Access to type C parameters is gained as follows:

- press  or  to enter 22 or the correct password;
- confirm using ;
- the code of the first modifiable parameter is displayed, that is 'C'.
- enter 44 as the password, if you wish to access the alarm log
- enter 66 as the password on a Master unit if you wish to download the parameters from the Master to its Slaves, for the configuration of a multiplexed island

The following paragraphs describe all the parameters.

In addition, the **default value** (Def.), that is the value set in the factory, will also be indicated.

11.4 / = parameters for the management of the temperature probes

/	PROBE PARAMETER	Type	Min	Max.	UOM	Def.	To LAN	New
St	Temperature set-point		r1	r2	°C/°F	-10.0	•	
/C	Regulation probe calibration	F	-20	+20	°C/°F	0.0		
/2	Measurement stability	C	1	15	-	1		
/3	Probe reading rate	C	1	15	-	1		
/4	Virtual probe (between probe 1 and probe 3) (0 = probe 1; 100 = probe 3)	C	0	100	-	0	•	
/5	°C/°F (0 = °C; 1 = °F)	C	0	1	flag	0	•	
/6	Decimal point enabling (0 = No, 1 = Yes)	C	0	1	flag	0	•	
/7	Display on main display and repeater 0 = repeater not present 1 = 3rd probe reading only on repeater 2 = 3rd probe reading also on main display 3 = virtual probe reading on the main display and defrost probe on repeater	C	0	3	flag	0	•	
/8	3rd probe calibration	C	-20	+20	°C/°F	0.0		
/9	Defrost with probe 3 1 = the defrost in temperature ends when the temperature measured by probe 3 is \geq the temperature set for parameter "dt"	C	0	1	flag	0	•	
/d	Defrost probe calibration	C	-20	+20	°C/°F	0.0		

Short descriptive note about probes with NTC- and PTC-type thermistors:

Units in the MPX series are designed to work with Carel NTC temperature probes, or probes using thermistors with a negative characteristic (NTC stands for Negative Temperature Coefficient). This type of thermistor modifies an electrical parameter (its own resistance) in inverse proportion to any change in temperature; that is, the resistance falls as the temperature rises, and vice versa. Other types of thermistor are on the market. PTC thermistors are widely available, with a resistance of 985 Ohms at 25°C. PTC stands for Positive Temperature Coefficient; by contrast with the NTC, these increase their resistance directly as the temperature increases. As can be seen in the diagram below, (the horizontal axis represents the operating range, the vertical axis the error), the NTC type of probe shows greater accuracy than the PTC version. This is why the NTC probes have been adopted as standard.

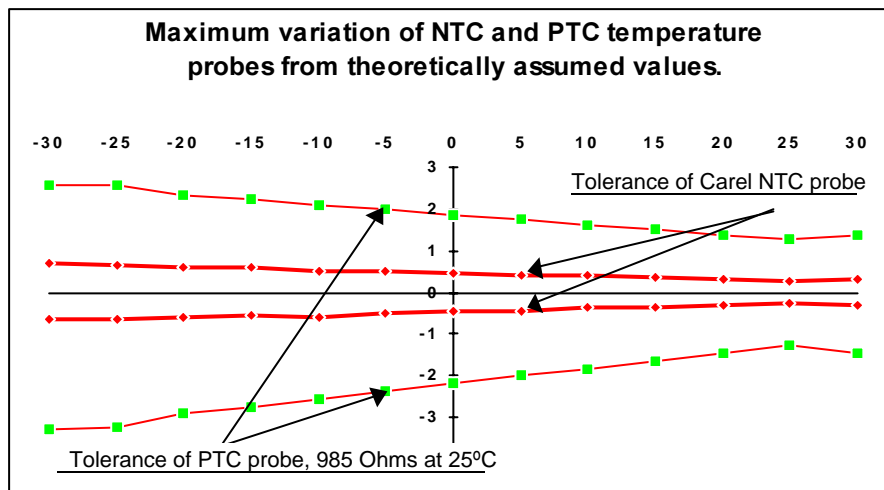

/C: Calibration Offset for the ambient probe (probe S1)

The value assigned to this parameter is added to (if positive) or subtracted from (if negative) the temperature transmitted by the probe S1. For example, to reduce the temperature displayed by 2.3 degrees, /C should be set to -2.3. The calibration offset can be varied from -20 to +20 with precision to a tenth of a degree, from -19.9 to +19.9.

- Available on all models

- Default is 0.0, i.e. no offset is applied to the probe's reading.

/2: Stability of measurement

This parameter is used to control the stability with which the temperature is measured. Low values assigned to this parameter produce a prompt response by the probe to variations in temperature; however, the display becomes correspondingly sensitive to changes. High values slow down the response, causing less fluctuation and a more stable reading.

- Available on all models.
- Default value is 1.

/3: Probe reading speed

Establishes the maximum variation in the measurement of the temperature for each complete analogue input acquisition cycle. Small values of this parameter restrict the variation in temperature within the short period, and thus reduce the unit's susceptibility to erratic impulses

Note: When modifying both this parameter and the previous, operate in a consistent manner: that is, if /2 is increased, /3 should be left unchanged or reduced. Vice-versa if /2 is decreased.

- Available on all models.
- Default value is 1.

/4: Virtual probe

Defines a fictitious probe, which does not exist physically, used for normal regulation operations. This parameter determines the weighted average used to calculate the value of the virtual regulation probe based on the readings from the ambient probe (S1) and probe S3 (cabinet hot point). The formula is the following:

$$\text{virtual probe} = \frac{(100 - ("/4")) \times S1 + ("/4") \times S3}{100};$$

With a value of 0 the virtual probe coincides with the ambient probe; with a value of 100 the virtual probe coincides with probe 3.

- Parameter can be transferred via LAN from the Master to its connected Slaves.
- Available on all models
- Def.: 0.

/5: Selection of °F or °C

Defines the unit of measurement.

- 0 = for working in degrees Celsius,
- 1 = for working in degrees Fahrenheit.

When passing from one unit to another, the unit of measure for the set-point and the regulator differential are also automatically changed.

- Parameter can be transferred via LAN from the Master to its connected Slaves.
- Available on all models
- Def.=0, operation in degrees Celsius.

/6: Decimal point

Allows the display of temperature with or without tenths of degrees ranging from -19.9 to +19.9.

- 0= data displayed with tenths of degrees;
- 1= data displayed without tenths of degrees.

- Parameter can be transferred via LAN from the Master to its connected Slaves.
- Available on all models
- Def.: 0, decimal point enabled.

/7: Reading on main display and repeater

Allows the selection of the readings on the repeater and the main display

- 0 = repeater not present; default value
- 1 = third probe reading on repeater
- 2 = third probe reading also on the main display
- 3 = second probe reading (defrost probe) on repeater

- Parameter can be transferred via LAN from the Master to its connected Slaves.
- Available on all models
- Def.: 0, external display not present.

/8: Calibration of the third probe (cabinet hot point)

The value assigned to this parameter is added to (positive value) or subtracted from (negative value) the temperature measured by probe S3. For example, to reduce the temperature by 2.3 degrees /8 must be set to -2.3. The offset may range from -20 to +20, with decimal precision between -19.9 and +19.9.

- Available on all models
- Def.: 0.0 (no offset to probe reading)

/9: defrost with probe 3

This parameter allows a defrost to be carried out using probes S2 and S3 together, if set to 1. In this case the temperature defrost ends when the temperature measured by both probes is greater than or equal to that set as the end defrost temperature (See parameter “dt”). Probe 3 can therefore be used as a defrost probe on a second evaporator.

- Parameter can be transferred via LAN from the Master to its connected Slaves.
- Available on all models
- Def.: 0. Temperature defrost with probe S2 only (one evaporator only)

/d: Calibration of the second probe (S2: defrost probe)

The value assigned to this parameter is added to (positive value) or subtracted from (negative value) the temperature measured by probe S2. For example, to reduce the temperature by 2.3 degrees /8 must be set to -2.3. The offset may range from -20 to +20, with decimal precision between -19.9 and +19.9.

- Available on all models
- Def.: 0.0 (no offset to probe reading)

/A: Presence of probes S2 and S3 (defrost and hot point)

The value of this parameter tells the instrument if the defrost probe (S2) and/or cabinet hot point probe (S3) are connected or not. The possible values for this parameter are the following:

- 0 = defrost probe and third probe absent
- 1 = defrost probe absent and probe 3 present
- 2 = defrost probe present and probe 3 absent
- 3 = defrost probe and probe 3 both present

Examples:

- I) If probe S2 is not present set “/A = 0” or “/A = 1”. The instrument will in this way be informed that probe S2 has not been wired during pre-installation and will use probe S1 to manage any temperature defrosts. The absence of probe S2 will not generate any error signals.
 - II) If probe S3 is not present set “/A = 0” or “/A = 2” : this will avoid the signalling of the “rE” regulation error due to the detected disconnection of probe S3 (that is an error due to the malfunctioning of one of the two probes which together determine the value of the virtual probe).
- Parameter can be transferred via LAN from the Master to its connected Slaves.
 - Available on all models
 - Def.: 3; probes S2 and S3 both present

11.5 r = parameters for temperature regulation

r	REGULATION PARAMETERS	Type	Min	Max.	UOM	Def.	To LAN	New
rd	Regulator differential (hysteresis)	F	0.1	+20	°C/°F	2.0	•	
r1	Minimum set allowed to the user	C	-50	r2	°C/°F	-50	•	
r2	Maximum set allowed to the user	C	r1	+199	°C/°F	90	•	
r3	Ed alarm enabling (defrost interrupted for timeout) 0 = No, 1 = Yes	C	0	1	flag	0	•	
r4	Automatic variation of the night-time set-point (curtain switch closed)	C	-20	+20	°C/°F	3.0	•	
r5	Enable min. and max. temperature monitoring	C	0	5	flag	0	•	
r6	Night-time variation with third probe (1 = night with curtain lowered, regulation with probe 3; 0 = night regulation with the virtual probe)	C	0	1	flag	0	•	
rt	Min. and max. temperature measuring interval	F	0	199	hours	-		
rH	Max. temperature measured in the interval “rt”	F	-	-	°C/°F	-		
rL	Min temperature measured in the interval “rt”	F	-	-	°C/°F	-		

rd: Regulation delta

Sets the value of the differential, or hysteresis, used in regulating the temperature. A narrow differential, i.e. one with a low number, ensures a temperature that differs little from the set-point (or optimal operating temperature), but one that requires the frequent switching on and off of the main operating components (normally the compressor). It is possible to extend the life of the compressor by appropriately setting the parameters to define the number of start-ups per hour and the minimum off period (see the Compressor parameters).

In all MPX refrigeration units the differential is placed to the right of the set-point as indicated below (DIRECT operation):

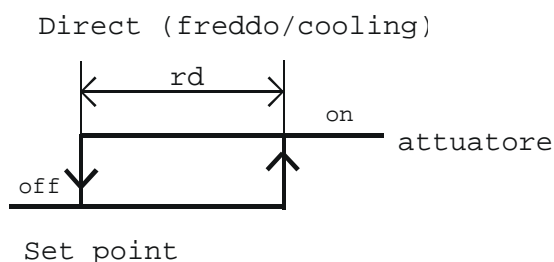

- Parameter can be transferred via LAN from the Master to its connected Slaves.

- Available on all models

- Def.: rd=2.0

r1: Minimum set allowed

This parameter establishes the minimum value that can be given to the set-point. Using this parameter prevents the user from setting a set-point lower than the value assigned to r1

- Parameter can be transferred via LAN from the Master to its connected Slaves.

- Available on all models

- Def.: -50

r2: Maximum set allowed

This parameter establishes the maximum value accepted as a set-point. Use of this parameter prevents the user from setting a set-point greater than the value assigned to r2

- Parameter can be transferred via LAN from the Master to its connected Slaves.

- Available on all models

- Def.: +90

r3 : enable signalling of end defrost for timeout

enables alarm "Ed": defrost ended due to timeout.

0 = alarm disabled

1 = alarm enabled

- Parameter can be transferred via LAN from the Master to its connected Slaves.

- Available on all models

- Def.: 0

r4: set-point variation by digital input

automatic set-point variation by digital input: day/night set-point

The parameter r4 ranges from -20 to +20 degrees with decimal resolution. When configured, on the closing of a digital input the set-point varies by the amount stored in parameter "r4".

- Parameter can be transferred via LAN from the Master to its connected Slaves.

- Available on all models

- Def.: 3.0

r5: enable temperature monitoring (maximum and minimum)

Enables the monitoring of the max ("rH") and min ("rL") temperatures in the interval "rt" (max 199h).

r5	Enable min. and max. temperature monitoring	Temperature alarm monitoring (HI and LO)
0	None	On virtual probe
1	On probe S1	On virtual probe
2	On probe S3 (only if /7 = 1)	On virtual probe
3	None	On probe S3
4	On probe S1	On probe S3
5	On probe S3 (only if /7 = 1)	On probe S3

Monitoring begins when "r5" is assigned a value greater than or equal to 1.

To inhibit monitoring and/or reset the values recorded, set “r5” to 0. After 199 hours the measuring of the max. and min. temperatures is halted, having reached the maximum monitoring time allowed by the instrument. Modify “r5” to perform monitoring again (first set to 0 using the arrows and the SEL button and then to the required value between 1 and 5, again using the arrows and SEL. Press PRG to save.).

In the event of blackouts, keypad resets or Off commands from digital input, monitoring will be reset and then start from zero when the same conditions as described above are true.

- Parameter can be transferred via LAN from the Master to its connected Slaves.

- Available on all models.

- Def.: r5=0; temperature monitoring not enabled.

r6: night-time regulation with third probe

if regulation is performed using the night-time set-point, regulation can be selected using either the virtual probe or the third probe only (cabinet hot point):

r6 = 1: night-time regulation using probe S3

r6 = 0: night-time regulation using the virtual probe

- Parameter can be transferred via LAN from the Master to its connected Slaves.

- Available on all models

- Def.: 0; regulation using virtual probe

rt: temperature monitoring time

once temperature monitoring has been enabled the time in hours from the start of the monitoring period is saved for this parameter.

- Available on all models

- Def.: - ;

rH: maximum temperature measured in time “rt”

once temperature monitoring has been enabled the maximum temperature measured from the start of the monitoring period is saved for this parameter.

- Available on all models

- Def.: - ;

rL: minimum temperature measured in time “rt”

once temperature monitoring has been enabled the minimum temperature measured from the start of the monitoring period is saved for this parameter.

- Available on all models

- Def.: -

11.6 c = parameters for compressor management

c	COMPRESSOR PARAMETERS	Type	Min	Max.	UOM	Def.	To LAN	New
c0	Compressor start delay when the instrument is turned ON	C	0	15	min	0	•	
c1	Minimum time between two successive compressor starts	C	0	15	min	0	•	
c2	Minimum compressor off time	C	0	15	min	0	•	
c3	Minimum compressor on time	C	0	15	min	0	•	
c4	Relay safety (0 = compressor always OFF, 100 = compressor always ON)	C	0	100	min	0	•	
cc	Continuous cycle duration	C	0	15	hours	4	•	
c6	Low temp. alarm exclusion-time after continuous cycle	C	0	15	hours	2	•	

c0: Delay in switching on the compressor and fans (if controlled) after switching on the instrument

From when power is supplied to the controller, the start-up of the compressor is delayed by a time (in minutes) equal to the value assigned to this parameter. This delay serves to protect the compressor from repeated start-ups when there are interruptions to the power supply. For example, setting c0=6 the compressor will wait 6 minutes before starting from when power is supplied. In the case of systems with more than one compressor, the parameter “c0” may also be used to prevent the simultaneous starts of the units. In this case a different value of “c0” should be set for each compressor.

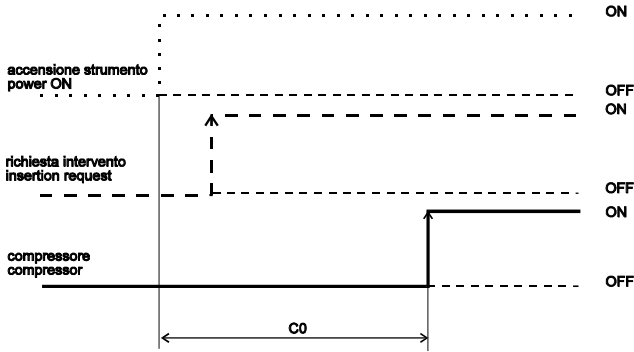

- Parameter can be transferred via LAN from the Master to its connected Slaves.
- Available on all models
- Def.: c0=0 (no delay is set for the activation of the compressor following the start-up of the instrument).

c1: Minimum time between two compressor starts

This sets the minimum time in minutes that must elapse between two starts of the compressor, independently of the temperature and of the set-point. By setting this parameter it is possible to restrict the number of starts per hour. For example, if the greatest number of starts permitted in an hour is 10, simply set c1=6.

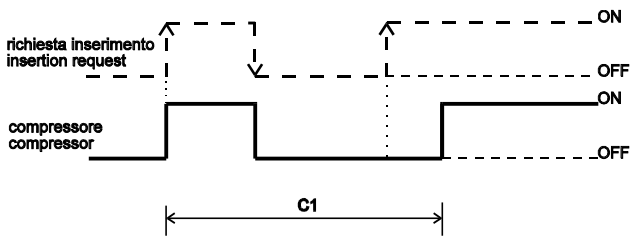

- Parameter can be transferred via LAN from the Master to its connected Slaves.
- Available on all models
- Def.: c1=0 (no minimum time is set between two start-ups)

c2: Minimum compressor OFF time

This sets the minimum time in minutes for which the compressor may remain inactive. The compressor will not be started if the minimum time selected has not elapsed (c2). This parameter is useful for equalising pressure after switch-off in the case of installations with hermetic and capillary compressors

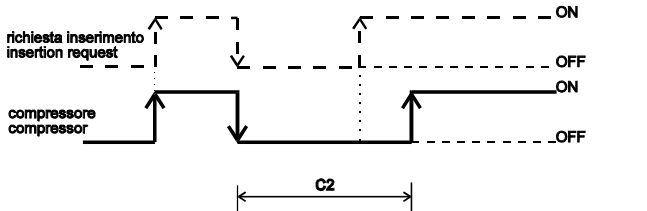

- Parameter can be transferred via LAN from the Master to its connected Slaves.
- Available on all models
- Def.: c2=0 (no minimum OFF time is set)

c3: Minimum compressor ON time

This sets the shortest period for which the compressor may operate. The compressor will not be switched off if it has not been on for a time equivalent to the minimum selected

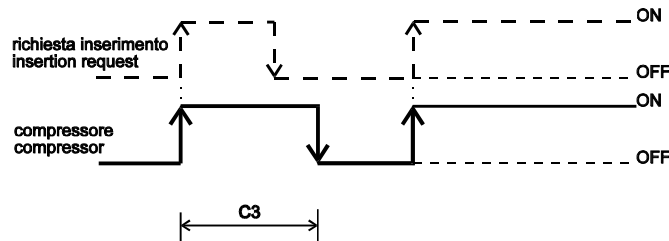

- Parameter can be transferred via LAN from the Master to its connected Slaves.
- Available on all models
- Def.: c3=0 (no minimum ON time is set)

c4: Duty setting or safety relay

If the “regulation error” alarm occurs (that is, probes S1 and/or S3 are short-circuited or disconnected) this parameter ensures the operation of the compressor until of the elimination of the fault. As the compressor is unable to function based on the temperature (because of the faulty probe), it is activated cyclically with an operating time (“ON time”) in minutes equivalent to the value assigned to c4 and a fixed OFF time of 15 minutes.

There are two values of c4 that produce special functions.

If c4=0, the compressor will remain permanently OFF in the case of a defective probe

if c4=100, the compressor will remain permanently ON, the 15-minute off-time being cancelled.

The following particular situations should also be considered:

if the regulation error occurs while the compressor is off, it is turned on (respecting the delays set by parameters “c1” and “c2”), and remains on for a time equal to “c4”. This is called “duty setting” operation, which is signalled by the "COMP" LED that flashes during compressor off period and stays on when the compressor is in operation. The fans continue to operate according to their respective parameters (see F parameters). If the probe fault alarm is signalled while the compressor is operating, the compressor is switched off (without regard to the minimum operating time which may have been selected under parameter c3), and remains off for 15 minutes; (the "COMP" LED flashes during this phase). After this, periodic operation commences according to the operating time set under c4. If the probe fault alarm is signalled while the system is in defrost or in continuous cycle, control immediately exits from the current state and duty setting starts. To re-activate the defrost or continuous cycle operation, a back-up operation can be performed by modifying parameter “/A”, assigning it values 0 or 2 (third probe not present). If the error disappears, the machine returns to normal operation (regulation). If the error persists even after this operation, the correct operation of both probes S1 and S3 must be checked by opening the panel and checking the electrical connections. Please keep in mind that, in the case of a regulation error on a Master/Slave unit, neither manual defrosts nor continuous cycle can be performed. A Master which shows a regulation error may, on the other hand, manage the defrosts of all its Slaves (network defrost).

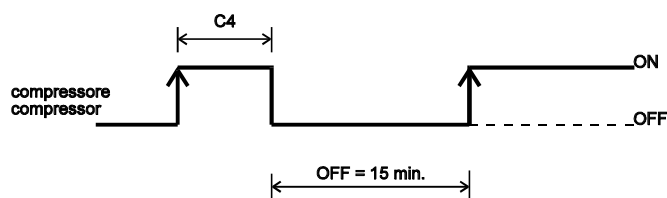

- Parameter can be transferred via LAN from the Master to its connected Slaves.

- Available on all models

- Def.: 0 (compressor always off in the case of faulty ambient probe).

Cc: duration of the continuous cycle

The period in hours for which the compressor remains in operation so as to lower the temperature even below the set-point. If cc=0, the continuous cycle is not activated. Control exits from continuous cycle mode when the period set under parameter cc has elapsed, or when the minimum set temperature has been reached: (set-point - AL)

- Parameter can be transferred via LAN from the Master to its connected Slaves.

- Available on all models

- Def.: 4 (hours)

c6: Alarm cut-out after continuous cycle operation

The time, in hours, that the low temperature alarm is no longer monitored after a continuous cycle. In practice, if the temperature of the refrigerated unit, following a continuous cycle, falls due to inertia below the minimum temperature (set-point - AL) the monitoring of the relative alarm is delayed by the time c6. In theory, the persistence of the conditions for a low temperature alarm, at the end of a continuous cycle, can be detected after a time equal to the sum of “c6” hh + “Ad ” mm (parameter “Ad”: delay in minutes for the signalling of low/high temperature alarm). Please remember that at the minimum temperature (set-point - AL), the continuous cycle is deactivated.

- Parameter can be transferred via LAN from the Master to its connected Slaves.

- Available on all models

- Def.: 2 (hours)

11.7 d = Parameters for defrost management

d	DEFROST PARAMETERS	Type	Min	Max.	UOM	Def.	To LAN	New
d0	Defrost types 0 = electrical: ends by temperature and/or for timeout 1 = hot gas: ends by temperature and/or for timeout 2 = electrical: ends for timeout 3= hot gas: ends for timeout	C	0	3	-	0	•	
dI	Interval between two defrosts (activated for defrosts without RTC)	F	0	199	hours	8	•	
dt	Defrost end temperature	F	-50	+199	°C/°F	4	•	
dP	Maximum defrost time	F	1	199	min	30	•	
d4	Defrost when the instrument starts (0 = No, 1 = Yes)	C	0	1	flag	0	•	
d5	Defrost delay when instrument starts or from digital input	C	0	199	min	0	•	
d6	Main display and repeater during defrost: 0 = No display block and the temperature alternates with the “dF” symbols on both displays 1 = display is blocked on both displays 2 = “dF” on both displays ¹	C	0	2	flag	1	•	
dd	Dripping time after defrost	F	0	15	min	2	•	
d8	High temperature exclusion time after defrost and if (A4 = 5, A5 = 5 or A8 = 5) alarm exclusion time from the opening of the door	F	0	15	hours	1	•	
d9	Defrost priority over compressor protection (0 = No, 1 = Yes)	C	0	1	flag	0	•	
d/	Defrost probe display (S2)	F	-	-	°C/°F	-		
dA	Third probe display (S3)	F	-	-	°C/°F	-		
dC	Time base for the intervals between defrosts and maximum duration (dP) (0 = hours/mins; 1 = mins/secs)	C	0	1	flag	0	•	

d0: Type of defrost

This parameter sets the type of defrost for units fitted with defrost relays:

0 = electrical heating element : ends at temperature and/or for timeout

1 = hot gas : ends at temperature and/or for timeout

2 = electrical heating element : ends for timeout

3= hot gas : ends for timeout

- Parameter can be transferred via LAN from the Master to its connected Slaves.

- Available on all models

- Def.: d0=0, electrical defrost, temperature end

dI: Interval between cyclical defrosts

The parameter “dI” manages the so-called "cyclical" defrosts for of each individual Master/Slave unit. These are controlled by a timer, built-into the instrument, with a set value (in hours / minutes: see parameter “dC”) saved for parameter “dI”. This timer is reset after each attempted defrost (including non-cyclical ones). If the time “dI” is set to 0 (dI=0) no cyclical defrosts are performed. Cyclical defrosts may be local (that is, performed independently on the individual units), or network: after the time “dI” on a Master with connected Slaves, the Master will manage a network defrost. During the defrost the temperature alarms are disabled.

Parameter can be transferred via LAN from the Master to its connected Slaves.

- Available on all models

- Def.: 8 hours

¹ (*) Only the new repeaters with updated FW allow the display of the codes besides the temperature; the others, if d6 = 2, display only one fixed temperature.

dt: End defrost temperature set-point

This parameter allows the setting of the temperature of the evaporator at which the defrost is ended (the temperature of the evaporator is measured by the defrost probe: probe 2). If at the start of a defrost ($d0 = 0$) the temperature measured by the defrost probe is greater than the set end defrost temperature, the unit goes directly to the dripping phase (See further on, network defrost). In the case of malfunction of the defrost probe, the controller will effect a defrost lasting for a period equivalent to the value set for dP. Thus if the end defrost set-point can not be reached, the defrost will be interrupted after a maximum period equivalent to the value in minutes of dP, and the Ed error will be displayed (if $r3 = 1$) **and will persist until a defrost is “correctly” performed, that is, ends at the set temperature.** In the case where probe S3 is used as a defrost probe on a second evaporator, the temperature defrost ends when both probes, S2 and S3, measure a temperature above or equal to that set in parameter “dt”.

- Parameter can be transferred via LAN from the Master to its connected Slaves.

- Available on all models

- Def.: 4

dP: Maximum defrost duration

Determines the duration of the defrost in minutes (or seconds, see parameter dC) for timed defrost. In the case where, during a temperature defrost, the end defrost temperature is not reached within the time “dP”, “dP” represents the maximum duration of the defrost.

- Parameter can be transferred via LAN from the Master to its connected Slaves.

- Available on all models

- Def.: 30 minutes

d4: Defrost at power ON

Activates a defrost when the unit is switched on. Possible values are:

0 = no defrost on start-up of the units;

1 = defrost is effected on start-up.

Commanding a defrost when the unit is switched on can be useful in certain particular situations, for example if the installation suffers from frequent blackouts. If there is a power failure, the internal clock that calculates the intervals between two defrosts will be set to zero. In extreme cases, if the frequency of power failures is greater than the frequency of defrosts (for example, a power failure every 8 hours with a defrost interval of 10 hours), the controller would never command a defrost. In such a situation, it is better to activate defrost at power on, especially if defrost is set by temperature (evaporator probe) so as to avoid unnecessary defrosts or at least reduce the duration of such.

In the case of multi-unit installations, if defrost at power-on is chosen, when power is restored all the units may start defrosting at the same time, and therefore the power supply will be overloaded. To avoid this, use parameter d5, which allows an initial delay in defrost; this delay obviously has to set to a different value for each unit

- Parameter can be transferred via LAN from the Master to its connected Slaves.

- Available on all models

- Def.: $d4=0$, the instrument does not perform a defrost on start-up.

d5: Delay of defrost at power-on or start of Multi-function

This parameter sets the time that is to elapse between the controller power on and the start of defrost. When a digital input is used, either to start a defrost (see parameter A4/A5/A8 =3) or to convey a defrost command from an external contact (see parameter A4/A5/A8 =4), this parameter represents the delay between the defrost start command and its actual start. The digital input for defrost (see parameter A4/A5/A8) can be used to carry out defrosts in real time. Simply connect a timer to the multifunction digital input (see parameter A4/A5). The defrost will be activated when the timer contacts close. Where several units are connected to the same timer, use parameter d5 to delay the various defrosts, so as to avoid overloading the power supply. Furthermore, to avoid unwanted defrosts being commanded by the unit's internal clock, parameter dI should be set to 0 on all the units, and timed defrosts should be disabled on all units configured as Master and fitted with RTC (defrosts only from keypad or from multi-function contact).

- Parameter can be transferred via LAN from the Master to its connected Slaves.

- Available on all models

- Def.: $d5=0$ (no delay in defrost from the start-up of the instrument or the activation of the multifunction input)

d6: Management of the instrument's display and the repeater during defrost

There are 3 options:

0 = Display not locked-out and temperature reading alternates with the symbol “dF” on both displays

1 = Both displays locked at the last value displayed before of the start of the defrost

2 = “dF” fixed on both displays

Readings normally return to both displays after the post-dripping phase (under normal regulation). Repeaters belonging to older models do not manage the display of symbols; for these, $d6 = 1$ and $d6 = 2$ represent the same setting.

- Parameter can be transferred via LAN from the Master to its connected Slaves.

- Available on all models

- Def.: $d6=1$ (during defrost the last temperature measured before the start of the defrost remains on the display)

dd: Dripping time

This parameter makes it possible to shut down the compressor and the evaporator fans after a defrost, so as to speed up the dripping from the evaporator. The value of the parameter indicates the minutes of shut-down. If dd=0, no dripping time is provided for, with the result that the compressor will be re-activated immediately when defrost ends.

- Parameter can be transferred via LAN from the Master to its connected Slaves.
- Available on all models
- Def.: dd=2 minutes

d8: Period of alarm cut-out after defrost and/or open door

This indicates the time for which a high temperature alarm will be inhibited at the end of a defrost and/or after the door of a store-room has been opened, in the case of the Multi-function input being connected to the door-switch (see parameter A4/A5).

- Parameter can be transferred via LAN from the Master to its connected Slaves.
- Available on all models
- Def.: d8=1 hour of cut-out

d9: Defrost priority over compressor protection

This parameter cancels the compressor protection times (c1: minimum time between two successive start-ups, c2: minimum shut-down time and c3: minimum operating time) at the start of defrost.

- 0= protection times are observed;
 - 1= protection times are not observed; defrost has greater priority and takes no account of the compressor timings.
- As an example, this is useful for avoiding a delay in the hot gas defrost when the compressor has just stopped and has been restarted with a minimum time between two starts. It must be remembered, however, that in this event the maximum number of compressor starts per hour may not be observed.
- Parameter can be transferred via LAN from the Master to its connected Slaves.
 - Available on all models
 - Def.: d9=0 the defrost follows the compressor times (by default these are set to zero).

D/: Defrost probe reading

This parameter displays the value being read by the defrost probe, in the units where it is fitted. When the parameter d/ has been

- selected, pressing  will not allow the value to be changed, but the value recorded by the defrost probe can be read.
- Available on all models

dA: Third probe reading

This parameter displays the value read by the defrost probe, where fitted. Once the parameter dA has been selected, pressing  does not allow the modification of the value but rather the reading of the temperature measured by the third probe (S3).

- Available on all models

dC: Time bases

Changes the units of measure used to count the times for parameters dI (interval between defrost) and dP (duration of defrost).

- 0 = dI is expressed in hours and dP in minutes;
 - 1 = dI is expressed in minutes and dP in seconds.
- The parameter dC=1 can be useful for quickly testing the defrost operation with reduced times. It is however considered that if defrost requires the activation of the compressor (hot gas defrost) and the parameter d9=1, there may be a risk of damaging the compressor by too many starts at short intervals. The defrost cycle thus becomes the condensate discharge cycle, which needs to be started at short intervals (minutes) and for very brief periods (seconds). Contact your Carel agent for further information.
- Parameter can be transferred via LAN from the Master to its connected Slaves.
 - Available on all models
 - Def.: dC=0, that is, defrost interval, in hours and dP, maximum defrost duration, in minutes.

11.8 A = parameters for alarm control

A	ALARM PARAMETERS	Type	Min	Max.	UOM	Def.	To LAN	New
A0	Fan and alarm differential	C	0.1	+20	°C/°F	2.0	•	
AH	High temperature alarm: indicates the maximum variation from the set-point. AH = 0 excludes the high temperature alarm	F	0	+199	°C/°F	4	•	
AL	Low temperature alarm: indicates the maximum variation from the set-point. AL = 0 excludes the low temperature alarm	F	0	+199	°C/°F	4	•	
A4	Digital input no.1 configuration (*)	C	0	7	-	0		
A5	Digital input no.1 configuration (*)	C	0	7	-	0		
A6	Compressor stop (set Duty Setting from external alarm: A4 = 1 or 2; a5 = 1 or 2); 0 = compressor always OFF 100 = compressor always ON	C	0	100	min	0	•	
A7	Detection delay time for the “ <i>delayed alarm</i> ” input (A4 = 2, or A5 = 2)	C	0	199	min	0	•	
Ad	Temperature alarm delay	C	0	199	min	120	•	
A8	Configuration of the instrument’s virtual digital input	C	0	7	-	0		
A9	Enable propagation via LAN of the second digital input on the Master (1 = propagation, 0 = no propagation)	C	0	1	flag	1		
Ar	Enable remote alarm signals from Slaves on the Master (1 = remote alarm signals enabled)	C	0	1	flag	1		

A0: Alarm and fan differentials

This parameter represents the differential used for activating the high and low temperature alarms (AL and AH – see the diagram below) and for the control of the fans (see F parameters). In the case of the alarms, as can be seen from the diagram, the value A0 contributes to determining the points at which the temperature alarms actually occur.

- Parameter can be transferred via LAN from the Master to its connected Slaves.
- Available on all models
- Def.: 2.0 degrees

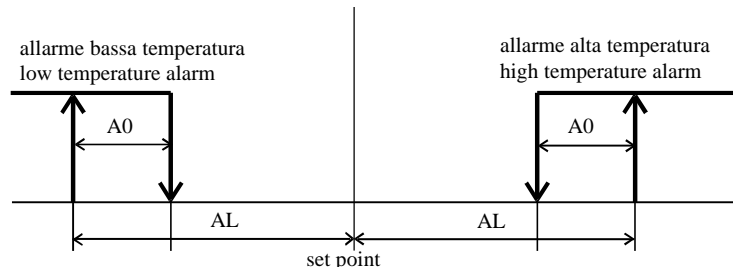

AH: High temperature alarm

It allows the high temperature alarm to be set. The value of AH does not indicate the temperature at which the alarm is given, **but rather the maximum deviation allowed from the set-point** (i.e. the requested operating temperature). Therefore:

$$\text{High temperature alarm} > (\text{set point}) + (\text{value of AH})$$

Note that changing the set-point automatically changes the high temperature alarm, while the maximum deviation permitted remains the same. The end of the alarm condition occurs when:

$$\text{temperature} \leq (\text{set point}) + (\text{value of AL}) - (\text{value of A0})$$

The end of the alarm condition automatically cancels the corresponding signal. The re-occurrence of the alarm condition returns the instrument to monitor the condition itself.

- Parameter can be transferred via LAN from the Master to its connected Slaves.
- Available on all models
- Def.: AH=4

AL: Minimum temperature alarm

This parameter allows the low temperature alarm to be selected. The value of AL does not indicate the temperature at which the alarm will sound, **but rather the maximum deviation from the set-point** (i.e. the requested operating temperature) that is permitted.

The low temperature alarm is given as follows:

$$\text{Low temperature alarm} < (\text{set point}) - (\text{value of AL})$$

Note that changing the set-point automatically changes the temperature at which the low temperature alarm will be given, while the maximum differential permitted (AL) remains as set. The end of the alarm condition occurs when:

$$\text{temperature} \geq (\text{set point}) - (\text{value of AL}) + (\text{value of A0})$$

The end of the alarm condition automatically cancels the corresponding signal. The re-occurrence of the alarm condition returns the instrument to monitor the condition itself. It should be remembered that the low temperature alarm is also used in the continuous cycle (see relative section). In fact, if the temperature falls to the level set for the alarm, the continuous cycle is automatically stopped, even if the set period of time has not elapsed. The stopping of the cycle does not lead to any alarm signal.

- Parameter can be transferred via LAN from the Master to its connected Slaves.

- Available on all models

- Def.: AL=4

Ad: Temperature alarm delay

Indicates the delay in minutes before a registered deviation is signalled. The measuring of a temperature alarm condition leads to the monitoring of the condition itself for a time equal to "Ad" minutes, after which, if the condition persists, the alarm is signalled. If there is an end to the alarm condition within the period "Ad", no alarm is signalled.

Setting a delay in signalling temperature alarms can help to avoid false alarms due to interference with the probe or situations lasting only a limited time, such as briefly opening the door of a store-room.

Alarm delays do not affect two particular functions: defrost and continuous cycle. To delay any temperature alarms after these functions, parameters d8 for defrost and c6 for continuous cycle must be set. Remember that temperature alarms are not generated during defrost and continuous cycle operation.

- Parameter can be transferred via LAN from the Master to its connected Slaves.

- Available on all models

- Def.: Ad=120 (120 minutes' delay in signalling temperature alarms).

11.9 Digital inputs and description of the interface commands for the supervisor.

A4/ A5 / A8: Configuration of the Multi-function digital inputs

The instruments in the MPX Series are fitted with three digital inputs, which can be configured using parameters A4, A5, A8. Parameters A4 and A5 configure the digital inputs DIN1 and DIN2, which are wired during pre-installation.

All units (both Master and Slave) can also manage, using an electrical analogy, a "third digital input", known as the "virtual" input: This input in the unit Slave is "physically" supported by the terminals in the LAN, while for the units configured as Masters and fitted with RS 485 serial connection, it is supported by the signal terminals (+ and -) of the RS485.

In the case of a multiplexed network (Master + Slave), the virtual digital inputs for all the instruments are "wired" in parallel. The virtual inputs of the Slave are served by the Master and that of the Master is served by the supervisory system. The physical input DIN2 of the Master may also be "wired" in parallel to the virtual inputs, by setting (on the Master unit) the parameter A9. In this case the closing/opening of the physical contact DIN2 on the Master will be propagated to the "virtual digital" inputs on all the connected Slave units (as by default happens for the Master's "virtual digital" input).

The parameter A8 configures the "virtual digital" input of a MPX.

Note that this is used only as an analogy: do not physically connect external switches to the LAN and RS485 inputs to access the functions associated with the virtual digital input!!!

The following is a description of the functions for each value of A4/A5/A8:

A4/A5/A8 = 0: corresponding input not active

The Multifunction digital input is not used and is insensitive to variations (closing/opening) of any externally-connected contacts.

A4/A5/A8 = 1: input associated to immediate external alarm

It is possible to connect the digital input to an external alarm, which will request immediate intervention (for example a high pressure or compressor temperature alarm). In particular, the alarm is registered when the contact is opened (normal operation being in the closed state).

Activation of the alarm produces a display signal (see alarm A1), the sounding of the buzzer, if fitted, and initiates the following actions:

compressor: works in Duty Setting; the "ON" times are, however, determined by the parameter "A6" and not by the parameter "c4", as in the case of a regulation error.

fan: continues to work according to fan parameters (F). If the external alarm is registered during defrost or a continuous cycle, control exits from the procedure.

When the **alarm ceases** the unit resumes normal temperature control operation.

WARNING: If $A8 = 1$ the alarm can be activated by a specific command from the supervisory system (if the latter exploits the functions supplied by the MPXs) or, on Slave units where $A8 = 1$, by the opening of the digital input DIN2 on the Master.

Important note: it should be remembered that to guarantee the safety of the unit in the case of serious alarms, the unit itself must always be fitted with all the electro-mechanical safety devices needed to ensure correct operation.

A4/A5/A8 = 2: input associated to delayed external alarm

The significance, connection and operating mode are similar to those already indicated for the parameter $A4=1$. However, when $A4=2$ it is possible to delay the alarm signal for a period in minutes equivalent to value chosen for $A7$. After the set delay period, the effects on the compressor, fans, defrost and continuous cycle are the same as when $A4/A5/A8=1$.

A4/A5/A8 = 3: input associated to defrost activation

An external contact can be connected to the multi-function input to prepare for or to inhibit defrost. When the contact is open, defrost is inhibited, and when closed, defrost is possible. If the contact is closed, yet no defrost is requested, the defrost is obviously not performed. If the contact is closed and a defrost is in progress, the opening of the digital input will end the current defrost, while successive defrosts will be inhibited, until the next closing of the same digital contact. This function is useful, for example, with refrigerated cabinets fitted with hot gas defrost. With these installations it is necessary to defrost an "island" at a time, so at any one moment, some islands will be enabled for defrost and others inhibited. Another use for this function is to inhibit defrost of those units open to the public during shopping hours.

ATTENTION: If $A8 = 3$ the defrost of a unit can be enabled/disabled by a command from the supervisory system (if the latter exploits the functions supplied by the MPXs) or by the closing/opening of digital input DIN2 on the Master (if $A9 = 1$ on the Master). In this way, using only the DIN2 digital contact on the Master, the defrost of an entire multiplexed sub-network (Master + connected Slaves) can be enabled/disabled, or only of those units in the sub-network where $A8 = 3$.

NOTE: the enabling/disabling of defrost by digital contact is local for all units; a Master, with $A4/A5/A8 = 3$ and with its corresponding digital input open, cannot defrost locally, while it may command the defrosts of its connected Slaves (manual, cyclical or timed defrost: the latter option is only available on models fitted with RTC)

A4/A5/A8 = 4: input associated to defrost by contact

This function allows the defrost to be activated by an external contact. If the defrost is activated by an external contact, all the type "d" parameters selected remain valid. In particular, it may be useful to set $dI=0$ and inhibit defrosts by RTC (on Master units fitted with RTC) if manual defrosts, or by external contact only are desired. This function is useful for performing **real time defrosts**. To do this, simply connect a mechanical or electronic timer to the digital input. When the contact of the timer switches from open to closed, the request for defrost is activated. As mentioned in the description of parameter $d5$, more than one unit can be connected to the same timer. By selecting a different value of $d5$ for each unit, simultaneous defrosts can be avoided.

NOTE: in the case of a Master with connected Slaves, on the closing of its digital contact a network defrost will be performed, even when a local defrost cannot be performed.

ATTENTION: If $A8 = 4$ on Master unit with connected Slaves, a network defrost can be performed by a command from the supervisory system (if the latter exploits the functions supplied by the Master).

If $A8 = 4$ on one Slave a defrost can be performed by:

- a command from the supervisory system (if the latter exploits the functions supplied by the Master that the Slave is connected to, and if the Master is fitted with built-in RS485 interface);
- the closing of the digital input DIN2 of the Master (if on the Master $A9 = 1$).

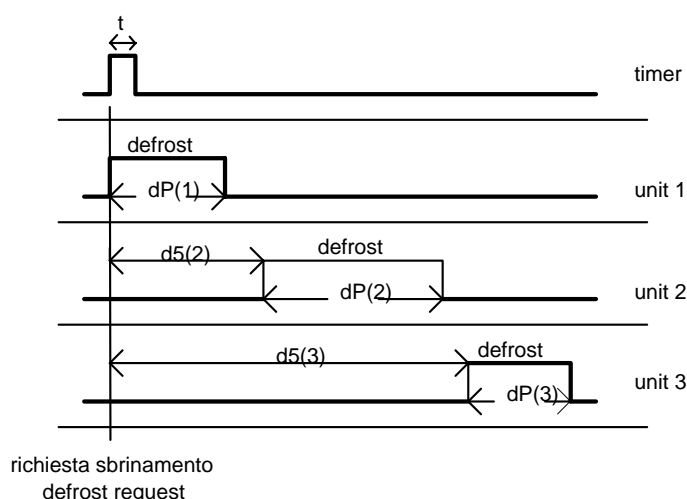

EXPLANATION:

t = impulse from timer to start defrost, the minimum duration must be 0.5 seconds

$dP(1)$ = maximum duration of defrost, unit 1

$d5(2)$ = external contact's defrost delay for unit 2. This must be greater than $dP(1)$ if two units are not to be defrosted at the same time

Similarly for $d5(3)$ and $dP(3)$

A4/A5/A8 = 5: Door Switch

Setting A4/A5/A8= 5 controls the switch on the store-room door. When the switch is opened the compressor and the fans are switched off and the lights are switched on (if at least one of the two fan or AUX relays is configured as an auxiliary and is used as a light relay). When the door is closed (as well as the Multifunction contact), the unit resumes the previous operation, delaying any temperature alarm by a number of hours equivalent to the value of d8. If the door stays open for a time longer than d8, the display begins to flash and the controller returns to normal operation, the same as before the door was opened. Specifically:

- if the controller was in Duty Setting it returns to Duty Setting mode;
- if the controller was in continuous cycle it returns to continuous cycle and the maximum time for the continuous cycle is extended by the length of time the door was opened;
- if the controller was in defrost it remains in defrost;

On re-starting the compressor, however, any protective time constraints selected will be respected (see 'c' parameters).

Note: even if the fan is controlled by the fan controller (see category F), the fans will be shut down.

ATTENTION: the "Door Switch" algorithm can be activated on units where A8 = 5 by a command from the supervisory system (if the latter exploits the functions supplied by the Master) or by the opening of the second digital input (DIN2) on the Master (if on the Master A9=1)

A4/A5/A8 = 6: control off by digital contact

Contact closed = **On** ; contact open = **Off**

In "Off" status the controller displays the temperature alternating with the symbol "_ _". It only displays the temperature, and does not control the compressor or the fans, which are off, nor monitors for any alarms. In the case where the temperature displayed is outside the limits of the instrument, the code "or" is displayed (out-of-range). The instrument ignores requests for defrost, continuous cycle and Duty Setting. If the instrument in Off status is a Master with a sub-network of Slaves, this may still manage a network defrost (even using another digital contact) and signal any alarms on remote units.

ATTENTION: machines where A8 = 6 can be placed in **Off** status by a command from the supervisory system (if the latter exploits the functions supplied by the Master) or by the opening of the second digital input (DIN2) on the Master (if on the Master A9=1 and if the machine is a Slave)

A4/A5/A8 = 7: automatic variation of the set-point by digital contact

Contact closed, night-time set-point; contact open, daytime set-point (set-point set by user interface using the SEL button).

For the night-time set-point; the value of the set-point is added to the value (with sign) of parameter "r4". Thus the new set-point is:

Daytime set-point + "r4"

The switching-on of the lights is associated to the opening of the digital contact if the auxiliary relay is used as a light switch.

ATTENTION:

The daytime/night-time set-point can be modified by a command from the supervisory system and/or by the opening/closing of the second digital input on the Master (DIN2) (if A9 = 1 on the Master unit), on all units where A8 = 7.

Practical example:

in a multiplexed sub-network, setting A8 = 7 on all units, simply connect the second digital input of the Master to a switch to be able to manage the light relay and the variation of the set-point for all the controllers.

Summary of the programmable digital inputs: list of options

Value A4/A5/A8	Meaning	Function
0	input not active	
1	immediate external alarm	Contact open =alarm active
2	external alarm with delay	Contact open =alarm active. Delay: see parameter A7
3	enable defrost	Contact open =defrost not enabled
4	start defrost	Defrost is activated when the contact closes. It can be used for real time defrost. Simply connect the digital input to a clock with power back-up, select A4=4 (if the chosen input is DIN1) or A5=4 (if the chosen input is DIN2). To exclude cyclical defrost automatically activated by the controller, set dI=0.
5	door switch	Contact open =door open. When the door is open the compressor and the fan are turned off. If H1=0, or H1 = 3, or F4 = 1, or F4 = 2, the auxiliary relay is activated to turn the light on. If the door stays open for a time longer than d8, the display will begin to flash and the controller will restart normal operation (compressor and fan ON, if required).
6	remote On/Off	Contact closed= On. Contact open = Off
7	curtain switch	Contact closed = curtain down. If the input is selected as curtain switch, when the contact closes the controller modifies the set point adding the value of parameter r4. With r4=3.0 (pre-programmed value), the set is increased by 3 degrees from the value used for the open curtain. If the auxiliary output is used for the light switch (only for H1 = 0, or H1 = 3, or F4 = 1, or F4 = 2) the lowering of the curtain automatically switches off the light, while the raising of the curtain switches it on.

A9: Enable the propagation via the LAN of the Master's second digital input

This parameter is accessible only for instruments configured as Master. It allows "parallel connection" to the virtual digital input on the connected Slave units of the Master's second (physical) digital input DIN2. In this way, the second digital input of the Master may be propagated or not to the Slaves.

1 = DIN2 can be propagated;

0 = DIN2 can not be propagated;

For Stand-Alone Master units, set the value of A9 to 0.

Def.: A9=1; Available on all models, if configured as Master

Some important warnings:

For correct management of the functions associated to the digital inputs, the values of A4, A5, A8 must be different from one another, or else null. That is, when A4, A5, A8 have values other than zero, the following must be true: $A4 \neq A5$, $A4 \neq A8$, $A5 \neq A8$. By default A4, A5, A8 are zero and, thus the corresponding inputs are not associated to any special functions.

Note: The configuration of a controller's digital inputs is carried out only during installation. It is good practice, after having configured the controller's digital inputs, to carry out a manual reset (pressing the PRG SEL and UP buttons for 5 seconds) of the controller. In the case of a multiplexed network, slaved, using the virtual digital input of the Master, to a supervisory system that controls, for example, the synchronisation of the defrosts, the day/night set-point etc., the propagation of the second digital input of the Master must be disabled, setting $A9 = 0$ from the supervisory system, before using the command interface that the Master offers the Supervisor. This operation ensures the correct response of the multiplexed network to the commands from the supervisory system and the synchronisation of the controllers to the same commands. Failure to heed this warning may lead to anomalies in the operation of the controllers, both in stand-alone systems (i) and (ii) and in network systems (iii) !!!

A6: Compressor stop by external alarm

The function of this parameter is similar to that of parameter c4 (duty setting). As well as acting on the probe alarm, it acts on the external alarm via the multi-function input ($A4/A5/A8=1$ or 2). When an external alarm occurs (whether immediate or delayed), the compressor works for a period equivalent to the value given to parameter A6 (in minutes), while remaining off for a fixed period of 15 minutes.

When given two particular values, A6 serves the following functions:

A6=0: the compressor always remains off;

A6=100: the compressor always remains on.

The fans continue to be controlled according to the selected parameters (see category F).

- *Parameter can be transferred via LAN from the Master to its connected Slaves.*

- *Available on all models*

- *Def.: A6=0 (compressor off in the case of external alarm)*

A7: Delay in signalling of external alarm (multi-function input)

Sets the delay (in minutes) in signalling the external alarm when $A4/A5/A8=2$.

- *Parameter can be transferred via LAN from the Master to its connected Slaves.*

- *Available on all models*

- *Def.: A7=0*

Ar: Enable Master for the signalling of alarms on remote Slave units.

The Master unit, if $Ar = 1$, can indicate the presence in its own sub-network of a Slave in alarm. If an alarm is activated on one Slave, the Master displays the signal "nX", alternating with the display of the temperature, where X is the address of the Slave in alarm ($X = 1, \dots, 5$). If on the Master relay 4 is configured as an alarm relay ($H1 = 1$, or $H1 = 2$), the alarm relay of the Master is also activated.

- *Available on all models, if configured as Master*

- *Def.: 1; Monitoring enabled*

11.10 F = parameters for controlling the evaporator fans

F	FAN PARAMETERS	Type	Min	Max.	UOM	Def.	To LAN	New
F0	Fan management: 0 = fan always ON (except in special cases: see parameters F2, F3, Fd) 1 = fans thermostat-controlled in accordance with the absolute set-point F1	C	0	1	flag	0	•	
F1	Fan start absolute set-point - <i>Active if F0 = 1</i>	F	-40	+50	°C/°F	5.0	•	
F2	Fans OFF with compressor OFF (0 = No, 1 = Yes) - <i>Active if F0 = 0</i>	C	0	1	flag	1	•	
F3	Fans OFF in defrost (0 = No, 1 = Yes) - <i>Active if F0 = 0</i>	C	0	1	flag	1	•	
F4	FAN relay configuration as AUX relay (in this situation the fourth relay can be used as an alarm relay by setting H1 = 1 or H1 = 2): 0 = the aux relay is the fourth relay 1 = the aux relay is the fan relay (local relay) 2 = the aux relay is the fan relay (network relay)	C	0	2	flag	0	•	
Fd	Fan off in post-dripping	F	0	15	min.	1	•	

The “F” parameters are available on the following models:

IRMPX10000, IRMPX1M000, IRMPX1A000, IRMPXM0000, IRMPXMM000, IRMPXMA000

F0: Fans managed by fan controller

The fans can be put under the control of the fan controller, which manages them according to the temperature measured by the defrost and control probes. Alternatively, the fans can work constantly, with the possibility of switching them off when the compressor is off (see parameter F2), during defrost (see parameter F3), during a dripping period (see parameter dd) and for a further post-dripping period (see parameter F1). Values allowed for this parameter are:

F0 = 0 : in this case the fans are not subject to fan control, but to parameters F2, F3 and Fd.

F0 = 1 : the fans are subject to fan control (see parameter F1)

It should be remembered that if a dripping period has been provided for (dd not=0), the fans will be stopped in any case.

- Parameter can be transferred via LAN from the Master to its connected Slaves.

- Def.: F0=0, that is, not subject to fan control.

F1: (Absolute Set Point) Fan stop temperature (operative only when F0=1)

The fans are activated when the temperature on the evaporator is less than (F1 - A0).

The fans are turned off if the temperature on the evaporator is above the absolute set-point F1.

- Parameter can be transferred via LAN from the Master to its connected Slaves. - Def.: F1=5

F2: STOP fans when compressor idle (parameter operative only when F0=0).

Selects whether the fans should operate continuously (except F3, dd and Fd) or only when the compressor is working. If F0=1 the fans are managed by the fan control and therefore are working or off according to the difference between evaporator and ambient temperatures, irrespective of the state of the compressor.

F2=0 (=no): Fans operate even if compressor is off.

F2=1 (=yes): Fans are off when the compressor is off.

- Parameter can be transferred via LAN from the Master to its connected Slaves. - Def.: F2=1, fans off when compressor off

F3: Stop fans during defrost (parameter operative only when F0=0)

Selects whether the fans should operate during defrost. Inactive if the fans are managed by the fan control.

F3=0 (no): fans work during defrost;

F3=1 (yes): fans do not work during defrost.

Please remember that during the dripping waiting time (in the case of network defrost, if featured), the fans are always off.

- Parameter can be transferred via LAN from the Master to its connected Slaves. - Def.: F3=1, evaporator fans off during defrost.

F4: configuration of the fan relay as an auxiliary relay

This parameter allows the fan relay to be configured as an auxiliary (local or network) allowing the fourth relay to be used as an alarm relay (H1 = 1 or H1 = 2). If F4 = 1 or F4 = 2, the interventions normally performed on the 4th relay are re-routed to the fan relay, which acts as an auxiliary relay. If F4 = 1 the fan relay can only be managed locally; if F4 = 2 the fan relay may be commanded via LAN, for example, by pressing the AUX button on a Master unit.

- Parameter can be transferred via LAN from the Master to its connected Slaves. - Def.: F4= 0.

Fd: fans off during post-dripping

The fans, after the defrost, can be stopped for a further period (in minutes) defined by the value of Fd. This is useful in allowing the evaporator to return to the correct temperature after the defrost, thus avoiding forcing “hot” air into the refrigeration unit. In the case of fan controller management, Fd does not need to be selected, in that the fan controller starts the fans only when the evaporator has reached the correct temperature. If fan control is active (F0=1), on assigning Fd a value other than zero, the fans **stay off** for a period equal to the value of Fd, irrespective of the temperature of the evaporator.

- Parameter can be transferred via LAN from the Master to its connected Slaves. - Def.: Fd= 1.

NOTE: Please remember that during the dripping time (dd) and post-dripping time (Fd), if set to a value other than zero, the fans will in any case stay off, irrespective of the values assigned to parameters F0, F2 and F3.

11.11 H = other settings

/H	OTHER PRE-SETTINGS	Type	Min	Max.	UOM	Def.	To LAN	New
H0	Serial address (only for the network Master)	C	0	199	-	0		
H1	Relay 4 selection: 0 = auxiliary output 1 = alarm relay, normally open (closed in alarm) 2 = alarm relay, normally closed (open in alarm) 3 = auxiliary relay: Master serves the Slaves; the action of the Master relay is transmitted via LAN to the Slaves, the 4 th relay of which is configured with H1 = 3	C	0	3	flag	3		
H2*	-	-	-	-	-	-	-	
H3*	-	-	-	-	-	-	-	

(*) not managed

H0: Serial address

Sets an address for the unit for connection to a supervisory or telemaintenance system. Also used for serial or network connection.

- Available only on models: IRMPX0M000, IRMPX1M000, IRMPXMM000

- Def.: H0 = 0

H1: Configuration of the fourth relay:

This parameter allows the fourth relay to be configured as a local or network auxiliary relay, or as an alarm relay; in this case the parameter H1 also allows the selection of “rest” as the position of the alarm relay.

0 = auxiliary output

1 = alarm relay normally closed

2 = alarm relay normally open

3 = auxiliary relay: served by the master to the slaves; on the master the action of the relay is propagated via the LAN to the slaves, where the 4th relay is configured using H1=3

- Available on models: IRMPX10000, IRMPX1M000, IRMPX1A000, IRMPXM0000, IRMPXMM000, IRMPXMA000

- Def.: H1 = 3 : the relay is configured as a network auxiliary

H2: Enable remote control

Enables or disables the use of the remote control for the instruments that feature this function.

H2 = 0, remote control enabled;

H2 = 1, remote control disabled.

- Available on models: IRMPX0A000, IRMPX1A000, IrmpxMA000, IRMPXMAC00

- Def.: H2=1

H3: Instrument identification code for programming by remote control

This parameter sets the code that enables the controller to receive the commands from the remote control. If there are a series of instruments enabled for the use of the remote control, when pressing the “start” button on the remote control, all the instruments will “respond”, waiting for the code from the remote control; this code thus allows the operator to identify and thus select which instrument to operate on.

- Available on models: IRMPX0A000, IRMPX1A000, IrmpxMA000, IRMPXMAC00

- Def.: H3=0

LAN PARAMETERS		Type	Min	Max.	UOM	Def.	To LAN	New
Sn	Number of Slaves: parameter accessible only on the Master units (0 = LAN not present)	C	0	5	-	0		
SA	Slave address in the LAN parameter accessible only on the Slave units (0= LAN not present)	C	0	5	-	0		
In	Configuration parameter of the single unit as Master (In = 1) or Slave (In = 0)	IN	0	1				

Sn: Number of Slaves

This parameter informs the Master of the number of Slaves it must manage. It can be accessed using a password (22) and is used during the installation of a network of Master and Slaves

- Available on all models, if configured as Master

- Def.: Sn = 0 : Master stand-alone

SA: Slave Address

This parameter is assigned to the Slave when it is installed in a multiplexed network managed by a Master. It is the address of the unit in the network: the correct assigning of this number means the Master may communicate correctly with this unit.

- Available on all models, if configured as Slave

- Def.: SA = 0 : Slave stand-alone

Procedure for the installation of a multiplexed network:

- 1) Assign the value of Sn on the Master
- 2) Assign the value of SA on each Slave

Please heed the following warnings:

- During installation, check that in the multiplexed network the values of SA on the various units are different from one another.
- The value that may be assigned to SA must not be above the value of Sn on the Master, if the unit is to be correctly managed by the latter.
- In a multiplexed network, only one unit can be configured as Master

In: Installation parameter

The value of this parameter configures the unit as Master or Slave; this can be accessed by pressing the PRG and SEL buttons together for 5 seconds during the power on phase of the instrument, that is, when first 3 hyphens and then the identification code of the unit as Master (uM) or slave u? (? = 1 ... 5: address of slave in the LAN) are displayed.

- In = 1: unit configured as Master
- In = 0: unit configured as Slave

- Available on all models

- The default for this parameter depends on the model of the instrument; see the second row of the following table for the default values of the various models:

IRMPX00000	IRMPX0M000	IRMPX0A000	IRMPX10000	IRMPX1M000	IRMPX1A000	IRMPXM0000	IRMPXMM000	IRMPXMA000	IRMPXMB000
0	1	0	0	1	0	1	1	1	1

NOTE: in all models configured as Slave access is denied (even by password) to the following parameters: “H0”, “Sn”, “Ar”, “A9”, the clock and the parameters for setting the defrost times; **units configured as Slaves do not manage these !!!**

	RTC PARAMETERS (only on Master unit)	Type	Min	Max.	UOM	Def.	To LAN	New
hh	Current hour	F	0	23	hours	-		
mm	Current minute	F	0	59	min	-		
h1	Hour of the first defrost	C	0	23	hours	24		
m1	Minute (of hour h1 on the current day) when a defrost starts	C	0	50	10 min	0		
h2	Hour of the second defrost	C	0	23	hours	24		
m2	Minute (of hour h2 on the current day) when a defrost starts	C	0	50	10 min	0		
----	-----	-----	-----	-----	-----	----		
----	-----	-----	-----	-----	-----	----		
h8	Hour of the eighth defrost	C	0	23	hours	24		
m8	Minute (of hour h8 on the current day) when a defrost starts	C	0	50	10 min	0		

The RTC parameters are present on models:

IRMPXM0000, IRMPXMM000, IRMPXMA000, IRMPXMB000

hh, mm: current hour and minute

These can be set as for the "F"-type parameters. Setting the current hour and minute automatically cancels the signalling of an RTC error: “tC”.

hX, mX: are respectively the hour and the minute set for the X-th defrost

If a defrost is required, for example, at 3:30 in the morning, set hX = 3 and mX = 30.

X = 1, 2, ... 8.

To inhibit defrost set hX = 24

The parameter mX can only be modified in steps of 10 min

12. Operating states of the units

As indicated above, the display LEDs can be in three states:

- **off**, when the function indicated or the actuator is not operative;
- **on**, when the function indicated or the actuator is operative;
- **flashing**, when the function is held up by an alarm situation, by a delay, or by a particular status of the Multifunction input.

There are however various specific operating states not directly indicated by the displays. This can lead to erroneous interpretation of the unit's operating state. For convenience, the status of the display in such situations is shown below:

SPECIFIC STATE	COMP LED	FAN LED	DEF LED	C. CYCLE LED
Between defrosts	◆	◆	off	◆
Awaiting defrost	◆	◆	off	◆
Defrost requested	◆	◆	flashing (1)	◆
Defrost in progress	◆	◆	on	◆
Dripping	off	off	off	◆
Post-dripping	◆	flashing	◆	◆
Serious alarm	◆	◆	◆	◆

(1) Only if the defrost requested is inhibited by digital contact and if the request for defrost comes from the digital input; the defrost is performed as soon as the enabling digital contact is closed.

◆ signifies that the LED may be on, off or flashing depending on the other parameters and ambient factors (temperature, operating set, differential etc.). The general remarks made above on the status of the LEDs should be kept in mind.

12.1 Sequence of the main phases

For easy reference, below is a diagram showing the sequence of all the possible phases in the defrost process. It should be remembered that some phases (e.g. dripping or post-dripping) can be activated or inhibited by an appropriate choice of parameters. The type of activators being controlled and the type of control depend on the type and configuration of the units selected.

PHASE	normal operation	defrost	await dripping	dripping	post dripping	resumption normal op.
ACTIVITY	unit's temperature controlled	evaporator defrosted as required	the defrost relay is off, while the controller awaits the other units to end defrost	compressor and evaporator fans are off in order to help drainage of water after defrost	fans are off to allow the evaporator to reach operating temperature	temperature control resumed

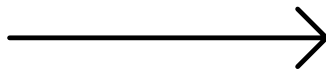

The sequence progresses from left to right.

13. Alarms

13.1 Defective or incorrect operation

The units in the MPX range are able to signal most incorrect operations automatically. When a malfunction occurs, the microprocessor initiates the following actions:

- the malfunction is signalled on the display by an appropriate alarm code. More specifically, the display shows the alarm code and the temperature read by the probe, alternating in sequence.
- if more than one alarm occurs at the same time, these are signalled in sequence, alternating with the temperature.
- for some alarms an internal buzzer, if fitted, emits an audible warning.
- for these alarms, the AUX relay, where fitted and if configured as an alarm output, will be activated.



Pressing the  button silences the buzzer and de-energises the relay for 10 min, while the alarm code only disappears when the corresponding cause is eliminated. The alarm codes are listed in the table below:

ALARM CODE	BUZZER and AUX Relay	CAUSE	MODELS applicable
rE	active	regulation probe error	ALL
E0	inactive	ambient probe error (S1)	ALL
E1	inactive	defrost probe error (S2)	ALL
E2	inactive	product probe error (S3)	ALL
IA	active	immediate external alarm	ALL, if external alarm connected
dA	active	delayed external alarm	ALL, if external alarm connected
L0	active	low temperature alarm	ALL
HI	active	high temperature alarm	ALL
EA, Eb	inactive	data saving error	ALL
Ed	inactive	defrost end by time-out	ALL
dF	inactive	defrost in progress	ALL
tC	inactive	RTC invalid	Masters with RTC
MA	active	Lost contact with the Master	Slave units
u'x' (x= 1,...,5)	active	Slave 'x' not communicating	Master units
n'x' (x= 1,...,5)	active	Slave 'x' in alarm	Master units
d'x' (x= 1,...,5)	inactive	Download failed on Slave 'x'	Master units

13.2 Description of the signals flashing on the display of the MPX

rE FLASHING

Regulation probe error:

- Probe malfunction: the probe signal is interrupted or short-circuited;
- Probes not compatible with the instrument.

E0 or E1 or E2 FLASHING

Probe error (S1, S2 or S3 respectively)

- Probe not working because the signal is interrupted or there is a short circuit
- Probe not compatible with the unit

IA FLASHING

Immediate multi-function digital input alarm

- Check the multi-function input and parameters A4 and A5.

Ad FLASHING

Delayed multi-function digital input alarm

- Check the multi-function input and parameters A4, A5 and A7.

L0 FLASHING

Low temperature alarm. The probe has measured a temperature further below the set value than the value set for parameter AL.

- Check parameters AL, Ad and A0.

The alarm will cease as soon as the temperature returns within the set limits (see parameter AL).

HI FLASHING

High temperature alarm. The probe has measured a temperature further above the set value than the value set for parameter AH.

- Check parameters AH, Ad and A0.
- The alarm will cease as soon as the temperature returns within the set limits (see parameter AH).

EA, EB DISPLAYED DURING OPERATION OR WHEN SWITCHING-ON

Data acquisition error.

- See the section on “Procedure for re-configuring the controller with the default parameters”.

Ed FLASHING

The last defrost has stopped due to the expiry of the maximum time, rather than the end defrost set temperature being reached.

- Check parameters dt, dP and d4.
- Check the effectiveness of the defrost.
- If the next defrost ends due to temperature the signal will automatically disappear.

dF FLASHING

Defrost in progress.

- This is not an alarm signal but rather an indication that the unit is carrying out a defrost.
- Appears only if parameter d6=0 or d6 = 2.

“TC” FLASHING

RTC error on the units fitted with RTC and configured as Master:

- Set the hour and minutes on the user interface

“n1,... n5” FLASHING ON THE MASTER

Slave 1, ..., 5 in local alarm:

- Press AUX to reset the alarm

“u1, ... u5” FLASHING ON MASTER

Loss of communication with Slave 1, ..., 5 for around 3 minutes:

- Check LAN electrical connections

“MA” FLASHING ON SLAVE

Loss of communication between the Slave and the Master for at least 1 minute.

The defrost will be performed in any case by the timer, which was reset to the value of parameter “dI” after the previous defrost.

- Check the electrical connections between the Slave and the LAN;
- The resetting of the network signals (both on the Master and the Slaves) occurs automatically as soon as communication is restored between the Master and the Slave;

“d1, ..., d5” FLASHING ON THE MASTER



Failed parameter download on unit 1, ..., 5

- Check the wiring of the LAN

- Press  for 5s to reset this signal.

NOTE: The alarms on the Slave that generate the alarm n”x” (x= 1,...,5) on the Master are:
HI, LO, dA, IA, and rE.

14. Troubleshooting

PROBLEM	CAUSE	CHECK
compressor does not start : <ul style="list-style-type: none"> power on compressor LED flashing 	compressor delay in progress	parameters c0, c1 and c2
temperature is outside set limits but no alarm signalled and the buzzer, if fitted, does not sound	alarm delay in progress	check Ad
the AL or Ad alarm signalled (Multi-function input) without in fact being active	Multi-function input generates alarm as power goes on	check connection of input and whether it is off in normal operation
the alarm connected to Multi-function input is not signalled	alarm delay operating or parameter programming error	see whether A4/A5=1 or A4/A5=2; if A4/A5=1 check status of digital input; if A4/A5=2 check A7
defrost not activated : <ul style="list-style-type: none"> contact open defrost LED off 	<ul style="list-style-type: none"> defrost cycle too short (dP) interval between defrosts dI=0: in this case the defrost is not activated no defrost time set 	parameter dP and dI
manual defrost not activated and defrost LED flashing	compressor protection delays in progress	parameter d9 (select d9=1)
high temperature alarm given after defrost	alarm delay after defrost too short or alarm threshold too low	parameter d8 and AH and Ad
<ul style="list-style-type: none"> fans do not start fan power on compressor LED flashing fan LED flashing 	<ul style="list-style-type: none"> compressor and fan delay selected if F0=1 (fans under fan control) evaporator is warm: temperature can be read by selecting parameter /d dripping is in progress a post dripping delay is in progress if F0=0 F2=1 and compressor off dripping is in progress post-dripping shut-down 	<p>check c0 parameters F0, F1, Fd, dd</p> <p>parameters F0, F2, dd and Fd</p>
after changing a value, or programming, the controller continues to work with old values	unit has not yet updated the new values, the parameters have not been satisfactorily saved, by pressing 	switch off the controller or program parameters again correctly
continuous cycle is not activated	press  before  .	

15. Technical specifications

15.1 Technical characteristics:

Probe type:	NTC Carel
Operating field:	-55°c - +95°c
Precision :	± 0.5°C
Storage:	-10°C/ 70°c
Operating conditions:	0°C/+50°c
Power supply:	12Vac
Power consumption:	150mA
Front panel index of protection:	IP65 with panel mounted and gasket inserted
Fastening:	by bracket
Connections:	Molex-type crimped connectors
Classification according to protection against shock:	should be integrated in class I or II devices
Number of automatic cycles for each automatic action:	100,000
Disconnection action type:	1B
PTI of materials used for insulation:	250V
Environmental pollution:	normal
Heat and fire resistance category:	D
Software class and structure:	class A
Safety device:	watch dog
Display:	2 and a half digits
Light signals:	compressor, continuous cycle, defrost, fan alarm/auxiliary output
Audible signal:	buzzer (optional)
Inputs:	regulation probe, defrost probe, cabinet hot-point probe, two
multifunction digital inputs	
Relay outputs (all):	type of action of the device 1C - nominal values of the 3a/250Vac relays
Compressor:	SPST relay, I _{max} = 3A res (2A), Vac max=250V
Defrost:	SPDT relay, I _{max} = 3A res (2A), Vac max = 250V
Fan	SPST relay, I _{max} = 3A res (2A), Vac max = 250V
Aux/alarm output:	SPST relay, I _{max} = 3 res (2A), Vac max = 250V
RTC rechargeable backup battery:	duration of charged battery at least 72 hours
Immunity to disturbance - electromagnetic compatibility conforming to standards:	The devices pass the EMC tests for general and domestic environments (En50082- 2 (immunity)
En50081- 2 (emission)	
Conformity to safety standards for devices in l.v.:	En60730-1
Disposal of the product:	do not dispose of the device as ordinary waste. To dispose of the device refer to the environmental protection laws in force in your country

(*) only on models with this function available

Note: the cables to be connected to the controller must be heat resistant (90°C)

15.2 Temperature/Resistance ratios for NTC thermistors

The temperature probes with NTC thermistors, normally featured on the MPX controllers, change resistance as the temperature changes. Following is a description of the resistance values corresponding to various temperatures. In the case of malfunction or inaccurate control, users can check the operation of the probes as follows:

- with a standard thermometer to determine the temperature measured by the probe
- with an ohmmeter measure the resistance at the head of the probe and compare it with the values in the table.

In view of the variation shown by thermistors, three resistance values are given in the table for each temperature.:

- Rstd = the typical resistance value at the temperature indicated;
- Rmin is the minimum value;
- Rmax is the maximum value.

For the sake of simplicity, the values corresponding to only a limited number of temperatures are given. Intermediate values can be determined by interpolation.

Temperature/Resistance ratios for the Carel NTC temperature probe
--

Temperature	Rmin	Rstd	Rmax
-40 °C	181.10 kΩ	188.40 kΩ	195.90 kΩ
-30 °C	107.50 kΩ	111.30 kΩ	115.10 kΩ
-20 °C	65.80 kΩ	67.74 kΩ	69.74 kΩ
-10 °C	41.43 kΩ	42.25 kΩ	43.50 kΩ
0 °C	26.74 kΩ	27.28 kΩ	27.83 kΩ
10 °C	17.67 kΩ	17.95 kΩ	18.24 kΩ
20 °C	11.95 kΩ	12.09 kΩ	12.23 kΩ
30 °C	8.21 kΩ	8.31 kΩ	8.41 kΩ
40 °C	5.73 kΩ	5.82 kΩ	5.92 kΩ
50 °C	4.08 kΩ	4.16 kΩ	4.24 kΩ
60 °C	2.95 kΩ	3.02 kΩ	3.09 kΩ
70 °C	2.17 kΩ	2.22 kΩ	2.28 kΩ
80 °C	1.62 kΩ	1.66 kΩ	1.71 kΩ
90 °C	1.22 kΩ	1.26 kΩ	1.30 kΩ

15.3 View of the instrument

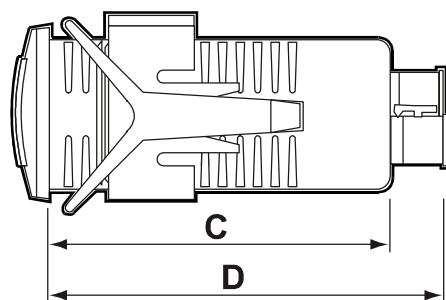
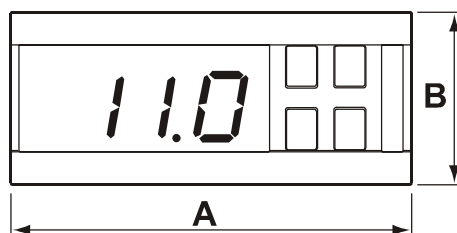

Dimensions of the MPX in mm:

A	=	75
B	=	34
C	=	66
D	=	75

16. WIRING DIAGRAMS

Master/Slave connection wiring diagram:

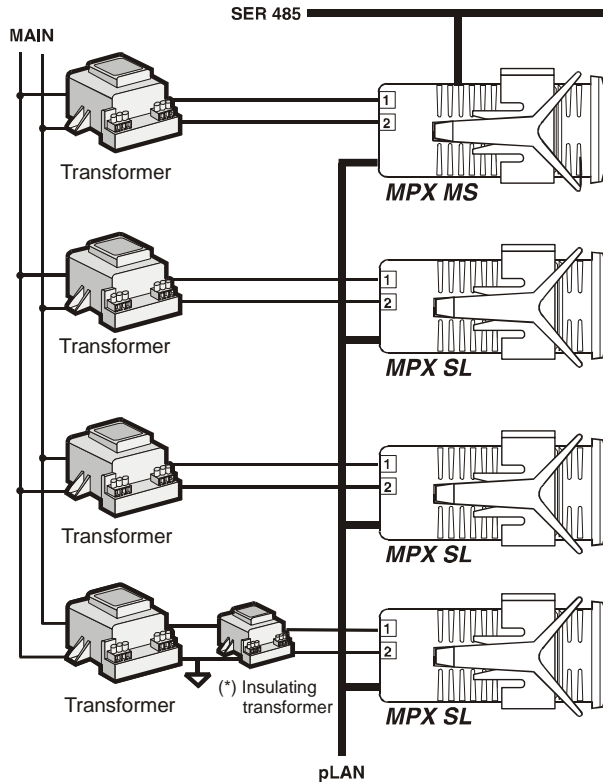

Example of wiring for serial connection of the instruments:

Main = mains power supply

TRF = transformer

INS TRF = insulating transformer

⏚ = earth

SER = multiple connection to the controller system

16.1 MPX contact rear view:

Label of connections for the **IRMPX10000** model (slave with 4 relays):

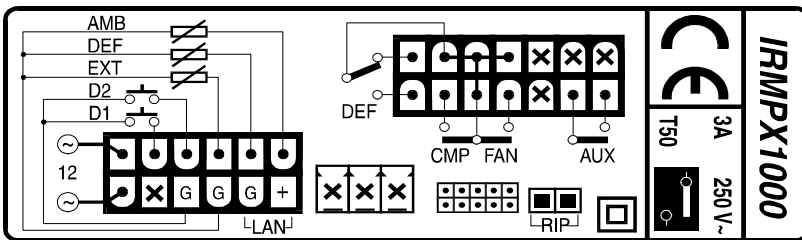

Label of connections for the **IRMPXM0000** model (Master with 485):

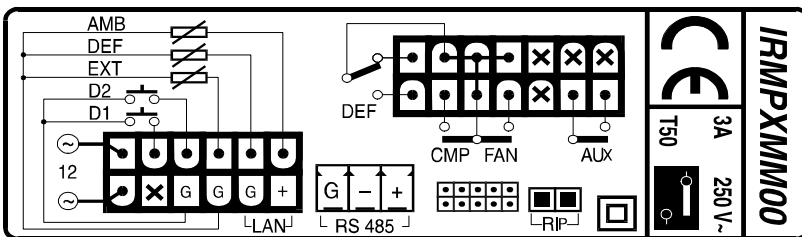

17. Summary of parameters

PARAMETER	Type	Min.	Max.	UOM	Def.	To LAN ²	New	
PA	PASSWORD PARAMETERS							
	LOG PASSWORD	C	00	199	-	22		
	DOWNLOAD PASSWORD	C	00	199	-	66		
/	PROBE PARAMETERS							
St	Temperature set-point		r1	r2	°C/°F	-10.0	•	
/C	Regulation probe calibration	F	-20	+20	°C/°F	0.0		
/2	Measurement stability	C	1	15	-	1		
/3	Probe reading rate	C	1	15	-	1		
/4	Virtual probe (between probe 1 and probe 3) (0 = probe 1; 100 = probe 3)	C	0	100	-	0	•	
/5	°C/°F (0 = °C; 1 = °F)	C	0	1	flag	0	•	
/6	Decimal point enabling (0 = No, 1 = Yes)	C	0	1	flag	0	•	
/7	Display on main display and repeater 0 = repeater not present 1 = 3rd probe reading only on repeater 2 = 3rd probe reading also on main display 3 = virtual probe reading on the main display and defrost probe on repeater	C	0	3	flag	0	•	
/8	3rd probe calibration	C	-20	+20	°C/°F	0.0		
/9	Defrost with probe 3 1 = the defrost in temperature ends when the temperature measured by probe 3 is >= the temperature set for parameter "dt"	C	0	1	flag	0	•	
/d	Defrost probe calibration	C	-20	+20	°C/°F	0.0		
/A	Defrost probe present 0 = defrost probe and third probe absent 1 = defrost probe absent and probe 3 present 2 = defrost probe present and probe 3 absent 3 = both defrost probe and probe 3 present	C	0	3	flag	3	•	
r	REGULATION PARAMETERS							
rd	Regulator differential (hysteresis)	F	0.1	+20	°C/°F	2.0	•	
r1	Minimum set allowed to the user	C	-50	r2	°C/°F	-50	•	
r2	Maximum set allowed to the user	C	r1	+199	°C/°F	90	•	
r3	Ed alarm enabling (defrost interrupted for timeout) 0 = No, 1 = Yes	C	0	1	flag	0	•	
r4	Automatic variation of the night-time set-point (curtain switch closed)	C	-20	+20	°C/°F	3.0	•	
r5	Enable min. and max. temperature monitoring	C	0	5	flag	0	•	
r6	Night-time variation with third probe (1 = night with curtain lowered, regulation with probe 3; 0 = night regulation with the virtual probe)	C	0	1	flag	0	•	
rt	Min. and max. temperature measuring interval	F	0	199	hours	-		
rH	Max. temperature measured in the interval "rt"	F	-	-	°C/°F	-		
rL	Min temperature measured in the interval "rt"	F	-	-	°C/°F	-		

² **NOTE:** the "to-LAN" column in the table identifies the parameters that can or can not be transferred via LAN from the Master to the Slave.
Cod. +030220191 rel. 2.0 dated 25/06/01 (preliminary version)

c	COMPRESSOR PARAMETERS	Type	Min.	Max.	UOM	Def.	To LAN	New
c0	Compressor start delay when the instrument is turned ON	C	0	15	min.	0	•	
c1	Minimum time between two successive compressor starts	C	0	15	min.	0	•	
c2	Minimum compressor off time	C	0	15	min.	0	•	
c3	Minimum compressor on time	C	0	15	min.	0	•	
c4	Relay safety (0 = compressor always OFF, 100 = compressor always ON)	C	0	100	min.	0	•	
cc	Continuous cycle duration	C	0	15	hours	4	•	
c6	Low temp. alarm exclusion-time after continuous cycle	C	0	15	hours	2	•	

d	DEFROST PARAMETERS	Type	Min.	Max.	UOM	Def.	To LAN	New
d0	Defrost types 0 = electrical: ends by temperature and/or for timeout 1 = hot gas: ends by temperature and/or for timeout 2 = electrical: ends for timeout 3 = hot gas: ends for timeout	C	0	3	-	0	•	
dI	Interval between two defrosts (activated for defrosts without RTC)	F	0	199	hours	8	•	
dt	Defrost end temperature	F	-50	+199	°C/°F	4	•	
dP	Maximum defrost time	F	1	199	min.	30	•	
d4	Defrost when the instrument starts (0 = No, 1 = Yes)	C	0	1	flag	0	•	
d5	Defrost delay when instrument starts or from digital input	C	0	199	min.	0	•	
d6	Main display and repeater during defrost: 0 = No display block and the temperature alternates with the “dF” symbols on both displays 1 = display is blocked on both displays 2 = “dF” on both displays ³	C	0	2	flag	1	•	
dd	Dripping time after defrost	F	0	15	min.	2	•	
d8	High temperature exclusion time after defrost and if (A4 = 5, A5 = 5 or A8 = 5) alarm exclusion time from the opening of the door	F	0	15	hours	1	•	
d9	Defrost priority over compressor protection (0 = No, 1 = Yes)	C	0	1	flag	0	•	
d/	Defrost probe display (S2)	F	-	-	°C/°F	-		
dA	Third probe display (S3)	F	-	-	°C/°F	-		
dC	Time base for the intervals between defrosts and maximum duration (dP) (0 = hours/mins; 1 = mins/secs)	C	0	1	flag	0	•	

A	ALARM PARAMETERS	Type	Min.	Max.	UOM	Def.	To LAN	New
A0	Fan and alarm differential	C	0.1	+20	°C/°F	2.0	•	
AH	High temperature alarm: indicates the maximum variation from the set-point. AH = 0 excludes the high temperature alarm	F	0	+199	°C/°F	4	•	
AL	Low temperature alarm: indicates the maximum variation from the set-point. AL = 0 excludes the low temperature alarm	F	0	+199	°C/°F	4	•	
A4	Digital input no.1 configuration (*)	C	0	7	-	0		
A5	Digital input no.1 configuration (*)	C	0	7	-	0		
A6	Compressor stop (set Duty Setting from external alarm: A4 = 1 or 2; a5 = 1 or 2); 0 = compressor always OFF 100 = compressor always ON	C	0	100	min.	0	•	
A7	Detection delay time for the “delayed alarm” input (A4 = 2, or A5 = 2)	C	0	199	min.	0	•	
Ad	Temperature alarm delay	C	0	199	min.	120	•	
A8	Configuration of the instrument’s virtual digital input	C	0	7	-	0		
A9	Enable propagation via LAN of the second digital input on the Master (1 = propagation, 0 = no propagation)	C	0	1	flag	1		
Ar	Enable remote alarm signals from Slaves on the Master (1 = remote alarm signals enabled)	C	0	1	flag	1		

³ (*) Only the new repeaters with updated FW allow the display of the codes besides the temperature; the others, if d6 = 2, display only one fixed temperature.
Cod. +030220191 rel. 2.0 dated 25/06/01 (preliminary version)

F	FAN PARAMETERS	Type	Min.	Max.	UOM	Def.	To LAN	New
F0	Fan management: 0 = fan always ON (except in special cases: see parameters F2, F3, Fd) 1 = fans thermostat-controlled in accordance with the absolute set-point F1	C	0	1	flag	0	•	
F1	Fan start absolute set-point <i>Active if F0 = 1</i>	F	-40	+50	°C/°F	5.0	•	
F2	Fans OFF with compressor OFF (0 = No, 1 = Yes) <i>Active if F0 = 0</i>	C	0	1	flag	1	•	
F3	Fans OFF in defrost (0 = No, 1 = Yes) <i>Active if F0 = 0</i>	C	0	1	flag	1	•	
F4	FAN relay configuration as AUX relay (in this situation the fourth relay can be used as an alarm relay by setting H1 = 1 or H1 = 2): 0 = the aux. relay is the fourth relay 1 = the aux. relay is the fan relay (local relay) 2 = the aux. relay is the fan relay (network relay)	C	0	2	flag	0	•	
Fd	Fan off in post-dripping	F	0	15	min.	1	•	

H	OTHER SETTINGS	Type	Min	Max.	UOM	Def.	To LAN	New
H0	Serial address (only for the network Master)	C	0	199	-	0		
H1	Relay 4 selection: 0 = auxiliary output 1 = alarm relay, normally open (closed in alarm) 2 = alarm relay, normally closed (open in alarm) 3 = auxiliary relay: Master serves the Slaves; the action of the Master relay is transmitted via LAN to the Slaves, the 4 th relay of which is configured with H1 = 3	C	0	3	flag	3		
H2*	-	-	-	-	-	-	-	
H3*	-	-	-	-	-	-	-	

(* Available but not managed)

	LAN PARAMETERS	Type	Min.	Max.	UOM	Def.	To LAN	New
Sn	Number of Slaves: parameter accessible only on the Master units (0 = LAN not present)	C	0	5	-	0		
SA	Slave address in the LAN parameter accessible only on the Slave units (0 = LAN not present)	C	0	5	-	0		
In	Configuration parameter of the single unit as Master (In = 1) or Slave (In = 0)	IN ⁴	0	1				

	RTC PARAMETERS (only on Master unit)	Type	Min.	Max.	UOM	Def.	To LAN	New
hh	Current hour	F	0	23	hours	-		
mm	Current minute	F	0	59	min.	-		
h1	Hour of the first defrost	C	0	23	hours	24		
m1	Minute (of hour h1 on the current day) when a defrost starts	C	0	50	min.	0		
h2	Hour of the second defrost	C	0	23	hours	24		
m2	Minute (of hour h2 on the current day) when a defrost starts	C	0	50	min.	0		
----	-----	-----	-----	-----	-----	----		
----	-----	-----	-----	-----	-----	----		
h8	Hour of the eighth defrost	C	0	23	hours	24		
m8	Minute (of hour h8 on the current day) when a defrost starts	C	0	50	min.	0		

⁴ The IN parameters are accessible only when starting the machine by pressing the PRG & SEL buttons during the POWER ON phase during which the 3 hyphens “-” and a code identifying the unit as Master (uM) or slave u? (? = 1 ... 5: address of the slave in the LAN) are displayed.

CAREL

Technology & Evolution

CAREL srl

Via dell'Industria, 11 - 35020 Brugine - Padova (Italy)

Tel. (+39) 049.9716611 Fax (+39) 049.9716600

<http://www.carel.com> - e-mail: carel@carel.com

Agency:

cod. +030220191 (preliminary version) rel. 2.025/06/01