

ir33 platform

connessioni / connections

CAREL

ir33
ir33 power
ir33 DIN
powercompact
powercompact small
mastercella



~~Ⓡ~~ Manuale d'uso

Ⓡ User manual

→ **LEGGI E CONSERVA
QUESTE ISTRUZIONI** ←
**READ AND SAVE
THESE INSTRUCTIONS**

User manual



We wish to save you time and money!
We can assure you that the thorough reading of this manual will guarantee correct installation and safe use of the product described.



IMPORTANT WARNINGS

CAREL bases the development of its products on decades of experience in HVAC, on the continuous investments in technological innovations to products, procedures and strict quality processes with in-circuit and functional testing on 100% of its products, and on the most innovative production technology available on the market.

CAREL and its subsidiaries nonetheless cannot guarantee that all the aspects of the product and the software included with the product respond to the requirements of the final application, despite the product being developed according to start-of-the-art techniques. The customer (manufacturer, developer or installer of the final equipment) accepts all liability and risk relating to the configuration of the product in order to reach the expected results in relation to the specific final installation and/or equipment. CAREL may, based on specific agreements, act as a consultant for the positive commissioning of the final unit/application, however in no case does it accept liability for the correct operation of the final equipment/system.

The CAREL product is a state-of-the-art product, whose operation is specified in the technical documentation supplied with the product or can be downloaded, even prior to purchase, from the website www.carel.com.

Each CAREL product, in relation to its advanced level of technology, requires setup/configuration/programming/commissioning to be able to operate in the best possible way for the specific application. The failure to complete such operations, which are required/indicated in the user manual, may cause the final product to malfunction; CAREL accepts no liability in such cases.

Only qualified personnel may install or carry out technical service on the product.

The customer must only use the product in the manner described in the documentation relating to the product.

In addition to observing any further warnings described in this manual, the following warnings must be heeded for all CAREL products:

- Prevent the electronic circuits from getting wet. Rain, humidity and all types of liquids or condensate contain corrosive minerals that may damage the electronic circuits. In any case, the product should be used or stored in environments that comply with the temperature and humidity limits specified in the manual.
- Do not install the device in particularly hot environments. Too high temperatures may reduce the life of electronic devices, damage them and deform or melt the plastic parts. In any case, the product should be used or stored in environments that comply with the temperature and humidity limits specified in the manual.
- Do not attempt to open the device in any way other than described in the manual.
- Do not drop, hit or shake the device, as the internal circuits and mechanisms may be irreparably damaged.
- Do not use corrosive chemicals, solvents or aggressive detergents to clean the device.
- Do not use the product for applications other than those specified in the technical manual.

All of the above suggestions likewise apply to the controllers, serial boards, programming keys or any other accessory in the CAREL product portfolio.

CAREL adopts a policy of continual development. Consequently, CAREL reserves the right to make changes and improvements to any product described in this document without prior warning.

The technical specifications shown in the manual may be changed without prior warning.

The liability of CAREL in relation to its products is specified in the CAREL general contract conditions, available on the website www.carel.com and/or by specific agreements with customers; specifically, to the extent where allowed by applicable legislation, in no case will CAREL, its employees or subsidiaries be liable for any lost earnings or sales, losses of data and information, costs of replacement goods or services, damage to things or people, downtime or any direct, indirect, incidental, actual, punitive, exemplary, special or consequential damage of any kind whatsoever, whether contractual, extra-contractual or due to negligence, or any other liabilities deriving from the installation, use or impossibility to use the product, even if CAREL or its subsidiaries are warned of the possibility of such damage.



Disposing of the parts of the controller:

The controller is made up of metal and plastic parts and a lithium battery. All these parts must be disposed of separately in compliance with the local standards in force on waste disposal.

Contents

1. POWERCOMPACT	7
1.1 Dimensions.....	7
1.2 Electrical specifications.....	7
1.3 Electrical connections.....	9
2. POWERCOMPACT SMALL	10
2.1 Dimensions.....	10
2.2 Electrical specifications.....	10
1.3 Electrical connections.....	12
3. MASTERCELLA 2	13
3.1 Dimensions.....	13
3.2 Technical specifications.....	13
3.3 Electrical connections.....	14
4. IR33	15
4.1 Dimensions.....	15
4.2 Electrical specifications.....	15
4.3 Electrical connections.....	17
5. IR33POWER	19
5.1 Dimensions.....	19
5.2 Electrical specifications.....	19
5.3 Electrical connections.....	21
6. IR33DIN	22
6.1 Dimensions.....	22
6.2 Electrical specifications.....	22
6.3 Electrical connections.....	24

1. POWERCOMPACT

1.1 Dimensions

Appearance and ergonomics:

The appearance has been designed to fit in harmoniously with the new lines of the refrigeration units.

The main characteristic is its compactness: the dimensions are in fact 167x 36 x75 mm in the standard version.

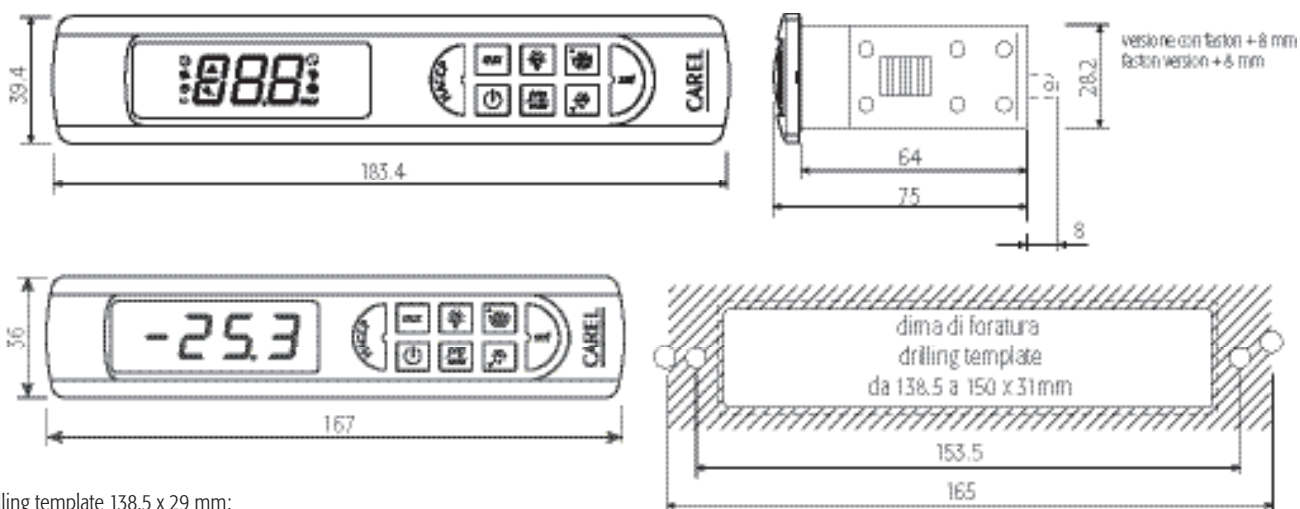

Key:

1. drilling template 138.5 x 29 mm;
2. faston (spade) version + 8 mm

Fig. 1.a

1.2 Electrical specifications

Power supply	model E:	voltage 230 V~ 50/60 Hz; 230 V~ 50/60 Hz, 16 A, 8 A, 8 A version;	power 3 VA, 25 mA~ max 3 VA, 25 mA~ max
	model A:	115 V~ 50/60 Hz; 115 V~ 50/60 Hz, 16 A, 8 A, 8 A version;	3 VA, 50 mA~ max 3 VA, 50 mA~ max
	model H:	115-230 Vac 50/60Hz	6 VA, 50mA~ max
	model 0:	12 V~ , 50/60Hz 12 Vdc, 12-18Vdc	4 VA, 300 mA~ max TRADR4W012 transformer, 315 mA slow-blow fuse in secondary, only use SELV power supply
Insulation guaranteed by the power supply	model E, A, H:	voltage insulation from very low voltage parts insulation from relay outputs	power reinforced.; 6 mm air, 8 mm surface; 3750 V insulation basic; 3 mm air, 4 mm surface; 1250 V insulation
	model 0:	insulation from very low voltage parts insulation from relay outputs	to be guaranteed externally by safety transformer basic; 3 mm air, 4 mm surface; 1250 V insulation
Inputs	S1	NTC or PTC, depending on the model	
	S2	NTC or PTC, depending on the model	
	D11	voltage-free contact, contact resistance < 10 ohm, closing current 6 mA	
	S3	NTC or PTC, depending on the model	
	D12	voltage-free contact, contact resistance < 10 ohm, closing current 6 mA	
	S4	NTC or PTC, depending on the model	
	Maximum distance between probes and digital inputs less than 10 m Note: in the installation, keep the power supply and load connections separate from the probe, digital inputs, repeater display and supervisor cables.		
Type of probe	Std. Carel NTC	10 kΩ at 25 °C, range -50T90 °C measurement error: 1 °C in the range -50T50 °C 3 °C in the range +50T90 °C	
	High temperature NTC	50 kΩ at 25 °C, range -40T150 °C measurement error: 1.5 °C in the range -20T115 °C 4 °C in the range outside of -20T115 °C	
	Std. Carel PTC (specific model)	985 Ω at 25°C, range -50T150 °C measurement error: 2 °C in the range -50T50 °C 4 °C in the range +50T150 °C	

Relay outputs	depending on the model		
	5 A	EN60730-1: 250 V~ 5 (1) A; UL 873: 250 V~ 5A res 1FLA 6LRA C300;	100,000 operating cycles 30,000 operating cycles
	8 A	EN60730-1: 250 V~ 8 (4) on N.O., 6 (4) on N.C., 2 (2) on N.O. and N.C.; UL 873: 250 V~ 8A res 2FLA 12LRA C300;	100,000 operating cycles 30,000 operating cycles
	16 A	EN60730-1: 250 V~ 10 (4) A up to 60°C on N.O., 12 (2) A on N.O. and N.C.; UL 873: 250 V~ 12A res 5FLA 30LRA C300;	100,000 operating cycles 30,000 operating cycles
	2HP	EN60730-1: 250 V~ 10 (10) A; UL 873: 250 V~ 12A res 12FLA 72LRA;	100,000 operating cycles 30,000 operating cycles
		insulation from very low voltage parts	reinforced; 6 mm air, 8 mm surface; 3750 V insulation
	insulation between the relay outputs	basic; 3 mm air, 4 mm surface; 1250 V insulation	
Connections	Type of connection fixed screw plug-in for screw blocks spade with crimped contact	Cross-sections for cables from 0.5 to 2.5 mm ²	Maximum current 12A
	The correct sizing of the power and connection cables between the instrument and the loads is the responsibility of the installer. In the max load and max operating temp. conditions, the cables used must be suitable for operation up to 105°C.		
Case	plastic: dimensions 36x167x75 mm; mounting depth 64 mm		
Assembly	smooth, hard and indeformable panel: using screws from the front		
	drilling template: dimensions 29x138.5 mm; distance between fastening screws 153.5mm		
	fastening screws: countersunk head with maximum thread diameter 3.9mm		
Wide vers. case (power supply E, A, H, O)	plastic	dimensions: 39.4x183x75 mounting depth 63 mm	
Assembly	smooth, hard and indeformable panel	using screws from the front or brackets	
(power supply E, A, H, O)	drilling template	dimensions: from 138.5x29 to 150x31	
Wide versions		distance between fastening screws: 165 mm or 153.5	
Display	digits: 3 digit LED		
	display: from -99 to 999		
	operating status: indicated with graphic icons on the display		
Keypad	8 silicone rubber buttons		
Infrared receiver	available depending on the model		
Clock with backup battery	available depending on the model		
Buzzer	available in all models		
Clock	Error at 25 °C:	± 10 ppm (±5.3 min/year)	
	Error in the temperature range -10T60 °C:	- 50ppm (-27min/year)	
	Ageing:	< ±5p pm (±2.7 min/year)	
	Discharge time:	typically 6 months (8 months maximum)	
	Recharge time:	typically 5 hours (< 8 hours maximum)	
Operating conditions	-10T65 °C; <90% RH non-condensing		
Storage conditions	-20T70 °C; <90% RH non-condensing		
Front panel index of protection	assembly on smooth and indeformable panel with IP65 gasket		
Environmental pollution	2, normal situation		
PTI of insulating materials	printed circuits 250, plastic and insulating materials 175		
Period of stress across the insulating parts	long		
Category of resistance to fire	category D and category B (UL 94-V0)		
Class of protection against voltage surges	category II		
Type of action and disconnection	1B relay contacts (micro-disconnection)		
Construction of the control device	electronic control device incorporated		
Classification according to protection against electric shock	class II when appropriately integrated		
Device designed to be hand-held or integrated into equipment designed to be hand-held	no		
Software class and structure	class A		
Cleaning the front panel of the instrument	only use neutral detergents and water		
Serial interface for CAREL network	External, available in all models		
Interface for repeater display	External, available in models with H and O power supplies		
Maximum distance between interface and display	10 m		
Programming key	Available in all models		
	fastening screws	countersunk head with maximum thread diameter 3.9 mm for 165 mm spacing flat head for 153 mm spacing, maximum thread diameter 3 mm	

Table 1.a

1.3 Electrical connections

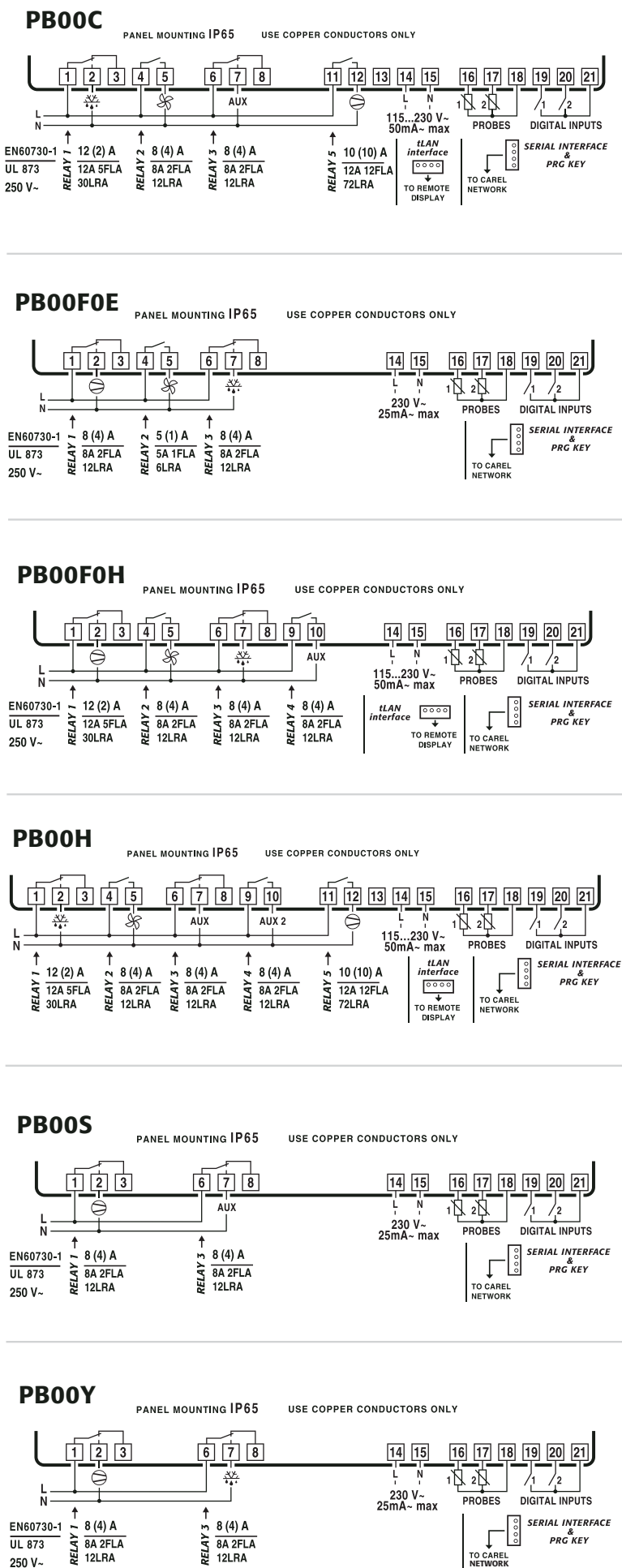

Fig. 2.b

2. POWERCOMPACT SMALL

2.1 Dimensions

Appearance and ergonomics:

The appearance has been designed to fit in harmoniously with the new lines of the refrigeration units.

The main characteristic is its compactness: the dimensions are 167 x 36 x 51 mm.

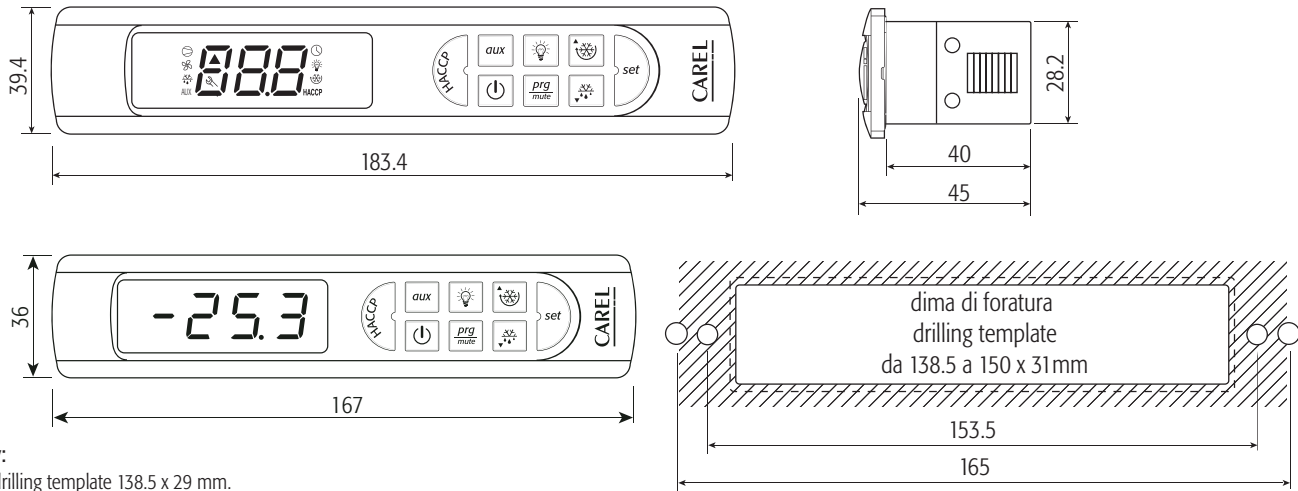

Key:

1. drilling template 138.5 x 29 mm.

Fig. 2.a

2.2 Electrical specifications

	voltage	power
Power supply	model S: 115 - 230 V~ 50/60 Hz;	6 VA, 50 mA~ max
Insulation guaranteed by the power supply	insulation from very low voltage parts	reinforced; 6 mm air, 8 mm surface; 3750 V insulation
	insulation from relay outputs	basic; 3 mm air, 4 mm surface; 1250 V insulation
Inputs	S1 NTC or PTC, depending on the model	
	S2 NTC or PTC, depending on the model	
	DI1 voltage-free contact, contact resistance < 10 ohm, closing current 6 mA	
	S3 NTC or PTC, depending on the model	
	DI2 voltage-free contact, contact resistance < 10 ohm, closing current 6 mA	
	S4 NTC or PTC, depending on the model	
	Maximum distance between probes and digital inputs less than 10 m. Note: in the installation, keep the power supply and load connections separate from the probe, digital inputs, repeater display and supervisor cables.	
Type of probe	Std. Carel NTC	10 kΩ at 25 °C, range -50 to 90 °C measurement error: 1 °C in the range -50 to 50 °C 3 °C in the range +50 to 90 °C
	High temperature NTC	50 kΩ at 25 °C, range -40 to 150 °C measurement error: 1.5 °C in the range -20 to 115 °C 4 °C in the range outside of -20 to 115 °C
	Std. Carel PTC (specific model)	985 Ω at 25°C, range -50 to 150 °C measurement error: 2 °C in the range -50 to 50 °C 4 °C in the range +50 to 150 °C
Relay outputs	depending on the model	
	5 A EN60730-1: 250 V~ 5 (1) A; UL 873: 250 V~ 5A res 1FLA 6LRA C300;	100,000 operating cycles 30,000 operating cycles
	8 A EN60730-1: 250 V~ 8 (4) on N.O., 6 (4) on N.C., 2 (2) on N.O. and N.C.; UL 873: 250 V~ 8A res 2FLA 12LRA C300;	100,000 operating cycles 30,000 operating cycles
	30 A EN60730-1: 250 V~ 12 (10) A; UL 873: 250 V~ 12A res 2HP 72LRA;	100,000 operating cycles 30,000 operating cycles
	insulation from very low voltage parts	reinforced; 6 mm air, 8 mm surface; 3750 V insulation
	insulation between the relay outputs	basic; 3 mm air, 4 mm surface; 1250 V insulation
Connections	Type of connection fixed screw plug-in for screw blocks fixed screw vertical spade with crimped contact	Cross-sections for cables from 0.5 to 2.5 mm ²
		Maximum current 12A
	The correct sizing of the power and connection cables between the instrument and the loads is the responsibility of the installer. Maximum current at terminals 4 and 7 is 12A. In the max load and max operating temp. conditions, the cables used must be suitable for operation up to 105°C.	

Case	plastic: dimensions 36x167x45 mm; mounting depth 40 mm	
Assembly	smooth, hard and indeformable panel: using screws from the front	
	drilling template: dimensions 29x138.5 mm; distance between fastening screws 153.5 mm	
	fastening screws: countersunk head with maximum thread diameter 3.9 mm	
Wide vers. case (power supply S)	plastic	dimensions: 39.4x183x45 mounting depth 40 mm
Assembly (power supply S)	smooth, hard and indeformable panel	using screws from the front or brackets
Wide versions	drilling template	dimensions: from 138.5x29 to 150x31
	fastening screws	distance between fastening screws: 165 mm or 153.5 countersunk head with maximum thread diameter 3.9 mm for 165 mm spacing flat head for 153 mm spacing, maximum thread diameter 3 mm
Display	digits: 3 digit LED	
	display: from -99 to 999	
	operating status: indicated with graphic icons on the display	
Keypad	8 silicone rubber buttons	
Infrared receiver	available depending on the model	
Clock with backup battery	available depending on the model	
Buzzer	available in all models	
Clock	Error at 25 °C:	± 10 ppm (±5.3 min/year)
	Error in the temperature range -10T60 °C:	- 50ppm (-27min/year)
	Ageing:	< ±5p pm (±2.7 min/year)
	Discharge time:	typically 6 months (8 months maximum)
	Recharge time:	typically 5 hours (< 8 hours maximum)
Operating conditions	-10T65 °C; <90% RH non-condensing	
Storage conditions	-20T70 °C; <90% RH non-condensing	
Front panel index of protection	assembly on smooth and indeformable panel with IP65 gasket	
Environmental pollution	2, normal situation	
PTI of insulating materials	printed circuits 250, plastic and insulating materials 175	
Period of stress across the insulating parts	long	
Category of resistance to fire	category D and category B (UL 94-V0)	
Class of protection against voltage surges	category II	
Type of action and disconnection	1B relay contacts (micro-disconnection)	
Construction of the control device	electronic control device incorporated	
Classification according to protection against electric shock	to be integrated into class I appliances	
Device designed to be hand-held or integrated into equipment designed to be hand-held	no	
Software class and structure	class A	
Cleaning the front panel of the instrument	only use neutral detergents and water	
Serial interface for CAREL network	External, available in all models	
Interface for repeater display	External, available in all models	
Maximum distance between interface and display	10 m	
Programming key	Available in all models	

Table 2.a

1.3 Electrical connections

PB00S

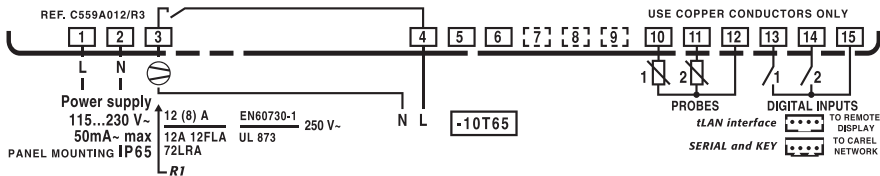

PB00S

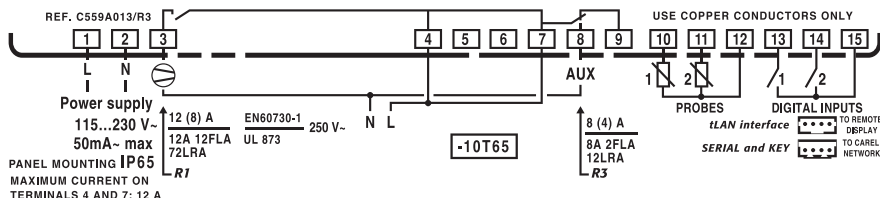

PB00Y

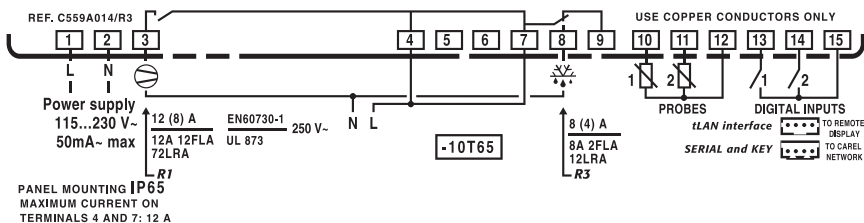

PB00Y

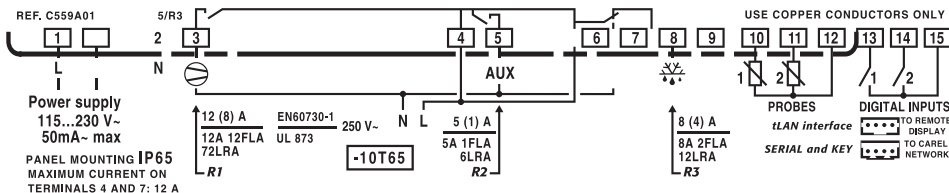

PB00F

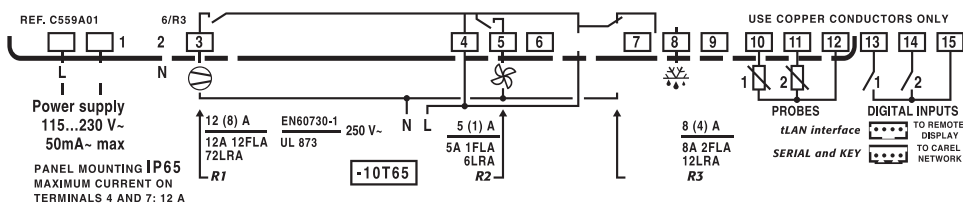

PB00C

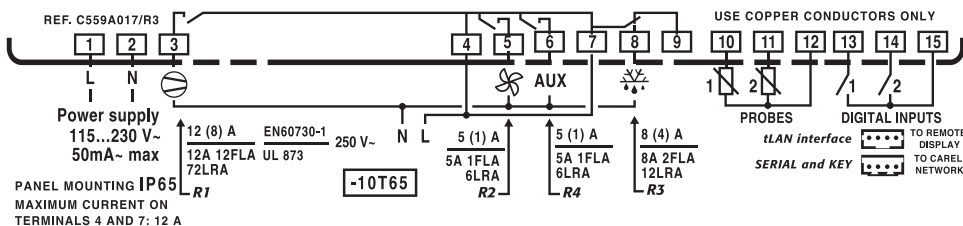

Fig. 2.b

3. MASTERCELLA 2

3.1 Dimensions

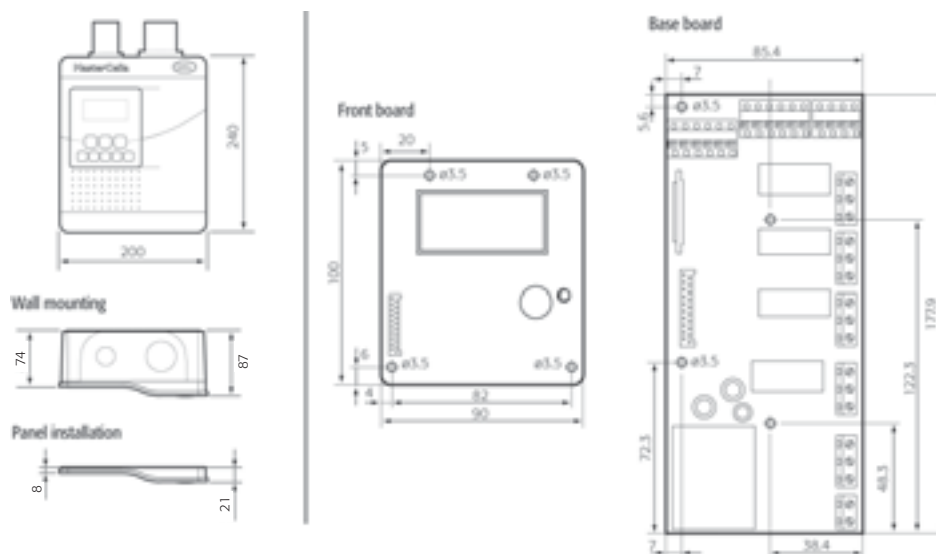

Fig. 3.a

3.2 Technical specifications

Power supply	voltage	power	
	model E: 230 V~ 50/60 Hz;	11,3 VA, 50 mA~ max	
	model A: 115 V~ 50/60 Hz;	11,3 VA, 100 mA~ max	
Insulation guaranteed by the power supply	voltage	power	
	model E, A: insulation from very low voltage parts insulation from relay outputs	reinforced; 6 mm air, 8 mm surface; 3750 V insulation basic; 3 mm air, 4 mm surface; 1250 V insulation	
Inputs	S1	NTC or PTC, depending on the model	
	S2	NTC or PTC, depending on the model	
	DI1	voltage-free contact, contact resistance < 10 ohm, closing current 6 mA	
	S3	NTC or PTC, depending on the model	
	DI2	voltage-free contact, contact resistance < 10 ohm, closing current 6 mA	
	S4	NTC or PTC, depending on the model	
	DI3	voltage-free contact, contact resistance < 10 ohm, closing current 6 mA	
	S5	NTC or PTC, depending on the model	
	Maximum distance between probes and digital inputs less than 10 m. Note: in the installation, keep the power supply and load connections separate from the probe, digital inputs, repeater display and supervisor cables.		
Type of probe	Std. Carel NTC	10 kΩ at 25 °C, range -50 to 90 °C measurement error: 1 °C in the range -50 to 50 °C 3 °C in the range +50 to 90 °C	
	High temperature NTC	50 kΩ at 25 °C, range -40 to 150 °C measurement error: 1.5 °C in the range -20 to 115 °C 4 °C in the range outside of -20 to 115 °C	
	Std. Carel PTC (specific model)	985 Ω at 25°C, range -50 to 150 °C measurement error: 2 °C in the range -50 to 50 °C 4 °C in the range +50 to 150 °C	
Relay outputs	depending on the model		
	8 A	EN60730-1: 250 V~ 8 (4) on N.O., 6 (4) on N.C., 2 (2) on N.O. and N.C.; 100,000 operating cycles UL 873: 250 V~ 8A res 2FLA 12LRA C300; 30,000 operating cycles	
	16 A	EN60730-1: 250 V~ 10 (4) A up to 60°C on N.O., 12 (2) A on N.O. and N.C.; 100,000 operating cycles UL 873: 250 V~ 12A res 5FLA 30LRA C300; 30,000 operating cycles	
	2HP	EN60730-1: 250 V~ 10 (10) A; 100,000 operating cycles UL 873: 250 V~ 12A res 12FLA 72LRA; 30,000 operating cycles	
	30 A	EN60730-1: 250 V~ 12 (10) A; 100,000 operating cycles UL 873: 250 V~ 12A res 2HP 72LRA; 30,000 operating cycles	
		insulation from very low voltage parts reinforced; 6 mm air, 8 mm surface; 3750 V insulation insulation between the relay outputs basic; 3 mm air, 4 mm surface; 1250 V insulation	
Connections	Type of connection	Cross-sections	Maximum current
	fixed screw	for cables from 0.5 to 2.5 mm ²	12A
	plug-in for screw blocks		
	spade with crimped contact		
	wire cross-section for probes and digital inputs: 0.25 to 2.5 mm ² (from 20 to 13 AWG)		
	wire cross-section per power supply and loads: 1.5 to 2.5 mm ² (from 15 to 13 AWG)		
	The correct sizing of the power and connection cables between the instrument and the loads is the responsibility of the installer. In the max load and max operating temp. conditions, the cables used must be suitable for operation up to 105°C.		
Case	plastic: dimensions 200x240x87 mm; mounting depth 64 mm		
	open main board and front panel: base dimensions 178x86x40 mm; front panel dimensions 100x90x12 mm		

Assembly	wall mounting (with plastic case):	using fastening screws;	spacing 162.5x218.5 mm
	panel installation (with plastic front panel):	using fastening screws;	spacing 159.5x197.5 mm
	open board:	using fastening screws for main board and front panel	
Display	digits: 3 digit LED		
	display: from -99 to 999		
	operating status: indicated with LEDs and graphic icons made in the polycarbonate label applied to the plastic case		
Keypad	8 mechanical buttons, keypad made in the polycarbonate label applied to the plastic case		
Infrared receiver	available depending on the model		
Clock with backup battery	available depending on the model		
Buzzer	available in all models		
Clock	Error at 25 °C:	± 10 ppm	(±5.3 min/year)
	Error in the temperature range -10T60 °C:	- 50 ppm	(-27min/year)
	Ageing:	< ± 5 ppm	(±2.7 min/year)
	Discharge time:	typically 6 months (8 months maximum)	
	Recharge time:	typically 5 hours (< 8 hours maximum)	
Operating conditions	open board:	-10T65 °C; <90% RH non-condensing	
	with plastic case: With the following current configurations:	-10T50 °C; <90% RH non-condensing Relay 1 12 A, Relay 2 0 A, Relay 3 4 A, Relay 4 4 A, Relay 5 4 A Relay 1 0 A, Relay 2 12 A, Relay 3 4 A, Relay 4 4 A, Relay 5 4 A	
The currents indicated above will be reduced according to the relays used.			
Storage conditions	-20T70 °C; <90% RH non-condensing		
Front panel index of protection	with plastic case	IP65 without disconnecting switch	
	panel installation with plastic front panel	IP54 with disconnecting switch	
Environmental pollution	2, normal situation		
PTI of insulating materials	printed circuits 250, plastic and insulating materials 175		
Period of stress across the insulating parts	long		
Category of resistance to fire	category D and category B (UL 94-V0)		
Class of protection against voltage surges	category II		
Type of action and disconnection	1B relay contacts (micro-disconnection)		
Construction of the control device	electronic control device incorporated		
Classification according to protection against electric shock	class II when appropriately integrated		
Device designed to be hand-held or integrated into equipment designed to be hand-held	no		
Software class and structure	class A		
Cleaning the front panel of the instrument	only use neutral detergents and water		
Serial interface for CAREL network	Built-in, available in all models, upon request		
Interface for repeater display	Built-in, available in all models, upon request		
Maximum distance between interface and display	10 m		
Programming key	Available in all models		

Table 3.a

3.3 Electrical connections

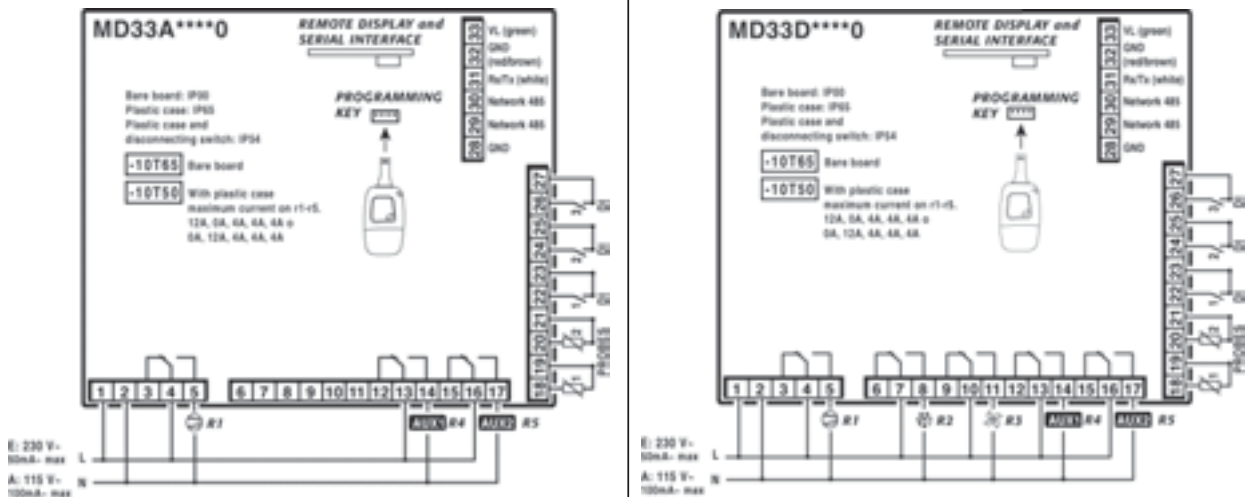

Fig. 3.b

4. IR33

4.1 Dimensions

Appearance and ergonomics:

The appearance has been designed to fit in harmoniously with the new lines of the refrigeration units.

The main characteristic is its compactness: the dimensions are in fact 34.4 x 76.2 x 65 mm, and 34.4 x 76.2 x 79 mm for the version with traditional transformer.

The drilling templates for both versions are 29 x 71 mm.

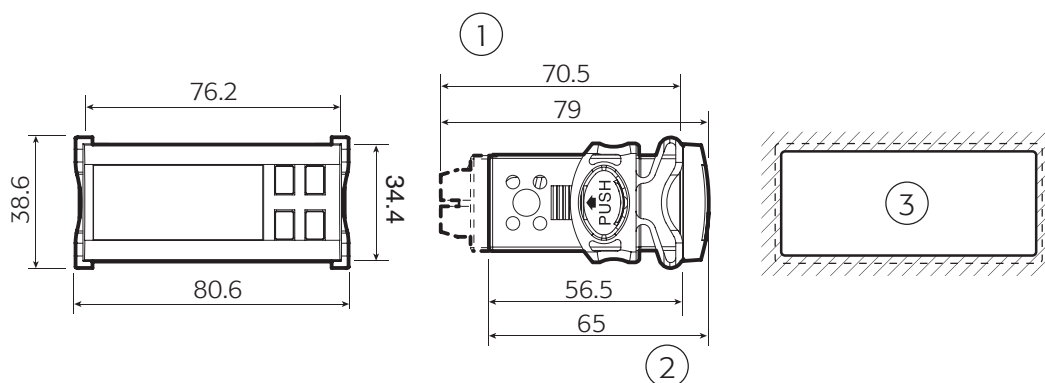

Key:

- 1. version O, L, H;
- 2. version E, A;
- 3. drilling template 71x29 mm

Fig. 4.a

4.2 Electrical specifications

Power supply	E:	voltage 230 V~ 50/60 Hz;	power 3 VA, 25 mA~ max
	A:	115 V~ 50/60 Hz;	3 VA, 50 mA~ max
Insulation guaranteed by the power supply	E, A:	voltage insulation from very low voltage parts insulation from relay outputs for model E, A, for I, L, M, N connections only	power reinforced; 6 mm air, 8 mm surface; 3750 V insulation
		insulation from relay outputs for model E, A, for A, B, C, D, E, F, G, H connections only	basic; 3 mm air, 4 mm surface; 1250 V insulation
			basic; 3 mm air, 4 mm surface; 1250 V insulation
Inputs	S1	NTC or PTC, depending on the model	
	S2	NTC or PTC, depending on the model	
	D11	voltage-free contact, contact resistance < 10Ω, closing current 6 mA NTC or PTC	
	S3	depending on the model	
	D12	voltage-free contact, contact resistance < 10Ω, closing current 6 mA NTC or PTC	
	S4	depending on the model	
	Maximum distance between probes and digital inputs less than 10 m Note: in the installation, keep the power supply and load connections separate from the probe, digital inputs, repeater display and supervisor cables.		
Type of probe	Standard Carel NTC	10 kΩ at 25 °C, range -50T90 °C measurement error: 1 °C in the range -50T50 °C 3 °C in the range +50T90 °C	
	High temperature NTC	50 kΩ at 25 °C, range -40T150 °C measurement error: 1.5 °C in the range -20T115 °C 4 °C in the range outside of -20T115 °C	
	Standard Carel PTC (specific model)	985 Ω at 25°C, range -50T150 °C measurement error: 2 °C in the range -50T50 °C 4 °C in the range +50T150 °C	
Relay outputs	depending on the model		
	EN60730-1:	relay R3 250 V~ ; 5 (1) A;	100,000 operating cycles
	UL 873:	relay R3 250 V~ 1 A resistive 1FLA 6LRA C300;	30,000 operating cycles
	EN60730-1:	relay R2 250 V~ 8(4) A on N.O., 6(4) A on N.C., 2 (2) A on N.O. and N.C.;	100,000 operating cycles
	UL 873:	relay R2 250 V~ 8 A res 2FLA 12LRA C300;	30,000 operating cycles
	EN60730-1:	relay R1 250 V~ 12 (10) A	100,000 operating cycles
UL 873:	relay R1 250 V~ 12A res 2Hp 12 FLA	300,00 operating cycles	
insulation from very low voltage parts		reinforced; 6 mm air, 8 mm surface; 3750 V insulation	

Connections	Type of connection	Cross-sections	Max current.
	fixed screw 16A	for cables from 0.5 to 4.2 mm ²	16A
	fixed screw estraiibili per blocchetti a vite	for cables from 0.5 to 2.5 mm ²	12A
	The correct sizing of the power and connection cables between the instrument and the loads is the responsibility of the installer. Depending on the model, the maximum current at the common terminals is 12A or 16A. In the max load and max operating temp. conditions, the cables used must be suitable for operation up to 105°C.		
Case	plastic: E, A dimensions 34.4x76.2x65 mm - mounting depth 56.5 mm		
Assembly	smooth, hard and indeformable panel: side fastening brackets, to be pressed in fully drilling template: dimensions 28.8 ± 0.2 x 70.8 ± 0.2 mm		
Display	digits: 3 digit LED display: from -99 to 999 operating status: indicated with graphic icons on the display		
Keypad	4 silicone rubber buttons		
Infrared receiver	available depending on the model		
Clock with backup battery	available depending on the model		
Buzzer	available in all models		
Clock	error at 25 °C:	± 10 ppm (±5.3 min/year)	
	error in the temperature range -10T60 °C:	- 50 ppm (-27min/year)	
	ageing:	< ± 5 ppm (±2.7 min/year)	
	discharge time:	typically 6 months (8 months maximum)	
	recharge time:	typically 5 hours (< 8 hours maximum)	
Operating temperature	-10T60 °C; with max current 16 A -10T50°C; with max current 24 A (E, F, G, H connections)		
Operating humidity	<90% RH non-condensing		
Storage temperature	-20T70 °C		
Front panel index of protection	assembly on smooth and indeformable panel with IP65 gasket		
Environmental pollution	2, normal situation		
PTI of insulating materials	printed circuits 250, plastic and insulating materials 175		
Period of stress across the insulating parts	long		
Category of resistance to fire	category D and category B (UL 94-V0)		
Class of protection against voltage surges	category II		
Type of action and disconnection	1B relay contacts (micro-disconnection)		
Construction of the control device	electronic control device incorporated		
Classification according to protection against electric shock	class II when appropriately integrated		
Device designed to be hand-held or integrated into equipment designed to be hand-held	no		
Software class and structure	class A		
Cleaning the front panel of the instrument	only use neutral detergents and water		
Serial interface for CAREL network	External, available in all models		
Programming key	Available in all models		

Table 4.a

4.3 Electrical connections

IRxxC(0,7) H (N,R,C,B) (0,2)xx

Maximum total current on terminal 3: 12 A

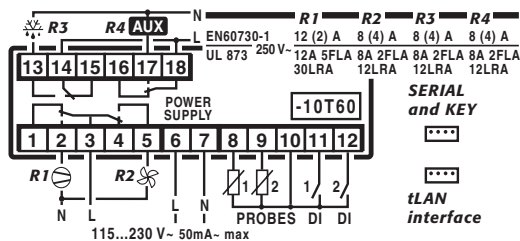

IRxxC(0,7) (0,L) (N,R,C,B) (0,2)xx

Maximum total current on terminal 3: 12 A

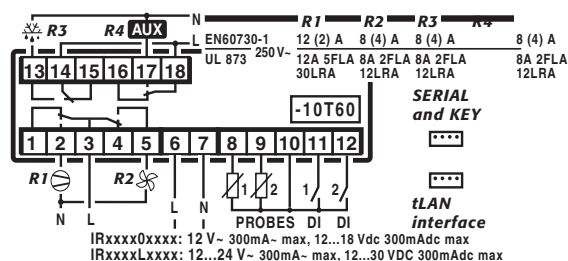

IRxxF(0,7) (E,A) (N,R,C,B) (0,1,2,3,5)xx

Maximum total current on terminal 1: 12 A

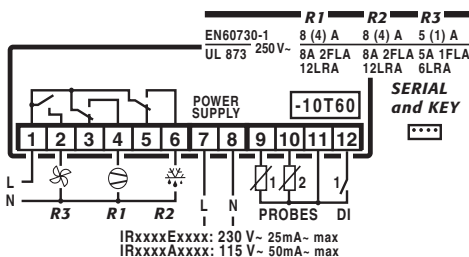

IRxxF(0,7) H (N,R,C,B) (0,2)xx

Maximum total current on terminal 3: 12 A

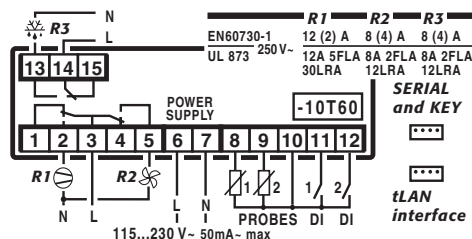

IRxxF(0,7) (0,L) (N,R,C,B) (0,2)xx

Maximum total current on terminal 3: 12 A

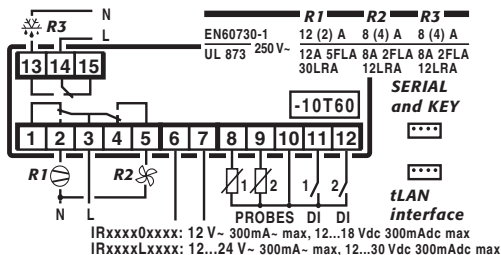

IRxxM(0,7) (E,A,0) (N,R,C,B) (0,1,2,3,5)xx (NO R1)

IRxxM(0,7) (E,A) (A,M,L,T) (0,1,2,3,5)xx

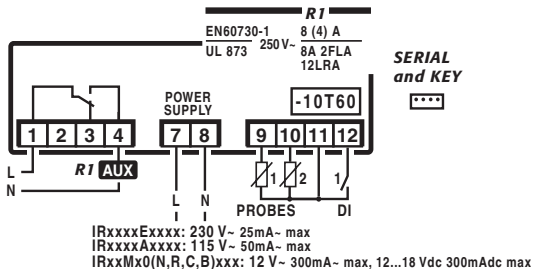

IRxxM(0,7) (L) (N,R,C,B) (0,2)xx (NO R1)

IRxxM(0,7) (0,L) (A,M,L,T) (0,2)xx

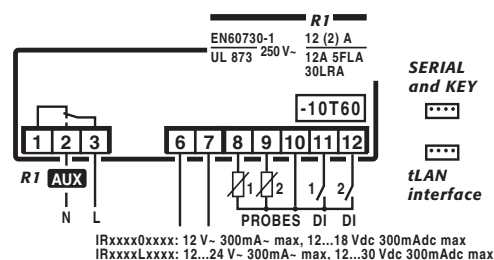

IRxxS(0,7) (E,A) (N,R,C,B) (0,1,2,3,5)xx (NO R2)
IRxxS(0,7) (E,A) (A,M,L,T) (0,1,2,3,5)xx

Maximum total current on terminal 1: 12 A

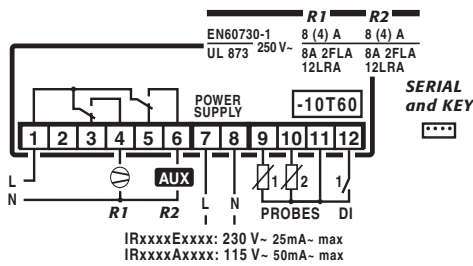

IRxxS(0,7) (E,A) (P,Q,S,U) (0,1,2,3,5)xx (NO R2)
IRxxS(0,7) (E,A) (V,X,Y,Z) (0,1,2,3,5)xx

Maximum total current on terminal 5: 12 A

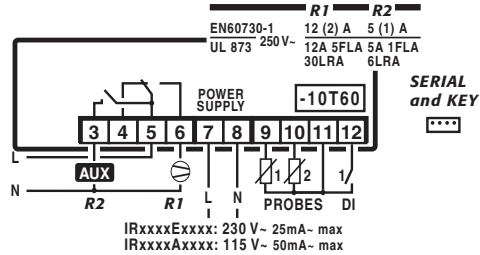

IRxxS(0,7) H (A,M,L,T) (0,2) xx

Maximum total current on terminal 3: 12 A

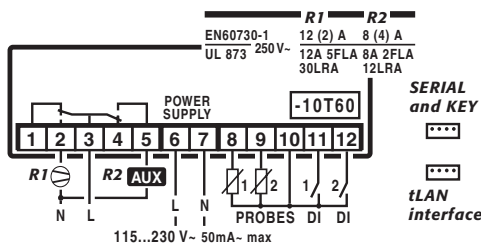

IRxxS(0,7) (0,L) (N,R,C,B) (0,2)xx (NO R3)
IRxxS(0,7) (0,L) (A,M,L,T) (0,2)xx

Maximum total current on terminal 3: 12 A

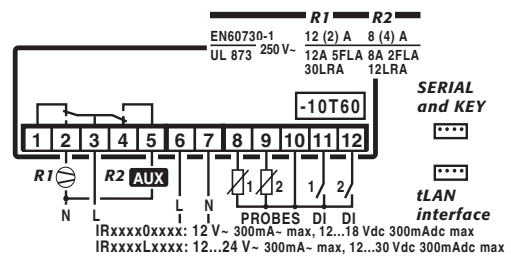

IRxxY(0,7) (E,A) (N,R,C,B) (0,1,2,3,5)xx (NO R2)
IRxxY(0,7) (E,A) (A,M,L,T) (0,1,2,3,5)xx

Maximum total current on terminal 1: 12 A

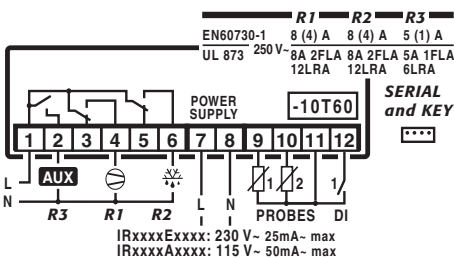

IRxxY(0,7) (E,A) (P,Q,S,U) (0,1,2,3,5)xx

Maximum total current on terminal 5: 12 A

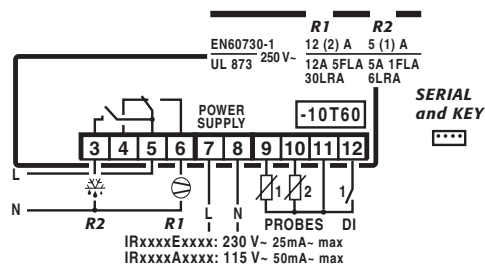

IRxxY(0,7) H (N,R,C,B) (0,2)xx (NO R3)
IRxxY(0,7) H (A,M,L,T) (0,2)xx

Maximum total current on terminal 3: 12 A

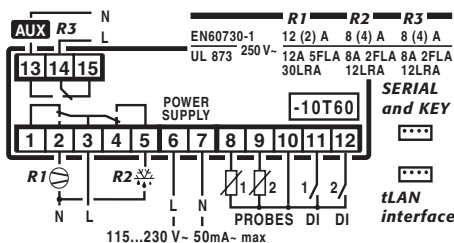

IRxxY(0,7) (0,L) (N,R,C,B) (0,2)xx (NO R3)
IRxxY(0,7) (0,L) (A,M,L,T) (0,2)xx

Maximum total current on terminal 3: 12 A

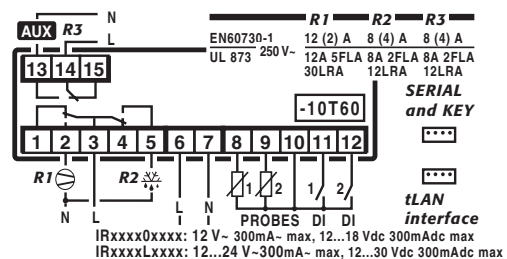

Fig. 4.b

5. IR33POWER

5.1 Dimensions

See "Dimensions" for the chapter on the ir33.

5.2 Electrical specifications

Power supply	voltage	power	
	model E: 230 V~ 50/60 Hz;	3 VA, 25 mA~ max	
	model A: 115 V~ 50/60 Hz;	3 VA, 50 mA~ max	
Insulation guaranteed by the power supply	voltage	power	
	model E, A, H: insulation from very low voltage parts: reinforced; 6 mm air, 8 mm surface; 3750 V insulation insulation from relay outputs for model E, A for I, L, M, N connections only: basic; 3 mm air, 4 mm surface; 1250 V insulation insulation from relay outputs with model E, A for A, B, C, D connections only: Do not insulate from the power supply as one phase is taken from the relay common		
Inputs	S1	NTC or PTC, depending on the model	
	S2	NTC or PTC, depending on the model	
	D11	voltage-free contact, contact resistance < 10 ohm, closing current 6 mA	
	S3	NTC or PTC, depending on the model	
	D12	voltage-free contact, contact resistance < 10 ohm, closing current 6 mA	
	S4	NTC or PTC, depending on the model	
	Maximum distance between probes and digital inputs less than 10 m. Note: in the installation, keep the power supply and load connections separate from the probe, digital inputs, repeater display and supervisor cables.		
Type of probe	NTC std. Carel	10 kΩ at 25 °C, range -50 to 90 °C measurement error: 1 °C in the range -50 to 50 °C 3 °C in the range +50 to 90 °C	
	High temperature NTC	50 kΩ at 25 °C, range -40 to 150 °C measurement error: 1.5 °C in the range -20 to 115 °C 4 °C C in the range outside of -20 to 115 °C	
	Std. Carel PTC (specific model)	985 Ω at 25°C, range -50 to 150 °C measurement error: 2 °C in the range -50 to 50 °C 4 °C in the range +50 to 150 °C	
Relay outputs	depending on the model		
	R3	EN60730-1: 250 V~ 5(1) A; 100,000 operating cycles UL 873: 250 V~ 1A res 1FLA 6LRA C300; 30,000 operating cycles	
	R2	EN60730-1: 250 V~ 8(4) A on N.O., 6(4) A on N.C., 2(2) A on N.O. and N.C.; 100,000 operating cycles UL 873: 250 V~ 12A res 5FLA 30LRA C300; 30000 operating cycles	
	R1	EN60730-1: 250 V~ 10 (10) A; 100,000 operating cycles UL 873: 250 V~ 12A res 12HP 72LRA; 30,000 operating cycles	
		insulation from very low voltage parts reinforced; 6 mm air, 8 mm surface; 3750 V insulation insulation between the relay outputs independent basic; 3 mm air, 4 mm surface; 1250 V insulation	
Connections	Type of connection	Cross-sections	Maximum current
	fixed screw 16A	for cables from 0.5 to 4.5 mm ²	16 A
	fixed screw	for cables from 0.5 to 2.5 mm ²	12 A
	plug-in for screw blocks	for cables from 0.5 to 2.5 mm ²	12 A
	The correct sizing of the power and connection cables between the instrument and the loads is the responsibility of the installer. Depending on the model the maximum current at the common terminals is 12A or 16A. In the max load and max operating temp. conditions, the cables used must be suitable for operation up to 105°C.		
Case	plastic = O, L, H dimensions: 34.4x76.2x79 mm, mounting depth: 70.5 mm		
Assembly	smooth, hard and indeformable panel: side fastening brackets, to be pressed in fully drilling template: dimensions 28.8±0.2 x 70.8±0.2 mm		
Display	digits: 3 digit LED		
	display: from -99 to 999 operating status: indicated with graphic icons on the display		
Keypad	4 silicone rubber buttons		
Infrared receiver	available depending on the model		
Clock with backup battery	available depending on the model		
Buzzer	available in all models		
Clock	Error at 25 °C:	± 10 ppm (±5.3 min/year)	
	Error in the temperature range -10T60 °C:	- 50 ppm (-27min/year)	
	Ageing:	< ± 5 ppm (±2.7 min/year)	
	Discharge time:	typically 6 months (8 months maximum)	
	Recharge time:	typically 5 hours (< 8 hours maximum)	

Operating conditions	-10T60 °C; <90% RH non-condensing
Storage conditions	-20T70 °C; <90% RH non-condensing
Front panel index of protection	assembly on smooth and indeformable panel with IP65 gasket
Environmental pollution	2, normal situation
PTI of insulating materials	printed circuits 250, plastic and insulating materials 175
Period of stress across the insulating parts	long
Category of resistance to fire	category D and category B (UL 94-V0)
Class of protection against voltage surges	category II
Type of action and disconnection	1B relay contacts (micro-disconnection)
Construction of the control device	electronic control device incorporated
Classification according to protection against electric shock	class II when appropriately integrated
Device designed to be hand-held or integrated into equipment designed to be hand-held	no
Software class and structure	class A
Cleaning the front panel of the instrument	only use neutral detergents and water
Serial interface for CAREL network	External, available in all models
Interface for repeater display	External, available in models with power supplies H, L and 0
Maximum distance between interface and display	10 m
Programming key	Available in all models

Table 5.a

The IR33 Power range fitted with the standard Carel NTC probe is compliant with standard EN 13485 on thermometers for measuring the air temperature in applications on units for the conservation and sale of refrigerated, frozen and deep-frozen food and ice cream. Designation of the instrument: EN13485, air, S, A, 1, -50T90°C. The standard Carel NTC probe is identifiable by the printed laser code on "WP" models, or the code "103AT-11" on "HP" models, both visible on the sensor part.

Modello S senza ausiliario

IR33S*(A,E) (H,I,E,F) (A,B,C,D)*

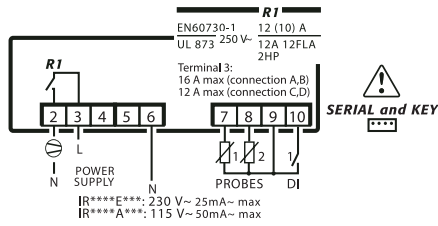

Modello S con ausiliario

IR33S*(A,E) (G,O,K,W) (E,F,G,H)*

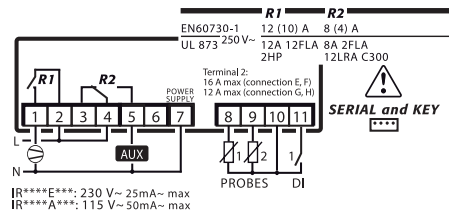

Modello S con ausiliario

IR33S*(A,E) (G,O,K,W) (E,F,G,H)*

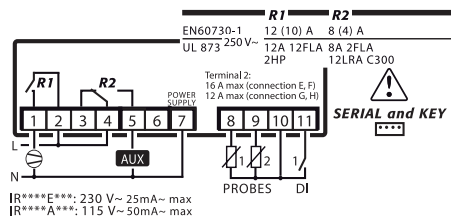

Modello F senza ausiliario

IR33F*(A,E) (H,I,E,F) (E,F,G,H)*

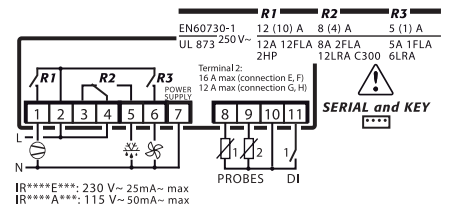

Modello Y senza ausiliario

IR33Y*(A,E) (H,I,E,F) (A,B,C,D)*

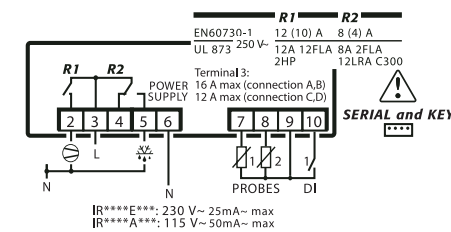

Modello Y senza ausiliario

IR33Y*(A,E) (H,I,E,F) (E,F,G,H)*

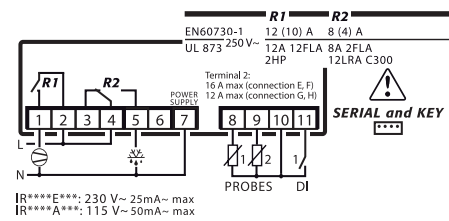

Modello Y con ausiliario

IR33Y*(A,E) (G,O,K,W) (E,F,G,H)*

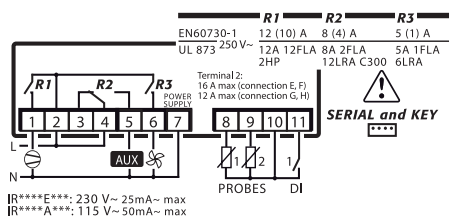

Modello Y con ausiliario

IR33Y*(A,E) (G,O,K,W) (E,F,G,H)*

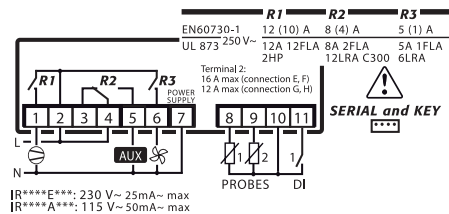

Modello F senza ausiliario

IR33F*(A,E) (H,I,E,F) (A,B,C,D)*

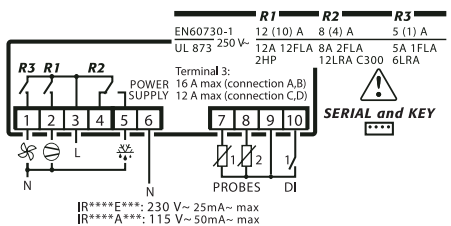

Fig. 5.a

6. IR33DIN

6.1 Dimensions

The dimensions of the ir33DIN are 60x111x70.4 mm for all versions, with the drilling template measuring 40x70 mm.

DIN rail assembly

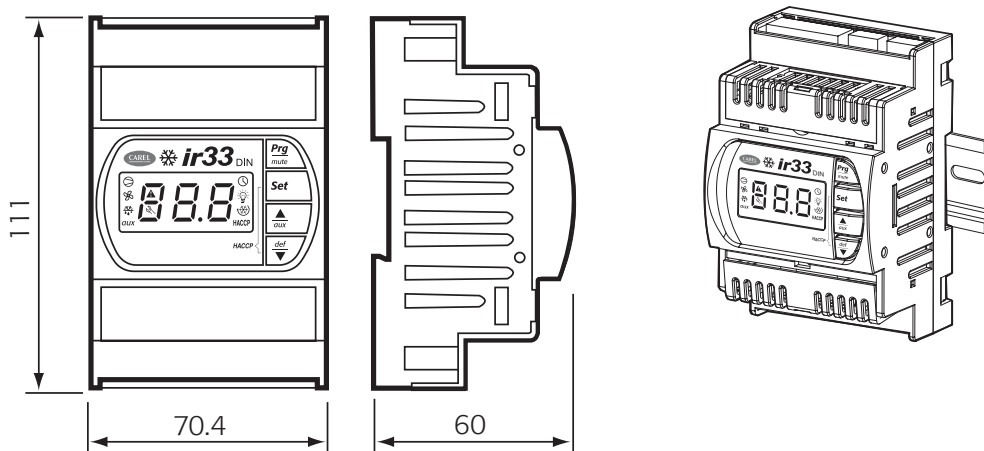

Fig. 6.a

6.2 Electrical specifications

Power supply	model E:	voltage 230 V~ 50/60 Hz;	power 3 VA, 25 mA~ max	
	model A:	115 V~ 50/60 Hz;	3 VA, 50 mA~ max	
	model H:	115-230 V~ 50/60 Hz;	6 VA, 50 mA~ max	
	model L:	12...24 V~ 50/60 Hz; 12 Vdc, 12 - 30 Vdc	4 VA, 300 mA~ max TRADR4W012 transformer, 315 mA slow-blow fuse in secondary, only use SELV power supply	
	model O:	12 V~ 50/60 Hz; 12 Vdc, 12 - 18 Vdc	4 VA, 300 mA~ max TRADR4W012 transformer, 315 mA slow-blow fuse in secondary, only use SELV power supply	
Insulation guaranteed by the power supply	model E, A, H:	voltage insulation from very low voltage parts: insulation from relay outputs:	power reinforced; 6 mm air, 8 mm surface; 3750 V insulation basic; 3 mm air, 4 mm surface; 1250 V insulation	
	model O, L:	insulation from very low voltage parts: insulation from relay outputs:	to be guaranteed externally by safety transformer basic; 6 mm air, 8 mm surface; 3750 V insulation	
Inputs	S1	NTC or PTC, depending on the model		
	S2	NTC or PTC, depending on the model		
	DI1	voltage-free contact, contact resistance < 10 ohm, closing current 6 mA		
	S3	NTC or PTC, depending on the model		
	DI2	voltage-free contact, contact resistance < 10 ohm, closing current 6 mA		
	S4	NTC or PTC, depending on the model		
	DI3	voltage-free contact, contact resistance < 10 ohm, closing current 6 mA		
	S5	NTC or PTC, depending on the model		
	Maximum distance between probes and digital inputs less than 10 m			
	Note: in the installation, keep the power supply and load connections separate from the probe, digital inputs, repeater display and supervisor cables.			
Type of probe	Std. Carel NTC	10 kΩ at 25 °C, range -50 to 90 °C measurement error: 1 °C in the range -50 to 50 °C 3 °C in the range +50 to 90 °C		
	High temperature NTC	50 kΩ at 25 °C, range -40 to 150 °C measurement error: 1.5 °C in the range -20 to 115 °C 4 °C in the range outside of -20 to 115 °C		
	Std. Carel PTC (specific model)	985 Ω at 25 °C, range -50 to 150 °C measurement error: 2 °C in the range -50 to 50 °C 4 °C in the range +50 to 150 °C		
Relay outputs	depending on the model			
	8 A	EN60730-1: 250 V~ 8(4) A on N.O., 6(4) A on N.C., 2(2) A on N.O. and N.C.; UL 873: 250 V~ 8A res 2FLA 12LRA C300;	100,000 operating cycles 30,000 operating cycles	
	16 A	EN60730-1: 250 V~ 10(4) on up to 60 °C on N.O., 12(2) A on N.O. and N.C.; UL 873: 250 V~ 12A res 5FLA 30LRA C300;	100,000 operating cycles 30,000 operating cycles	
	2HP	EN60730-1: 250 V~ 10 (10) A; UL 873: 250 V~ 12A res 12FLA 72LRA;	100,000 operating cycles 30,000 operating cycles	
	insulation from very low voltage parts		reinforced; 6 mm air, 8 mm surface; 3750 V insulation	
	insulation between the separate relay outputs		basic; 3 mm air, 4 mm surface; 1250 V insulation	

Connections	Type of connection	Cross-sections	Maximum current
	fixed screw 16A	for cables from 0.5 to 2.5 mm ²	12 A
	plug-in for screw blocks	for cables from 0.5 to 2.5 mm ²	12 A
	spade with crimped contact	for cables from 0.5 to 2.5 mm ²	12 A
	Wire cross-section for probes and digital inputs	0.5 to 2.5 mm ² (from 20 to 13 AWG)	
	Wire cross-section for power supply and loads	1.5 to 2.5 mm ² (from 15 to 13 AWG)	
	The correct sizing of the power and connection cables between the instrument and the loads is the responsibility of the installer. In the max load and max operating temp. conditions, the cables used must be suitable for operation up to 105°C.		
Case	plastic	dimensions: 111x70.4x60 mm	
Assembly	DIN rail:	using built-in fastening system	
	drilling template for front panel:	dimensions 45x70mm	
Display	digits: 3 digit LED		
	display: from -99 to 999		
	operating status: indicated with graphic icons on the display		
Keypad	4 silicone rubber buttons		
Infrared receiver	available depending on the model		
Clock with backup battery	available depending on the model		
Buzzer	available in all models		
Clock	Error at 25 °C:	± 10 ppm (±5.3 min/year)	
	Error in the temperature range -10T60 °C:	- 50 ppm (-27min/year)	
	Ageing:	< ± 5 ppm (±2.7 min/year)	
	Discharge time:	typically 6 months (8 months maximum)	
	Recharge time:	typically 5 hours (< 8 hours maximum)	
Operating conditions	power supply O, L, H: -10T55 °C; <90% RH non-condensing		
	power supply E, A: -10T50 °C; <90% RH non-condensing		
Storage conditions	-20T70 °C; <90% RH non-condensing		
Front panel index of protection	front panel IP40, complete controller IP20		
Environmental pollution	2, normal situation		
PTI of insulating materials	printed circuits 250, plastic and insulating materials 175		
Period of stress across the insulating parts	long		
Category of resistance to fire	category D and category B (UL 94-V0)		
Class of protection against voltage surges	category II		
Type of action and disconnection	1B relay contacts (micro-disconnection)		
Construction of the control device	electronic control device incorporated		
Classification according to protection against electric shock	class II when appropriately integrated		
Device designed to be hand-held or integrated into equipment designed to be hand-held	no		
Software class and structure	class A		
Cleaning the front panel of the instrument	only use neutral detergents and water		
Serial interface for CAREL network	Built-in, available in all models, upon request		
Interface for repeater display	Built-in, available in all models, upon request		
Maximum distance between interface and display	10 m		
Programming key	Available in all models		

Table 6.a

EN13485 certification

The ir33 platform range fitted with the standard Carel NTC probe is compliant with standard EN 13485 on thermometers for measuring the air temperature in applications on units for the conservation and sale of refrigerated, frozen and deep-frozen food and ice cream.

Designation of the instrument: EN13485, air, S, A, 1, -50 +90°C. The standard Carel NTC probe is identifiable by the printed laser code on "WP" models, or the code "103AT-11" on "HP" models, both visible on the sensor part.

6.3 Electrical connections

DN33(S-Y-F)*E(A-M-L-T)*0

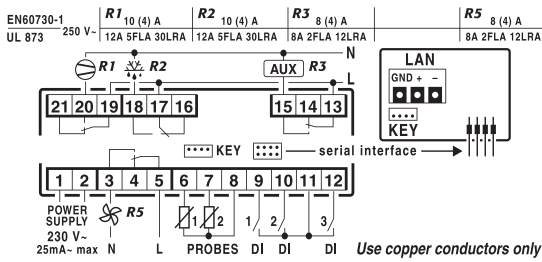

DN33(S-Y-F)*A(A-M-L-T)*0

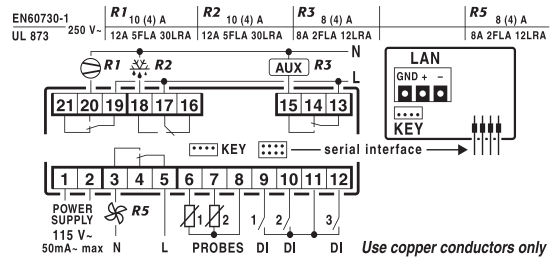

DN33(S-Y)*0(A-M-L-T)*0

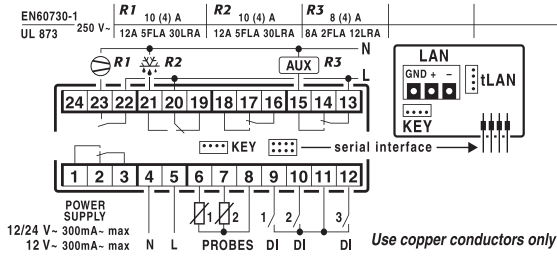

DN33(S-Y-F)*E(N-R-C-B)*0

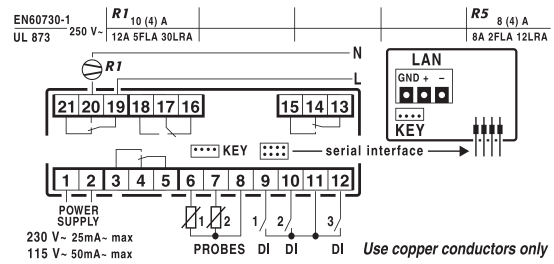

DN33(S-Y-F-C-H)*H(N-R-C-B)*0

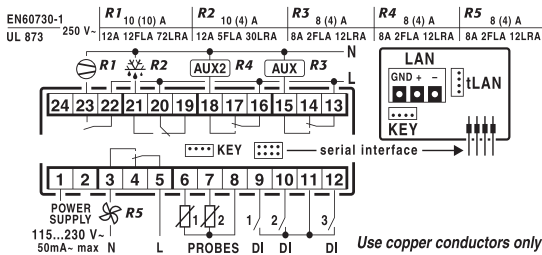

DN33(S-Y-F-C-H)*L(N-R-C-B)*0

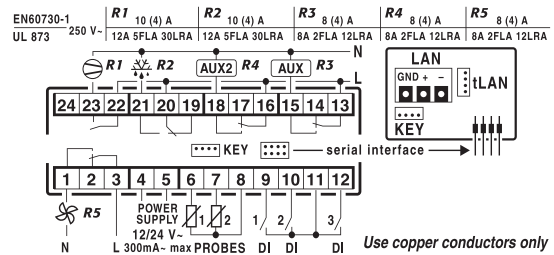

DN33(S-Y-F-C-H)*0(N-R-C-B)*0

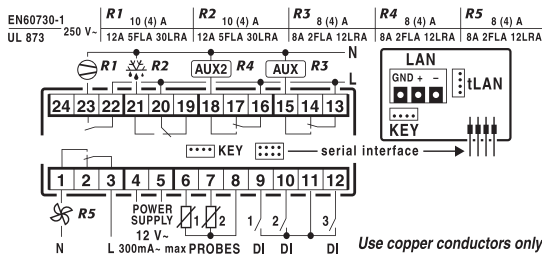

DN33(S-Y-F-C-H)*L(H-I-E-F)*0

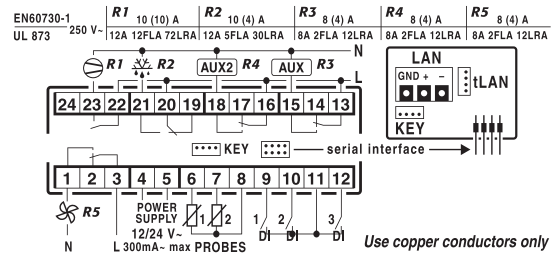

DN33(S-Y-F-C-H)*0(H-I-E-F)*0

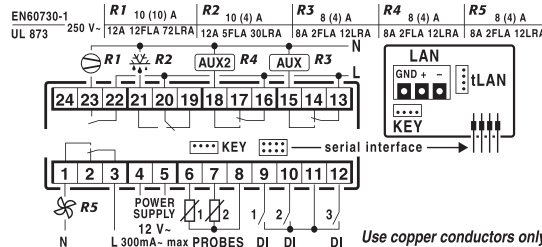

Fig. 6.b

CAREL

CAREL S.p.A.
Via dell'Industria, 11 - 35020 Brugine - Padova (Italy)
Tel. (+39) 049.9716611 - Fax (+39) 049.9716600
e-mail: carel@carel.com - www.carel.com

Agenzia / Agency: