

condensing  
**Units**

**R 134a**  
**R 404A/R 507**  
**R 22**

 **Embraco aspera**



## Index

	Page
1 - General	02
2 - Features and Benefits	02
3 - Technical Instructions / Installation Precautions	02
3.1 - General Information	02
3.2 - Basic Installation - Overview	02
3.3 - Installation Steps	02
3.4 - Cleaning the System	03
3.5 - Recommendations for Brazing (welding) the System	03
3.6 - Leakage Detection	03
3.7 - System Evacuation	03
3.8 - Procedures for Refrigerant Charge	03
3.9 - Piping	04
3.10 - Basic Accessories of a Cooling System	04
3.11 - Electrical Connections	05
Performances Tables	06
R 134a - LBP	06
R 404A / R 507 - LBP	06
R 22 - LBP	08
R 134a - HBP	08
R 22 - M/HBP	10
R 404A / R 507 - MBP	12
General Information	12
Available Accessories	14
R 134a - LBP	14
R 404A / R 507 - LBP	14
R 22 - LBP	14
R 134a - HBP	15
R 22 - M/HBP	15
R 404A / R 507 - MBP	16
External Views - With Accessories and Special Versions	16
External Views - Standard Versions	17
Wiring Diagrams	20
Rotalock Valves	23
Nomenclature	24

# Condensing Unit

## 1) - General

This catalog contains information on Embraco Condensing Units designed specifically for application in Europe.

The line of Embraco Condensing Units was designed in accordance with the strictest quality and reliability standards, available for a wide range of applications, varying from 1/7 HP to 2 HP in medium, low and high evaporating temperature applications, with R 22, R 134a, and R 404A / R 507.

### Your best choice in Condensing Units

Embraco Condensing Units are capable of addressing any need, starting from 1/7 HP. The units are based on dependable hermetic compressors, and are built in order to provide durability, high performance and low sound level.

Developed for use in a variety of cooling systems, Embraco Condensing Units are applied in undercounter refrigeration, liquid coolers, water cooling units, commercial freezers and refrigerators, walk-in coolers, ice-makers, vending machines, ice-cream dispensers, display cases, etc.

## 2) - Features and Benefits

### All Units

- Complete line from 1/7 to 2 HP
- Units available for R 134a, R 22, R 404A / R 507
- 100% factory tested
- Reliable, quiet and efficient hermetic compressors
- Corrosion resistant materials
- Oversized aluminum fin, copper tube condenser, capable of operating under high ambient temperatures and pressures
- UL approved for 60Hz version
- Customizable design (external casing, accessories)
- Low maintenance
- ROHS free, PED 97/23/CE - clause 3 par. 3

## 3) - Technical Instructions / Installation Precautions

The instructions below are general guidelines, but they do contain the major points that shall be taken into account for proper and safe product installation, in order to assure the best performance and the equipment warranty.

**Caution: Refrigeration systems are pressurized circuits, and it is of utmost importance that the condensing units are removed and installed only by technically qualified persons, knowledgeable about the equipment and procedures employed.**

### 3.1) - General Information

Inspect the unit for any damage that may have occurred during shipping. If damage is present, report to the carrier immediately.

To prevent loss, check in the box for any loose bag accessories, which may not be attached to the unit.

Only store, transport or install the condensing units in the proper position (right side up).

**Warning: Make sure you have read and understand all procedures and caution messages before you execute any maintenance or installation tasks! It is imperative – for your own safety - that the testing devices used are functioning well and properly sized.**

### 3.2) - Basic Installation – Overview

The installation site shall be well ventilated, ensuring that there will be sufficient air flow behind the condenser (refer to figure 1).

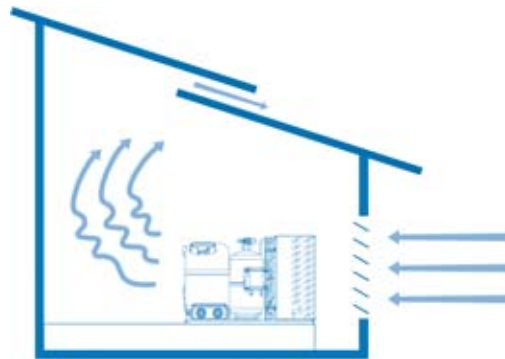

Figure 1 – Natural air flow through the roof

If the air flow to the condenser is restricted (even partly blocked), the performance of the system and reliability can be drastically reduced.

Embraco Condensing Units are designed to operate under room temperature up to 43°C (110°F). Therefore, make sure that the temperature at the installation site does not exceed the recommended limit.

**Attention: You must clean the condenser periodically, so that no particles will impair or block air circulation.**

### 3.3) - Installation Steps

- 3.3.1 - Select and size the equipment needed to assemble the refrigeration system, according to the project specifications (piping, valves, accessories, condenser unit). Carefully observe the application range for each model.
- 3.3.2 - Start by soldering the piping. After you have soldered the piping connections to the condensing unit and evaporator, perform the leak tests in all brazed or threaded joints.
- 3.3.3 - Evacuate the entire system (refer to item 3.7).
- 3.3.4 - Charge the refrigerant, preferably in liquid form, according to the required cooling gas mass (kg). (Refer to item 3.8).
- 3.3.5 - Switch the condensing unit on and access the system, monitoring the low and high pressures, temperature of the suction and liquid lines. Complete the cooler load if necessary.

3.3.6 - When the temperature inside the cooling system (chamber, conditioned environment) approaches the project value, proceed with the final adjustments, setting the system for continuous operation at full load.

3.3.7 - The superheating at the evaporator (given by the difference between temperatures at the piping surface at the point where the expansion valve's bulb is fixed, and the evaporation temperature\*) shall be between 5°C and 10°C (9°F and 18°F). Superheating at the compressor's inlet must be between 10°C and 15°C (18°F and 27°F) for this case, the difference between the temperature at the surface of the return pipe, at a distance 150 mm (6") from the compressor, and the evaporation temperature. The sub-cooling in the condenser shall be between 3°C and 10°C (5°F and 18°F), i.e., the condensing temperature less the temperature at the pipe's surface at the condenser's outlet.

\* Evaporation temperature obtained by converting the suction pressure into temperature.

### 3.4) - Cleaning the System

Cleaning the system before installing a new condensing unit is mandatory to completely remove residues and other contaminants.

The cleaning procedure for an installation process may be carried out by flushing the system with R 141b. Embraco recommends the installation of a filter-dryer at the suction line during the cleaner operation to retain and filter any undesired particles.

### 3.5) - Recommendations for Brazing (welding) the System

Circulate nitrogen (N<sub>2</sub>) through the pipes, with an internal pressure from 1 to 2 psig, to prevent oxidation and to avoid scales from forming, ensuring that the piping is free from any contaminants (oil, grease, oxides).

Use a damp cloth when welding the valves, fittings and pipes, to prevent overheating the components through heat propagation.

The compressor and the filter-dryer are extremely susceptible to humidity. As such, they shall only be opened during installation, leaving them exposed to air for a maximum of 10 minutes to open air.

### 3.6) - Leakage Detection

During the system leakage tests, never pressurize the pipes using air, oxygen or acetylene. There is a potential risk of fire and/or explosion.

After the installation is finished, pressurize the system to 100 psig (never use pressures higher than 150 psig, so as not to damage the low pressure switch), using nitrogen and/or a small refrigerant charge.

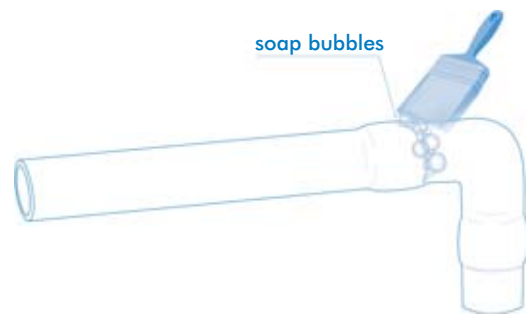

Figure 2 – Leakage tests with soap bubbles

Check for leaks using an electronic detector or a halide detector (torch). An alternative method is to check leakage with soap bubbles. When all fittings are properly installed, depressurize the system and go to the next step.

### 3.7) - System Evacuation

**Warning: Never use the compressor itself to evacuate the system, nor energize the system when it is under vacuum, as it may cause the compressor to short-circuit.**

To evacuate the system, use a high vacuum pump and a vacuum gage. The system shall be evacuated up to 200(μ) Hg or less. In any case, at least 20 minutes of vacuum must be applied.

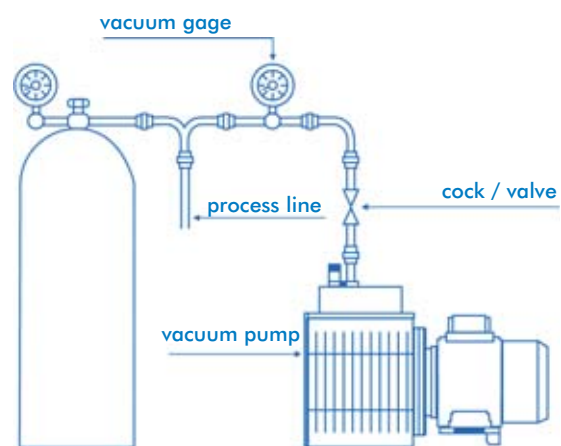

Figure 3 – High Vacuum Pump to evacuate the system

**Warning: Never use anti-freeze elements (methyl alcohol and derivatives), as they cause irreversible damages to the cooling system.**

### 3.8) - Procedures for Refrigerant Charge

The refrigerant shall only be charged after the proper vacuum has been achieved. Please check on the compressor or condensing unit tag what is the type of refrigerant that should be used to charge the system. Break the vacuum only when the compressor is switched off.

It is recommended that the refrigerant charge be provided in the liquid state (with the compressor switched off), through the high side (tank liquid valve) and by the refrigerant mass measurement (lb), according to the system specification.

# Condensing Unit

Wait for 15 minutes before switching on the system again, so as to allow the gas to be evenly distributed and balance the pressure levels.

The fine tuning of the refrigerant charge must be done while the system is running (compressor switched on), by observing the sight glass. The charge will be complete when there are no more bubbles forming.

When performing a condensing unit replacement always check the specified refrigerant charge.

## 3.9) - Piping

Piping shall be sized so that:

- 3.9.1 - It is flexible, so as to avoid rupture due to expansion and due to the transmission of vibration usually caused by compressors.
- 3.9.2 - Ensure that the refrigerant is well distributed through the evaporator(s), and prevent the liquid from flowing back to the compressor. To do that, use an expansion valve with proper dimensions, and an inverted siphon at the outlet of each evaporator.

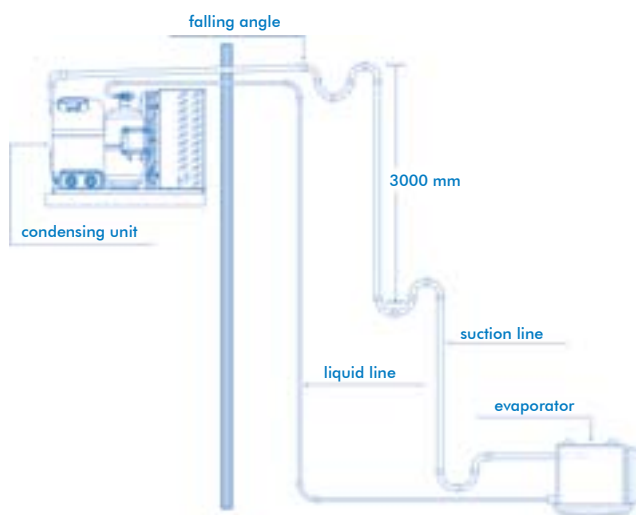

Figure 4 – Evaporator under the condensing unit

- 3.9.3 - Prevent the liquid from flowing back to the compressor when the system stops and the evaporator(s) is/are located above the Condensing Unit, using an inverted siphon and suction accumulator.
- 3.9.4 - Aid the return of lubricating oil coming from the evaporator(s) to the system where the Condensing Unit is located over 3000 mm above the evaporator(s), using an inverted siphon every 3000 mm in the piping.
- 3.9.5 - Allow secondary operations, such as attaching measurement instruments, isolating stretches for maintenance purposes and pump down.

**Warning: The diameter of the fittings for the condensing units and evaporators shall not be used as a parameter to select the diameters of the other system components.**

**Attention: After replacement the condensing unit and its accessories must be handled and recycled according to the material group (ferrous, non-ferrous, polymers, oils, ...) directives. These recommendations are intended to minimize the adverse impacts on the environment.**

## 3.10) - Basic Accessories of a Cooling System

### 3.10.1 - Filter-Dryer

Installed at the liquid line, its function is to retain particles and mainly remove residual humidity from the system.



### 3.10.2 - Sight Glass

It is installed at the liquid line, just after the filter-dryer and used to monitor the system refrigerant charge. Some models also allow humidity detection.



### 3.10.3 - Pressure Control

Some of Embraco Condensing Units are fitted with High / Low Pressure Switches. Their function is to prevent the compressor from operating under pressure levels that are outside of their application range.



### 3.10.4 - Solenoid Valve

It is installed at the liquid line, prior to the expansion valve and used for the pump down procedure.



### 3.10.5 - Oil Separator

It is installed at the discharge line, when the evaporator is below the compressor's height (long distances).



### 3.10.6 - Suction Accumulator

It is installed at the suction line, just before the compressor. It prevents liquid refrigerant from flowing back towards the compressor.



Conditions that favor the flow-back of liquid to the compressor and where the use of a suction accumulator is recommended:

- Systems with more than one evaporator
- High refrigerant charges
- Operations with defrosting by hot gas
- Where the distance from the compressor to the evaporator is over 15 meters (50 feet)
- Evaporator(s) above the condensing unit

### 3.10.7 - Fan Speed Control

The Fan Speed Control controls the head pressure in air-cooled condensers by reducing the fan speed to maintain head pressure as the outside temperatures/condenser pressure drops. As the motor speed drops under lower ambient/load condition fan noise is also reduced.



### 3.10.8 - Schrader Valve

Used for service operation (Refrigerant Charge).



### 3.10.9 - CU Housing

For external use, to protect the condensing unit from corrosion.



### 3.10.10 - Expansion Valve

It is installed at the liquid line, prior to the evaporator. Its function is to maintain pressure difference between the condenser and the evaporator, and to adjust the refrigerant flow into the evaporator. For systems operating under low evaporating temperatures (lower than  $-17.7^{\circ}\text{C}$  ( $0^{\circ}\text{F}$ )), we recommend using an expansion valve fitted with MOP (Maximum Operation Pressure), to protect the compressor against high pressures in suction during the start procedure.

### 3.10.11 - Suction Filter

It is recommended to clean the systems if the compressor has burned out. Installed at the suction line, its main task is to retain the contaminants (result of the burning of the compressor), and to retain system particles.

## 3.11 - Electrical Connections

Check the electrical rating printed on the unit name plate, and make sure it corresponds to the power supply being used.

Check the electrical rating on the fan motor, and make sure it corresponds to the power supply being used.

**Warnings: Do not remove the compressor terminal cover while the compressor is running – electrocution may occur.**

**Do not operate the unit unless it is grounded – electrocution may occur.**

**Respect local electrical safety regulations.**

# R 134a - LBP

MODEL	B.O.M.	ELECTRICAL VERSION	MOTOR TYPE	VERSION *			EXPANSIVE DEVICE	HP	PERFORMANCE / EVAPORATING TEMPERATURE °C **								APPLICATION RANGE IN 43°C	RECEIVER VOLUME litre	VALVES TUBE LINE O.D.		
				V-2	V-3	V-9			-30	-25	RATED -23.3			-20	-15	-10			-5	SUCTION inch	LIQUID inch
											W	W	W								
UNB1112Z	583FG	G	RSIR	ok	ok	-	C	1/5-	109	145	160	178	2.4	191	245	306	373	-30 to -5	-	3/8	1/4
UNB1112Z	583FA	A	RSIR	ok	ok	-	C	1/6	92	144	142	127	0.9	170	218	266	325	-30 to -5	-	3/8	1/4
UNB1116Z	584SA	A	RSIR	ok	ok	-	C	1/5	136	178	203	182	1.4	233	293	365	436	-30 to -5	-	3/8	1/4
UNB2116Z	584TA	A	CSIR	ok	ok	ok	C-V	1/5	136	178	203	182	1.4	233	293	365	436	-30 to -5	0.6	3/8	1/4
UNB2116Z	584TG	G	CSIR	ok	ok	-	C-V	1/4	159	208	229	211	3.1	272	427	459	510	-30 to -5	0.5	3/8	1/4
UNB1118Z	584UA	A	RSIR	ok	ok	-	C	1/4+	171	222	244	185	1.3	291	372	463	560	-30 to -5	-	3/8	1/4
UNB1118Z	584UG	G	RSIR	ok	ok	-	C	1/3	200	259	286	222	3.1	341	435	542	656	-30 to -5	-	3/8	1/4
UNB2118Z	584VA	A	CSIR	ok	ok	ok	C-V	1/4+	171	222	244	185	1.3	291	372	463	560	-30 to -5	0.6	3/8	1/4
UNE1121Z	572AA	A	RSIR	ok	ok	-	C	1/3	214	279	308	269	2.0	370	478	600	733	-30 to -5	-	3/8	1/4
UNE1121Z	572AG	G	RSIR	ok	ok	-	C	1/3+	250	327	360	296	4.4	436	559	702	857	-30 to -5	-	3/8	1/4
UNE2121Z	572BA	A	CSIR	ok	ok	ok	C-V	1/3	214	279	308	269	2.0	370	478	600	733	-30 to -5	0.6	3/8	1/4
UNE2121Z	572BG	G	CSIR	ok	ok	-	C-V	1/3+	250	327	360	296	4.4	433	559	702	857	-30 to -5	0.5	3/8	1/4
UNE1130Z	572CA	A	RSIR	ok	ok	-	C	1/3+	276	356	390	310	2.3	465	606	762	919	-30 to -5	-	3/8	1/4
UNE1130Z	572CG	G	RSIR	ok	ok	-	C	1/2	322	416	456	350	5.3	544	709	891	1074	-30 to -5	-	3/8	1/4
UNE2130Z	572DA	A	CSIR	ok	ok	ok	C-V	1/3+	276	356	390	310	2.3	465	606	762	919	-30 to -5	1.1	3/8	1/4
UNE2130Z	572DG	G	CSIR	ok	ok	-	C-V	1/2	322	416	456	350	5.3	544	709	891	1074	-30 to -5	1.0	3/8	1/4
UT2134Z	533BV	V	CSIR	ok	ok	ok	C-V	1/2	302	395	433	400	3.2	512	657	824	988	-30 to -5	0.6	3/8	1/4
UT2134Z	533BG	G	CSIR	ok	ok	-	C-V	1/2+	353	463	506	436	5.8	599	769	965	1157	-30 to -5	0.5	3/8	1/4
UT1140Z	537AA	A	RSIR	ok	ok	-	C	2/3	393	512	560	462	3.5	674	866	1093	1337	-30 to -5	-	3/8	1/4
UT2140Z	537BA	A	CSIR	ok	ok	ok	C-V	2/3	393	512	560	462	3.5	674	866	1093	1337	-30 to -5	1.1	3/8	1/4
UJ2152Z	564AA	A	CSR	ok	ok	ok	C-V	3/4-	453	593	657	540	3.6	797	1035	1302	1605	-30 to -5	1.3	1/2	3/8

Notes: \* Version: V-2 - with receiver, with two valves (flare or weld connection) | V-3 - capillary version - without valves, without receiver | V-9 - V2 + selected accessories.

# R 404A / R 507 - LBP

MODEL	B.O.M.	ELECTRICAL VERSION	MOTOR TYPE	VERSION *			EXPANSIVE DEVICE	HP	PERFORMANCE / EVAPORATING TEMPERATURE °C **								APPLICATION RANGE IN 43°C	RECEIVER VOLUME litre	VALVES TUBE LINE O.D.			
				V-2	V-3	V-9			-40	-35	-30	-25	RATED -23.3			-20			-15	-10	SUCTION inch	LIQUID inch
													W	W	W							
UNB2121GK	595BN	N	CSIR	ok	ok	ok	C-V	1/3	119	162	211	257	285	278	2.28	324	388	456	-40 to -10	0.6	3/8	1/4
UNE2125GK	671TA	A	CSIR	ok	ok	ok	C-V	1/2-	145	206	283	374	406	342	2.48	469	579	731	-40 to -10	1.1	3/8	1/4
UNE2125GK	671TD	D	CSIR	ok	ok	-	C-V	1/2	153	249	341	466	512	400	6.30	557	629	766	-40 to -10	1.0	3/8	1/4
UNE2125GK	671TG	G	CSIR	ok	ok	-	C-V	1/2	153	249	341	466	512	400	6.30	557	629	766	-40 to -10	1.0	3/8	1/4
UNEK2125GK	657EA	A	CSIR	ok	ok	ok	C-V	1/2-	194	236	322	368	410	342	2.50	451	529	644	-40 to -10	1.1	3/8	1/4
UNE2134GK	673TA	A	CSIR	ok	ok	ok	C-V	1/2+	149	234	337	456	502	470	3.80	593	733	884	-40 to -10	1.1	3/8	1/4
UNE2134GK	673TD	D	CSIR	ok	ok	-	C-V	2/3	174	273	394	534	587	545	7.10	694	857	1034	-40 to -10	1.0	3/8	1/4
UNE2134GK	673TG	G	CSIR	ok	ok	-	C-V	2/3	174	273	394	534	587	545	7.10	694	857	1034	-40 to -10	1.0	3/8	1/4
UNEK2134GK	558AA	A	CSIR	ok	ok	ok	C-V	1/2+	227	267	381	474	490	342	2.50	552	649	756	-40 to -10	1.1	3/8	1/4
UNEK2150GK	559AA	A	CSIR	ok	ok	ok	C-V	2/3+	341	398	474	569	639	530	3.41	683	817	969	-40 to -10	1.1	3/8	1/4
UNEK2168GK	559FA	A	CSR/CSIR	ok	ok	ok	C-V	1+	330	453	585	760	840	730	8.70	957	1120	1270	-40 to -10	1.1	3/8	1/4
UT2155GK	636CA	A	CSR	ok	ok	ok	C-V	3/4	237	340	462	600	656	520	2.60	765	942	1123	-40 to -10	1.2	3/8	1/4
UT2155GK-	636DG	G	CSIR	ok	ok	-	C-V	3/4	251	343	481	669	667	609	7.80	905	1078	1369	-40 to -10	1.3	3/8	1/4
UT2168GK	636JA	A	CSR	ok	ok	ok	C-V	1-	333	453	595	763	832	655	2.92	940	1142	1372	-40 to -10	1.2	3/8	1/4
UT2168GK	636JG	G	CSR	ok	ok	-	C-V	1	346	476	615	800	883	769	9.20	1007	1179	1337	-40 to -10	1.0	3/8	1/4
UT2178GK	636QA	A	CSR	ok	ok	ok	C-V	1 1/6	437	586	753	947	1038	770	4.36	1165	1410	1693	-40 to -10	1.2	3/8	1/4
UT2178GK	636QG	G	CSR	ok	ok	-	C-V	1 1/5	437	604	783	970	1038	852	4.36	1171	1381	1603	-40 to -10	1.0	3/8	1/4
UT2178GK	636QD	D	RSIR	ok	ok	-	C-V	1 1/5	437	604	783	970	1038	852	4.36	1171	1381	1603	-40 to -10	1.0	3/8	1/4
UT2180GK	636XA	A	CSR	ok	ok	ok	C-V	1 1/4	450	610	790	1000	1110	841	3.50	1240	1508	1873	-40 to -10	1.2	3/8	1/4
UT2180GK	636XD	D	CSR	ok	ok	ok	C-V	1 1/4	450	610	790	1000	1110	841	3.50	1240	1508	1873	-40 to -10	1.1	3/8	1/4
UT2180GK	636XG	G	CSR	ok	ok	ok	C-V	1 1/4	450	610	790	1000	1110	841	3.50	1240	1508	1873	-40 to -10	1.1	3/8	1/4
UNT2192GK	553EA	A	CSR/CSIR	ok	ok	ok	C-V	1 1/2	452	610	801	1024	1100	862	5.40	1279	1568	1885	-40 to -11	2.3	1/2	3/8
U(N)J2192GK	664SA (644AA)	A	CSR	ok	ok	ok	C-V	1 1/2-	453	612	795	1087	1198	942	4.31	1373	1687	2030	-40 to -10	2.3	1/2	3/8
U(N)J2192GK	664SD (644AD)	D	CSR	ok	ok	-	C-V	1 1/2-	530	715	930	1170	1265	1175	7.00	1442	1742	2067	-40 to -10	2.3	1/2	3/8
U(N)J2192GS	668SM (648AM)	M	3 Ph	ok	ok	ok	C-V	1 1/5	453	612	795	1000	1081	900	2.10	1233	1488	1767	-40 to -10	2.3	1/2	3/8
U(N)J2212GK	663TA (643TA)	A	CSR	ok	ok	ok	C-V	1 3/4	616	886	1163	1479	1599	1175	6.10	1826	2198	2605	-40 to -10	2.3	5/8	3/8
U(N)J2212GK	663TA (643TA)	A	CSR	ok	ok	ok	C-V	1 3/4	616	886	1163	1479	1599	1175	6.20	1826	2198	2605	-40 to -10	2.3	5/8	3/8
U(N)J2212GK	663TD (643TD)	D	CSR	ok	ok	-	C-V	2	721	1037	1360	1730	1871	1370	7.10	2136	2571	3048	-40 to -10	2.3	5/8	3/8
U(N)J2212GK	663TD (643TD)	D	CSR	ok	ok	-	C-V	2	721	1037	1360	1730	1871	1370	7.70	2136	2571	3048	-40 to -10	2.3	5/8	3/8
U(N)J2212GS	667TM (647AM)	M	3 Ph	ok	ok	ok	C-V	1 3/4	616	886	1163	1479	1599	1479	2.30	1826	2198	2605	-40 to -10	2.3	5/8	3/8

Notes: \* Version: V-2 - with receiver, with two valves (flare or weld connection) | V-3 - capillary version - without valves, without receiver | V-9 - V2 + selected accessories.

	FAN			FAN MOTOR				WEIGHT (Only Reference) kg / lb	OVERALL DIMENSIONS				CONDENSER		MODEL
	O.D. mm / inch	No. & Angle of Blades	No. of Fans	Air Flow Rate	Rated Output	Rated Input	Rated Input		A	B	C	DRAWING NUMBER	No. OF ROWS	No. OF TUBES	
				m³(h)	W	W	A		mm / inch	mm / inch	mm / inch				
200 / 7.87	5/28°	1	240	9	34	0.45	12.6 / 27.8	415 / 16.33	290 / 11.42	226 / 8.90	1955183	1	8	UNB1112Z	
200 / 7.87	5/28°	1	240	10	36	0.25	12.6 / 27.8	480 / 18.90	300 / 11.81	226 / 8.90	1955191	1	8	UNB1112Z	
200 / 7.87	5/28°	1	240	10	36	0.25	14.9 / 32.9	415 / 16.33	290 / 11.42	226 / 8.90	1955183	2	8	UNB1116Z	
200 / 7.87	5/28°	1	240	10	36	0.25	14.9 / 32.9	480 / 18.90	300 / 11.81	226 / 8.90	1955191	2	8	UNB1116Z	
200 / 7.87	5/28°	1	240	10	38	0.25	15.2 / 33.5	430 / 16.90	290 / 11.42	226 / 8.90	1955183	2	8	UNB2116Z	
200 / 7.87	5/28°	1	240	10	38	0.25	15.2 / 33.5	480 / 18.90	300 / 11.81	226 / 8.90	1955191	2	8	UNB2116Z	
200 / 7.87	5/28°	1	280	9	34	0.45	15.3 / 33.7	430 / 16.90	306 / 12.05	226 / 8.90	1955183	2	8	UNB1118Z	
200 / 7.87	5/28°	1	280	9	34	0.45	15.3 / 33.7	480 / 18.90	306 / 12.05	226 / 8.90	1955183	2	8	UNB1118Z	
200 / 7.87	5/28°	1	240	10	38	0.25	15.7 / 34.6	430 / 16.90	290 / 11.42	226 / 8.90	1955183	2	8	UNB2118Z	
200 / 7.87	5/28°	1	240	10	38	0.25	15.7 / 34.6	480 / 18.90	300 / 11.81	226 / 8.90	1955191	2	8	UNB2118Z	
200 / 7.87	5/28°	1	245	10	38	0.25	16.4 / 36.2	430 / 16.90	306 / 12.05	226 / 8.90	1955183	3	8	UNE1121Z	
200 / 7.87	5/28°	1	275	9	34	0.45	16.4 / 36.2	480 / 18.90	300 / 11.81	226 / 8.90	1955191	3	8	UNE1121Z	
200 / 7.87	5/28°	1	245	10	38	0.25	16.4 / 36.2	430 / 16.90	306 / 12.05	226 / 8.90	1955183	3	8	UNE2121Z	
200 / 7.87	5/28°	1	275	9	34	0.45	16.4 / 36.2	480 / 18.90	306 / 12.05	226 / 8.90	1955183	3	8	UNE2121Z	
200 / 7.87	5/28°	1	275	9	34	0.45	16.6 / 36.6	430 / 16.90	306 / 12.05	226 / 8.90	1955183	3	8	UNE2121Z	
230 / 9.06	5/28°	1	310	10	38	0.25	17.0 / 37.5	480 / 18.90	300 / 11.81	254 / 10.00	1955191	3	9	UNE1130Z	
230 / 9.06	5/28°	1	310	10	38	0.25	17.0 / 37.5	435 / 17.10	290 / 11.42	254 / 10.00	1955183	3	9	UNE1130Z	
230 / 9.06	5/28°	1	310	10	38	0.25	17.5 / 38.6	480 / 18.90	300 / 11.81	254 / 10.00	1955191	3	9	UNE2130Z	
230 / 9.06	5/28°	1	310	10	38	0.25	17.5 / 38.6	435 / 17.13	306 / 12.05	254 / 10.00	1955183	3	9	UNE2130Z	
230 / 9.06	5/28°	1	310	10	38	0.25	20.7 / 45.6	443 / 17.44	310 / 12.20	254 / 10.00	1955192	3	9	UT2134Z	
230 / 9.06	5/28°	1	355	9	34	0.45	20.7 / 45.6	443 / 17.44	310 / 12.20	254 / 10.00	1955192	3	9	UT2134Z	
254 / 10.00	5/28°	1	580	16	60	0.42	23.6 / 52.0	465 / 18.31	340 / 13.39	296 / 11.65	1955185	3	11	UT1140Z	
254 / 10.00	5/28°	1	580	16	60	0.42	23.6 / 52.0	465 / 18.31	340 / 13.39	296 / 11.65	1955185	3	11	UT2140Z	
254 / 10.00	5/28°	1	580	16	60	0.42	35.8 / 78.9	465 / 18.31	340 / 13.39	296 / 11.65	1955196	4	11	UJ2152Z	

\*\* Test Conditions: Ambient 32°C (90°F) | Max. subcooling 3°C (5°F) | Evaporator outlet and gas return 32°C (90°F).  
For electrical version D and G, version V-9 on request.

	FAN			FAN MOTOR				WEIGHT (Only Reference) kg / lb	OVERALL DIMENSIONS				CONDENSER		MODEL
	O.D. mm / inch	No. & Angle of Blades	No. of Fans	Air Flow Rate	Rated Output	Rated Input	Rated Input		A	B	C	DRAWING NUMBER	No. OF ROWS	No. OF TUBES	
				m³(h)	W	W	A		mm / inch	mm / inch	mm / inch				
200 / 7.87	5/28°	1	240	10	36	0.25	17.4 / 38.4	480 / 18.90	300 / 11.81	226 / 8.90	1955191	3	8	UNB2121GK	
230 / 9.06	5/28°	1	340	10	36	0.25	17.7 / 39.0	430 / 16.90	306 / 12.05	226 / 8.90	1955183	3	9	UNE2125GK	
230 / 9.06	5/28°	1	370	9	34	0.45	17.9 / 39.5	480 / 18.90	300 / 11.81	254 / 10.00	1955191	3	9	UNE2125GK	
230 / 9.06	5/28°	1	370	9	34	0.45	17.9 / 39.5	435 / 17.13	306 / 12.05	254 / 10.00	1955183	3	9	UNE2125GK	
230 / 9.06	5/28°	1	340	10	36	0.25	17.9 / 39.5	435 / 17.13	306 / 12.05	254 / 10.00	1955183	3	9	UNEK2125GK	
254 / 10.00	5/28°	1	320	16	60	0.42	20.0 / 44.1	465 / 18.31	340 / 13.39	296 / 11.65	1955184	3	11	UNE2134GK	
254 / 10.00	5/28°	1	370	16	58	0.36	20.0 / 44.1	465 / 18.31	340 / 13.39	296 / 11.65	1955184	3	11	UNE2134GK	
254 / 10.00	5/28°	1	370	16	58	0.74	20.0 / 44.1	465 / 18.31	340 / 13.39	296 / 11.65	1955184	3	11	UNE2134GK	
254 / 10.00	5/28°	1	320	16	60	0.42	20.0 / 44.1	465 / 18.31	340 / 13.39	296 / 11.65	1955184	3	11	UNEK2134GK	
254 / 10.00	5/28°	1	320	16	60	0.42	20.0 / 44.1	465 / 18.31	340 / 13.39	296 / 11.65	1955184	3	11	UNEK2150GK	
254 / 10.00	5/28°	1	320	16	60	0.42	23.8 / 53.0	465 / 18.31	340 / 13.39	296 / 11.65	1955184	3	11	UNEK2168GK	
254 / 10.00	5/28°	1	580	16	60	0.42	27.0 / 59.5	465 / 18.31	340 / 13.39	296 / 11.65	1955193	4	11	UT2155GK	
254 / 10.00	5/28°	1	670	16	58	0.74	27.0 / 59.5	465 / 18.31	340 / 13.39	296 / 11.65	1955193	4	11	UT2155GK-	
254 / 10.00	5/28°	1	580	16	60	0.42	28.5 / 62.8	465 / 18.31	340 / 13.39	296 / 11.65	1955193	4	11	UT2168GK	
254 / 10.00	5/28°	1	670	16	58	0.74	28.5 / 62.8	465 / 18.31	340 / 13.39	296 / 11.65	1955193	4	11	UT2168GK	
254 / 10.00	5/28°	1	580	16	60	0.42	28.5 / 62.8	465 / 18.31	340 / 13.39	296 / 11.65	1955193	4	11	UT2178GK	
254 / 10.00	5/28°	1	670	16	58	0.74	28.5 / 62.8	465 / 18.31	340 / 13.39	296 / 11.65	1955193	4	11	UT2178GK	
254 / 10.00	5/28°	1	580	16	60	0.42	28.5 / 62.8	465 / 18.31	340 / 13.39	296 / 11.65	1955193	4	11	UT2180GK	
254 / 10.00	5/28°	1	670	16	60	0.36	29.0 / 63.9	465 / 18.31	340 / 13.39	296 / 11.65	1955193	4	11	UT2180GK	
254 / 10.00	5/28°	1	670	16	58	0.74	29.0 / 63.9	465 / 18.31	340 / 13.39	296 / 11.65	1955193	4	11	UT2180GK	
275 / 10.83	5/31°	1	600	34	110	0.75	36.2 / 79.8	518 / 20.39	395 / 15.55	324 / 12.76	1955194	3	12	UNT2192GK	
275 / 10.83	5/31°	1	600	34	110	0.75	36.2 / 79.8	477 / 18.78	410 / 16.14	324 / 12.76	1955186	3	12	U(N)J2192GK	
275 / 10.83	5/31°	1	980	25	60	0.55	36.2 / 79.8	477 / 18.78	410 / 16.14	324 / 12.76	1955186	3	12	U(N)J2192GK	
275 / 10.83	5/31°	1	850	34	100	0.38	36.2 / 79.8	477 / 18.78	410 / 16.14	324 / 12.76	1955186	3	12	U(N)J2192GS	
275 / 10.83	5/31°	1	800	34	110	0.75	37.0 / 81.5	477 / 18.78	410 / 16.14	324 / 12.76	1955186	4	12	U(N)J2212GK	
2x254/10.00	5/28°	2	1400	2x16	2x60	2x0.42	40.0 / 88.2	440 / 17.32	783 / 30.83	313 / 12.32	1955209	3	11	U(N)J2212GK	
275 / 10.83	5/31°	1	980	25	60	0.55	40.0 / 88.2	477 / 18.78	410 / 16.14	324 / 12.76	1955186	4	12	U(N)J2212GK	
2x254/10.00	5/28°	2	1400	2x16	2x60	2x0.42	40.0 / 88.2	440 / 17.32	783 / 30.83	313 / 12.32	1955209	3	11	U(N)J2212GK	
275 / 10.83	5/31°	1	850	34	100	0.38	40.0 / 88.2	477 / 18.78	410 / 16.14	324 / 12.76	1955186	4	12	U(N)J2212GS	

\*\* Test Conditions: Ambient 32°C (90°F) | Max. subcooling 3°C (5°F) | Evaporator outlet and gas return 32°C (90°F).  
For electrical version D and G, version V-9 on request.

# R 22 - LBP

MODEL	B.O.M.	ELECTRICAL VERSION	MOTOR TYPE	VERSION *			EXPANSIVE DEVICE	HP	PERFORMANCE / EVAPORATING TEMPERATURE °C - **									APPLICATION RANGE IN 43°C	RECEIVER VOLUME litre	VALVES TUBE LINE O.D.	
				V-2	V-3	V-9			-30	-25	RATED -23.3			-20	-15	-10	SUCTION inch			LIQUID inch	
											W	W	W								W <sub>inp</sub>
UNE2125E	671IA	A	CSIR	ok	ok	ok	C-V	1/3-	221	302	326	305	2.0	390	494	616	-30 to -10	1.1	3/8	1/4	
UNE2134E	673AA	A	CSIR	ok	ok	ok	C-V	1/2	314	407	442	413	2.7	512	634	767	-30 to -10	1.1	3/8	1/4	
UNE2134E	673AD	D	CSIR	ok	ok	-	C-V	1/2+	397	511	553	472	3.2	641	787	947	-30 to -10	1.1	3/8	1/4	
UT2140E	636AA	A	CSIR	ok	ok	ok	C-V	1/2+	401	500	541	552	3.7	628	767	930	-30 to -10	1.2	3/8	1/4	
UT2140E	636AD	D	CSIR	ok	ok	-	C-V	3/4	470	585	633	618	4.4	735	898	1088	-30 to -10	1.2	3/8	1/4	
UT2155E	636BA	A	CSR	ok	ok	ok	C-V	3/4	506	628	674	582	2.9	779	960	1198	-30 to -10	1.2	3/8	1/4	
UT2168E	636KA	A	CSR	ok	ok	ok	C-V	1-	616	767	826	652	3.2	965	1233	1529	-30 to -10	1.2	5/8	3/8	
UJ2178E	664GA	A	CSR	ok	ok	ok	C-V	1 1/5	779	965	1052	840	4.1	1221	1547	1942	-30 to -10	2.3	1/2	3/8	
U(N)J2190E	663NV (543NV)	V	CSR	ok	ok	ok	C-V	1 1/3	802	1186	1108	960	4.6	1387	1789	2132	-30 to -10	2.3	1/2	3/8	

Notes: \* Version: V-2 - with receiver, with two valves (flare or weld connection) | V-3 - capillary version - without valves, without receiver | V-9 - V2 + selected accessories.

# R 134a - HBP

MODEL	B.O.M.	ELECTRICAL VERSION	MOTOR TYPE	VERSION *			EXPANSIVE DEVICE	HP	PERFORMANCE / EVAPORATING TEMPERATURE °C - **										APPLICATION RANGE IN 43°C	RECEIVER VOLUME litre	VALVES TUBE LINE O.D.	
				V-2	V-3	V-9			-15	-10	-5	0	5	RATED 7.2			10	SUCTION inch			LIQUID inch	
														W	W <sub>inp</sub>	RLA						W
UNB5125Z	583AA	A	RSIR	ok	ok	-	C	1/7-	148	183	222	270	320	342	179	1.1	372	-15 to +10	-	3/8	1/4	
UNB5125Z	583AG	G	RSIR	ok	ok	-	C	1/7-	173	214	259	315	374	400	211	2.5	435	-15 to +10	-	3/8	1/4	
UNB5128Z	583BA	A	RSIR	ok	ok	-	C	1/7-	164	203	250	302	359	384	209	1.2	419	-15 to +10	-	3/8	1/4	
UNB5128Z	583BG	G	RSIR	ok	ok	-	C	1/7	192	238	293	353	421	449	244	2.9	490	-15 to +10	-	3/8	1/4	
UNB5132Z	583CA	A	RSIR	ok	ok	-	C	1/7	186	233	285	347	413	442	229	1.3	483	-15 to +10	-	3/8	1/4	
UNB5132Z	583CG	G	RSIR	ok	ok	-	C	1/6-	217	272	334	406	483	517	279	3.2	565	-15 to +10	-	3/8	1/4	
UNB5144Z	584AA	A	RSIR	ok	ok	-	C	1/6+	269	330	403	479	560	602	295	1.7	651	-15 to +10	-	3/8	1/4	
UNB5144Z	584AG	G	RSIR	ok	ok	-	C	1/5	314	386	472	560	656	705	355	4.2	762	-15 to +10	-	3/8	1/4	
UNB6144Z	584BA	A	CSIR	ok	ok	ok	C-V	1/6+	269	330	403	479	560	602	295	1.7	651	-15 to +10	0.6	3/8	1/4	
UNB6144Z	584BG	G	CSIR	ok	ok	-	C-V	1/5	314	386	472	560	656	705	355	4.2	762	-15 to +10	0.5	3/8	1/4	
UNE5160Z	571AA	A	RSIR	ok	ok	-	C	1/5	320	392	480	570	669	716	380	2.4	779	-15 to +10	-	3/8	1/4	
UNE5160Z	571AN	N	RSIR	ok	ok	-	C	1/5	320	392	480	570	669	716	380	2.4	779	-15 to +10	-	3/8	1/4	
UNE5160Z	571AG	G	RSIR	ok	ok	-	C	1/4	374	458	562	666	783	838	455	5.1	912	-15 to +10	-	3/8	1/4	
UNE6160Z	571BA	A	CSIR	ok	ok	ok	C-V	1/5	320	392	480	570	669	716	380	2.4	779	-15 to +10	1.1	3/8	1/4	
UNE6160Z	571BG	G	CSIR	ok	ok	-	C-V	1/4	374	458	562	666	783	838	455	5.1	912	-15 to +10	1.0	3/8	1/4	
UNE5170Z	571CA	A	RSIR	ok	ok	-	C	1/4	355	440	535	640	753	803	410	2.4	872	-15 to +10	-	3/8	1/4	
UNEK6160Z	557BA	A	CSIR	ok	ok	ok	C-V	1/3	382	468	574	680	800	855	465	2.2	912	-15 to +10	-	3/8	1/4	
UNE5170Z	571CG	G	RSIR	ok	ok	-	C	1/4+	415	514	626	749	881	940	490	5.5	1021	-15 to +10	-	3/8	1/4	
UNE5187Z	571EA	A	RSIR	ok	ok	-	C	1/3	488	613	750	899	1052	1128	562	3.4	1221	-15 to +10	-	3/8	1/4	
UNE5187Z	571EG	G	RSIR	ok	ok	-	C	1/3+	571	717	878	1051	1231	1320	672	7.8	1429	-15 to +10	-	3/8	1/4	
UNE6170Z	571DA	A	CSIR	ok	ok	ok	C-V	1/4	355	440	535	640	753	815	410	2.4	872	-15 to +10	1.1	3/8	1/4	
UNE6170Z	571DN	N	CSIR	ok	ok	ok	C-V	1/4	355	440	535	640	753	815	330	5.1	872	-15 to +10	1.1	3/8	1/4	
UNE6170Z	571DG	G	CSIR	ok	ok	-	C-V	1/4	431	453	557	683	767	963	502	5.4	1121	-15 to +10	1.0	3/8	1/4	
UNEK6170Z	573DA	A	CSIR	ok	ok	ok	C-V	1/4	407	479	595	693	798	855	347	2.1	921	-15 to +10	1.1	3/8	1/4	
UNE6187Z	571FA	A	CSIR	ok	ok	ok	C-V	1/3	481	600	737	894	1070	1153	562	3.2	1264	-15 to +10	1.1	3/8	1/4	
UNEK6187Z	557AA	A	CSIR	ok	ok	ok	C-V	1/3	441	536	679	804	969	1032	410	2.6	1154	-15 to +10	1.1	3/8	1/4	
UNE6187Z	571FG	G	CSIR	ok	ok	-	C-V	1/3+	571	717	878	1051	1231	1320	672	7.8	1429	-15 to +10	1.0	3/8	1/4	
UNE6187Z	571FN	N	CSIR	ok	ok	ok	C-V	1/3	481	600	737	894	1070	1153	562	3.3	1264	-15 to +10	1.1	3/8	1/4	
UNE6210Z	572FA	A	CSIR	ok	ok	ok	C-V	1/3+	543	614	822	980	1148	1228	564	3.3	1330	-15 to +10	1.1	3/8	1/4	
UNEK6210Z	558BA	A	CSIR	ok	ok	ok	C-V	1/3+	430	584	789	929	1065	1228	497	3.3	1203	-15 to +10	1.1	3/8	1/4	
UNE6210Z	572FD	D	CSIR	ok	ok	-	C-V	1/2-	580	739	911	1098	1300	1394	730	7.6	1516	-15 to +10	1.0	3/8	1/4	
UNE6210Z	572FG	G	CSIR	ok	ok	-	C-V	1/2-	580	739	911	1098	1300	1394	730	7.6	1516	-15 to +10	1.0	3/8	1/4	
UNEK6212Z	559BA	A	CSIR/CSR	ok	ok	ok	C-V	1/2+	640	800	975	1157	1354	1448	730	4.4	1601	-15 to +10	1.1	3/8	1/4	
UNEK6214Z	559HA	A	CSIR	ok	ok	ok	C-V	1/2+	658	826	1004	1192	1395	1492	753	4.5	1601	-15 to +10	1.1	3/8	1/4	
UT5213Z	533CT	T	RSIR	ok	ok	-	C	1/2-	651	817	994	1180	1381	1477	745	4.5	1601	-15 to +10	-	3/8	1/4	
UT5213Z	533CG	G	RSIR	ok	ok	-	C	1/2	762	957	1163	1381	1616	1728	892	10.0	1873	-15 to +10	-	3/8	1/4	
UT6213Z	533DG	G	CSIR	ok	ok	-	C-V	1/2	762	957	1163	1381	1616	1728	892	9.6	1873	-15 to +10	1.0	3/8	1/4	
UT6213Z	533DN	N	CSIR	ok	ok	ok	C-V	1/2+	616	774	941	1113	1295	1372	702	4.6	1488	-15 to +10	1.1	3/8	1/4	
UT6213Z	533DT	T	CSIR	ok	ok	ok	C-V	1/2-	651	817	994	1180	1381	1477	745	4.5	1601	-15 to +10	1.1	3/8	1/4	

Notes: \* Version: V-2 - with receiver, with two valves (flare or weld connection) | V-3 - capillary version - without valves, without receiver | V-9 - V2 + selected accessories.

	FAN			FAN MOTOR			WEIGHT (Only Reference) kg / lb	OVERALL DIMENSIONS				CONDENSER		MODEL	
	O.D. mm / inch	No. & Angle of Blades	No. of Fans	Air Flow Rate	Rated Output	Rated Input		Rated Input	A	B	C	DRAWING NUMBER	No. OF ROWS		No. OF TUBES
				m <sup>3</sup> /h	W	W		A							
	230 / 9.06	5/28°	1	320	10	36	0.25	17.7 / 39.0	480 / 18.90	300 / 11.81	254 / 10.00	1955191	3	9	UNE2125E
								435 / 17.13	306 / 12.05	254 / 10.00	1955183				
	230 / 9.06	5/28°	1	320	10	36	0.25	18.7 / 43.4	480 / 18.90	300 / 11.81	254 / 10.00	1955191	3	9	UNE2134E
								435 / 17.13	306 / 12.05	254 / 10.00	1955183				
	230 / 9.06	5/28°	1	320	10	36	0.25	18.7 / 43.4	435 / 17.13	306 / 12.05	254 / 10.00	1955183	3	9	UNE2134E
	254 / 10.00	5/28°	1	580	16	60	0.42	26.0 / 57.3	465 / 18.31	340 / 13.39	296 / 11.65	1955193	4	11	UT2140E
	254 / 10.00	5/28°	1	670	16	58	0.36	26.0 / 57.3	465 / 18.31	340 / 13.39	296 / 11.65	1955193	4	11	UT2140E
	254 / 10.00	5/28°	1	580	16	60	0.42	27.0 / 59.5	465 / 18.31	340 / 13.39	296 / 11.65	1955193	4	11	UT2155E
	254 / 10.00	5/28°	1	580	16	60	0.42	28.0 / 61.7	465 / 18.31	340 / 13.39	296 / 11.65	1955193	4	11	UT2168E
	275 / 10.83	5/31°	1	600	34	110	0.75	34.7 / 76.5	477 / 18.78	410 / 16.14	324 / 12.76	1955186	3	12	UJ2178E
	275 / 10.83	5/31°	1	600	34	110	0.75	38.0 / 83.8	477 / 18.78	410 / 16.14	324 / 12.76	1955186	3	12	UNJ2190E

\*\* Test Conditions: Ambient 32°C (90°F) | Max. subcooling 3°C (5°F) | Evaporator outlet and gas return 32°C (90°F).  
For electrical version D and G, version V-9 on request.

	FAN			FAN MOTOR			WEIGHT (Only Reference) kg / lb	OVERALL DIMENSIONS				CONDENSER		MODEL	
	O.D. mm / inch	No. & Angle of Blades	No. of Fans	Air Flow Rate	Rated Output	Rated Input		Rated Input	A	B	C	DRAWING NUMBER	No. OF ROWS		No. OF TUBES
				m <sup>3</sup> /h	W	W		A							
	200 / 7.87	5/28°	1	240	10	36	0.25	12.6 / 27.8	480 / 18.90	300 / 11.81	226 / 8.90	1955191	2	8	UNB5125Z
								431 / 16.97	306 / 12.05	226 / 8.90	1955183				
	200 / 7.87	5/28°	1	280	9	34	0.45	12.6 / 27.8	431 / 16.97	306 / 12.05	226 / 8.90	1955183	2	8	UNB5125Z
	200 / 7.87	5/28°	1	240	10	36	0.25	13.0 / 28.7	480 / 18.90	300 / 11.81	226 / 8.90	1955191	2	8	UNB5128Z
								431 / 16.97	306 / 12.05	226 / 8.90	1955183				
	200 / 7.87	5/28°	1	280	9	34	0.45	13.2 / 29.1	431 / 16.97	306 / 12.05	226 / 8.90	1955183	2	8	UNB5128Z
	200 / 7.87	5/28°	1	240	10	36	0.25	13.2 / 29.1	480 / 18.90	300 / 11.81	226 / 8.90	1955191	2	8	UNB5132Z
								431 / 16.97	306 / 12.05	226 / 8.90	1955183				
	200 / 7.87	5/28°	1	240	10	36	0.25	13.2 / 29.1	431 / 16.97	306 / 12.05	226 / 8.90	1955183	2	8	UNB5132Z
	200 / 7.87	5/28°	1	245	10	38	0.25	15.5 / 34.2	430 / 16.90	306 / 12.05	226 / 8.90	1955183	3	8	UNB5144Z
								480 / 18.90	300 / 11.81	226 / 8.90	1955191				
	200 / 7.87	5/28°	1	275	9	34	0.45	15.5 / 34.2	430 / 16.90	306 / 12.05	226 / 8.90	1955183	3	8	UNB5144Z
	200 / 7.87	5/28°	1	245	10	38	0.25	16.6 / 36.6	430 / 16.90	306 / 12.05	226 / 8.90	1955183	3	8	UNB6144Z
								480 / 18.90	300 / 11.81	226 / 8.90	1955191				
	200 / 7.87	5/28°	1	275	9	34	0.45	16.6 / 36.6	430 / 16.90	306 / 12.05	226 / 8.90	1955183	3	8	UNB6144Z
	230 / 9.06	5/28°	1	310	10	38	0.25	16.6 / 36.6	480 / 18.90	300 / 11.81	254 / 10.00	1955191	3	9	UNE5160Z
								435 / 17.13	306 / 12.05	254 / 10.00	1955183				
	230 / 9.06	5/28°	1	310	10	38	0.25	16.6 / 36.6	480 / 18.90	300 / 11.81	254 / 10.00	1955191	3	9	UNE5160Z
	230 / 9.06	5/28°	1	310	10	38	0.25	16.6 / 36.6	435 / 17.13	306 / 12.05	254 / 10.00	1955183	3	9	UNE5160Z
	230 / 9.06	5/28°	1	355	9	34	0.45	16.6 / 36.6	435 / 17.13	306 / 12.05	254 / 10.00	1955183	3	9	UNE5160Z
	230 / 9.06	5/28°	1	310	10	38	0.25	16.7 / 36.8	480 / 18.90	300 / 11.81	254 / 10.00	1955191	3	9	UNE6160Z
								435 / 17.13	306 / 12.05	254 / 10.00	1955183				
	230 / 9.06	5/28°	1	355	9	34	0.45	16.7 / 36.8	435 / 17.13	306 / 12.05	254 / 10.00	1955183	3	9	UNE6160Z
	230 / 9.06	5/28°	1	310	10	38	0.25	16.7 / 36.8	480 / 18.90	300 / 11.81	254 / 10.00	1955191	3	9	UNE5170Z
								435 / 17.13	306 / 12.05	254 / 10.00	1955183				
	230 / 9.06	5/28°	1	240	10	36	0.25	17.7 / 39.4	435 / 17.13	306 / 12.05	254 / 10.00	1955183	3	9	UNE5170Z
	230 / 9.06	5/28°	1	355	9	34	0.45	16.7 / 36.8	435 / 17.13	306 / 12.05	254 / 10.00	1955183	3	9	UNE5170Z
	254 / 10.00	5/28°	1	320	16	60	0.42	21.0 / 46.3	465 / 18.31	340 / 13.39	296 / 11.65	1955184	3	11	UNE5187Z
	254 / 10.00	5/28°	1	370	16	58	0.74	21.0 / 46.3	465 / 18.31	340 / 13.39	296 / 11.65	1955184	3	11	UNE5187Z
	230 / 9.06	5/28°	1	310	10	38	0.25	16.7 / 36.8	480 / 18.90	300 / 11.81	254 / 10.00	1955191	3	9	UNE6170Z
								435 / 17.13	306 / 12.05	254 / 10.00	1955183				
	230 / 9.06	5/28°	1	310	10	38	0.25	16.7 / 36.8	480 / 18.90	300 / 11.81	254 / 10.00	1955191	3	9	UNE6170Z
	230 / 9.06	5/28°	1	355	9	34	0.45	16.7 / 36.8	435 / 17.13	306 / 12.05	254 / 10.00	1955183	3	9	UNE6170Z
	230 / 9.06	5/28°	1	310	10	38	0.25	16.7 / 36.8	480 / 18.90	300 / 11.81	254 / 10.00	1955191	3	9	UNE6170Z
								435 / 17.13	306 / 12.05	254 / 10.00	1955183				
	254 / 10.00	5/28°	1	320	16	60	0.42	21.0 / 46.3	465 / 18.31	340 / 13.39	296 / 11.65	1955184	3	11	UNE6187Z
	254 / 10.00	5/28°	1	320	16	60	0.42	21.0 / 46.3	465 / 18.31	340 / 13.39	296 / 11.65	1955184	3	11	UNE6187Z
	254 / 10.00	5/28°	1	370	16	58	0.74	21.0 / 46.3	465 / 18.31	340 / 13.39	296 / 11.65	1955184	3	11	UNE6187Z
	254 / 10.00	5/28°	1	320	16	60	0.42	21.0 / 46.3	465 / 18.31	340 / 13.39	296 / 11.65	1955184	3	11	UNE6187Z
	254 / 10.00	5/28°	1	320	16	60	0.42	21.7 / 47.8	465 / 18.31	340 / 13.39	296 / 11.65	1955184	3	11	UNE6210Z
	254 / 10.00	5/28°	1	320	16	60	0.42	21.7 / 47.8	465 / 18.31	340 / 13.39	296 / 11.65	1955184	3	11	UNE6210Z
	254 / 10.00	5/28°	1	370	16	58	0.36	21.0 / 46.3	465 / 18.31	340 / 13.39	296 / 11.65	1955184	3	11	UNE6210Z
	254 / 10.00	5/28°	1	370	16	58	0.74	21.7 / 47.8	465 / 18.31	340 / 13.39	296 / 11.65	1955184	3	11	UNE6210Z
	254 / 10.00	5/28°	1	320	16	60	0.42	23.0 / 51.2	465 / 18.31	340 / 13.39	296 / 11.65	1955184	3	11	UNE6212Z
	254 / 10.00	5/28°	1	320	16	60	0.42	23.3 / 51.4	465 / 18.31	340 / 13.39	296 / 11.65	1955184	3	11	UNE6214Z
	254 / 10.00	5/28°	1	580	16	60	0.42	23.4 / 51.6	465 / 18.31	340 / 13.39	296 / 11.65	1955185	3	11	UT5213Z
	254 / 10.00	5/28°	1	670	16	58	0.74	23.4 / 51.6	465 / 18.31	340 / 13.39	296 / 11.65	1955185	3	11	UT5213Z
	254 / 10.00	5/28°	1	670	16	58	0.74	23.4 / 51.6	465 / 18.31	340 / 13.39	296 / 11.65	1955185	3	11	UT6213Z
	254 / 10.00	5/28°	1	320	16	60	0.42	26.1 / 58.0	465 / 18.31	340 / 13.39	296 / 11.65	1955185	3	11	UT6213Z
	254 / 10.00	5/28°	1	580	16	65	0.42	23.4 / 51.6	465 / 18.31	340 / 13.39	296 / 11.65	1955185	3	11	UT6213Z

\*\* Test Conditions: Ambient 32°C (90°F) | Max. subcooling 3°C (5°F) | Evaporator outlet and gas return 32°C (90°F).  
For electrical version D and G, version V-9 on request.

# R 134a - HBP

MODEL	B.O.M.	ELECTRICAL VERSION	MOTOR TYPE	VERSION *			EXPANSIVE DEVICE	HP	PERFORMANCE / EVAPORATING TEMPERATURE °C - **										APPLICATION RANGE IN 43°C	RECEIVER VOLUME litre	VALVES TUBE LINE O.D.	
				V-2	V-3	V-9			-15	-10	-5	0	5	RATED 7.2			10	15			SUCTION inch	LIQUID inch
														W	W inp	RLA						
UT6215Z	536ZA	A	CSIR	ok	ok	ok	C-V	1/2	719	833	1040	1255	1473	1572	821	5.5	1699	-15 to +10	1.2	1/2	1/4	
UT6215Z	536ZC	C	CSIR	ok	ok	ok	C-V	1/2	719	833	1040	1255	1473	1572	821	5.5	1699	-15 to +10	1.2	1/2	3/8	
UT6215Z	536ZG	G	CSIR	ok	ok	-	C-V	1/2+	823	1080	1320	1566	1837	1878	1022	11.2	2115	-15 to +10	1.3	1/2	3/8	
UT6215Z	536ZN	N	CSIR	ok	ok	ok	C-V	1/2	719	833	1040	1255	1473	1572	821	5.5	1699	-15 to +10	1.2	1/2	3/8	
U(N)J6220Z	564PA (544PA)	A	CSR	ok	ok	ok	C-V	3/4	1011	1259	1537	1849	2193	2363	1058	6.4	2570	-15 to +10	2.3	1/2	3/8	
U(N)J6220Z	564PD (544PD)	D	CSR	ok	ok	-	C-V	4/5	1163	1470	1790	2156	2520	2673	1330	9.0	2912	-15 to +10	2.3	1/2	3/8	
U(N)J6220Z	564PG (544PG)	G	CSR	ok	ok	-	C-V	4/5	1163	1470	1790	2156	2520	2560	1330	15.0	2912	-15 to +10	2.3	1/2	3/8	
U(N)J6226Z	562EA (542HA)	A	CSR	ok	ok	ok	C-V	1-	1372	1686	2035	2419	2814	3006	1355	6.6	3244	-15 to +10	2.3	5/8	3/8	
U(N)J6226Z	562ED (542HD)	D	CSR	ok	ok	-	C-V	1-	1390	1740	2100	2466	2840	2996	1610	8.2	3323	-15 to +10	2.3	5/8	3/8	
U(N)J6220ZX	568PM (548PM)	M	3 Ph	ok	ok	ok	C-V	3/4-	994	1256	1529	1843	2154	2285	1004	1.6	2488	-15 to +10	2.3	1/2	3/8	
U(N)J6226ZX	566EM (546EM)	M	3 Ph	ok	ok	ok	C-V	1-	1372	1686	2035	2419	2814	2796	1293	2.4	3244	-15 to +10	2.3	5/8	3/8	

Notes: \* Version: V-2 - with receiver, with two valves (flare or weld connection) | V-3 - capillary version - without valves, without receiver | V-9 - V2 + selected accessories.

# R 22 - M/HBP

MODEL	B.O.M.	ELECTRICAL VERSION	MOTOR TYPE	VERSION *			EXPANSIVE DEVICE	HP	PERFORMANCE / EVAPORATING TEMPERATURE °C - **										APPLICATION RANGE IN 43°C	RECEIVER VOLUME litre	VALVES TUBE LINE O.D.	
				V-2	V-3	V-9			-15	-10	-5	0	5	RATED 7.2			10	15			SUCTION inch	LIQUID inch
														W	W inp	RLA						
UNB6144E	684IA	A	CSIR	ok	ok	ok	C-V	1/6	259	313	372	435	506	547	310	2.0	593	-	-15 to +10	0.6	3/8	1/4
UNB6152E	684LA	A	CSIR	ok	ok	ok	C-V	1/5	308	372	442	517	605	645	355	2.2	698	-	-15 to +10	0.6	3/8	1/4
UNB6165E	684NA	A	CSIR	ok	ok	ok	C-V	1/4-	372	451	541	634	733	779	470	2.8	837	-	-15 to +10	1.1	3/8	1/4
UNE6181E	672LA	A	CSIR	ok	ok	ok	C-V	1/4+	442	547	663	784	909	969	530	3.1	1030	-	-15 to +10	1.1	3/8	1/4
UNE6181E	672LG	G	CSIR	ok	ok	-	C-V	1/3	577	681	808	957	1070	1128	680	2.3	1210	-	-15 to +10	1.0	3/8	1/4
UNE6195E	671LG	G	CSIR	ok	ok	-	C-V	1/3+	629	740	872	1022	1190	1278	683	7.5	1378	-	-15 to +10	1.0	3/8	1/4
UNE6210E	671NA	A	CSIR	ok	ok	ok	C-V	1/3+	607	762	926	1102	1279	1365	600	3.4	1450	-	-15 to +10	1.1	3/8	1/4
UNE6210E	671NG	G	CSIR	ok	ok	-	C-V	1/2-	776	895	1101	1299	1347	1493	730	8.1	1576	-	-15 to +10	1.0	3/8	1/4
UNE6210E	671ND	D	CSIR	ok	ok	-	C-V	1/2-	776	895	1101	1299	1347	1493	758	4.2	1576	-	-15 to +10	1.0	3/8	1/4
UNE9213E	673EA	A	CSR	ok	ok	ok	C-V	1/2-	663	829	1000	1198	1390	1483	775	3.6	1650	-	-15 to +10	1.2	3/8	1/4
UNE9213E	673EG	G	CSR	ok	ok	-	C-V	1/2	847	1058	1276	1502	1698	1792	939	8.4	1975	-	-15 to +10	1.3	3/8	1/4
UNE9213E	673ED	D	CSR	ok	ok	-	C-V	1/2	847	1058	1276	1502	1698	1808	939	4.6	1975	-	-15 to +10	1.3	3/8	1/4
UT6217E	636MA	A	CSR	ok	ok	ok	C-V	1/2+	831	1032	1255	1500	1744	1892	778	3.7	2054	-	-15 to +10	2.3	1/2	3/8
UT6217E	636MD	D	CSIR	ok	ok	-	C-V	2/3	909	1158	1424	1709	2013	2152	1069	12.8	2334	-	-15 to +10	2.3	1/2	3/8
UT6217E	636MG	G	CSR	ok	ok	-	C-V	2/3	909	1158	1424	1709	2013	2153	1069	12.3	2334	-	-15 to +10	2.3	1/2	3/8
UT6220E	636LA	A	CSR	ok	ok	ok	C-V	2/3	942	1221	1500	1788	2093	2227	1090	4.6	2407	-	-15 to +10	2.3	1/2	3/8
UT6220E	636LG	G	CSR	ok	ok	-	C-V	3/4	1102	1492	1755	2092	2449	2605	1003	4.2	2816	-	-15 to +10	2.3	1/2	3/8
UT6220E	636LD	D	CSR	ok	ok	-	C-V	3/4	1102	1492	1755	2092	2449	2605	1003	7.0	2816	-	-15 to +10	2.3	1/2	3/8
UT6222E	636YG	G	CSR	ok	ok	-	C-V	3/4+	1361	1643	1900	2224	2608	2880	1264	1.6	3151	-	-15 to +10	2.3	1/2	3/8
UT6222E	636YD	D	CSR	ok	ok	-	C-V	3/4+	1361	1643	1900	2224	2608	2880	1264	1.5	3151	-	-15 to +10	2.3	1/2	3/8
U(N)J9226E	664IV (644IV)	V	CSR	ok	ok	ok	C-V	3/4+	1221	1552	1895	2250	2605	2785	1230	5.8	2965	-	-15 to +10	2.3	5/8	3/8
U(N)J9226E	664IV (644IV)	V	CSR	ok	ok	ok	C-V	3/4+	1221	1552	1895	2250	2605	2785	1230	5.8	2965	-	-15 to +10	2.3	5/8	3/8
U(N)J9226E	664ID (644ID)	D	CSR	ok	ok	-	C-V	1	1461	1645	2076	2587	3176	3500	1124	6.5	3844	-	-15 to +10	2.3	5/8	3/8
U(N)J9226E	664ID (644ID)	D	CSR	ok	ok	-	C-V	1	1461	1645	2076	2587	3176	3500	1124	6.5	3844	-	-15 to +10	2.3	5/8	3/8
U(N)J9226P	668IM (648IM)	M	3 Ph	ok	ok	ok	C-V	1-	1129	1438	1816	2263	2778	3026	1134	3.6	3361	-	-15 to +10	2.3	5/8	3/8
U(N)J7228F	662FA (642FA)	A	CSR	ok	ok	ok	C-V	1-	-	-	-	2409	2796	2974	1296	6.2	3202	3623	0 to +15	2.3	5/8	3/8
UJ7228P	666DM	M	3 Ph	ok	ok	ok	C-V	1-	-	-	-	2442	2837	3023	1300	2.7	3256	3674	0 to +15	2.3	5/8	3/8
U(N)J7231F	664EA (644EA)	A	CSR	ok	ok	ok	C-V	1	-	-	-	2733	3324	3606	1460	6.3	3984	4715	0 to +15	3.9	5/8	1/2
U(N)J7231P	668CM (648CM)	M	3 Ph	ok	ok	ok	C-V	1	-	-	-	2733	3324	3606	1335	3.6	3984	4715	0 to +15	3.9	5/8	1/2
U(N)J9232E	663MV (643MV)	V	CSR	ok	ok	ok	C-V	1 1/5	1901	2279	2680	3140	3628	3860	1470	7.2	4163	-	-15 to +10	3.9	5/8	1/2
U(N)J9232E	663MV (643MV)	V	CSR	ok	ok	ok	C-V	1 1/5	1901	2279	2680	3140	3628	3860	1470	7.9	4163	-	-15 to +10	2.3	5/8	1/2
U(N)J9232P	667HM (647HM)	M	3 Ph	ok	ok	ok	C-V	1 1/5	1895	2233	2628	3047	3512	3721	1620	3.2	4012	-	-15 to +10	3.9	5/8	1/2
U(N)J9232P	667HM (647HM)	M	3 Ph	ok	ok	ok	C-V	1 1/5	1895	2233	2628	3047	3512	3721	1620	3.6	4012	-	-15 to +10	2.3	5/8	1/2
U(N)J7238E	663AA (643AA)	A	CSR	ok	ok	ok	C-V	1 1/3	-	-	-	3337	4058	4428	1959	10.8	4943	5992	0 to +15	3.9	5/8	1/2
U(N)J9238E	663GV (643GV)	V	CSR	ok	ok	ok	C-V	1 1/3	2274	2561	2809	3436	4142	4478	1856	8.7	4927	-	-15 to +10	3.9	5/8	1/2
U(N)J9238E	663GV (643GV)	V	CSR	ok	ok	ok	C-V	1 1/3	2274	2561	2809	3436	4142	4478	1856	8.8	4927	-	-15 to +10	2.3	5/8	1/2
U(N)J9238P	667GM (647GM)	M	3 Ph	ok	ok	ok	C-V	1 1/3	1791	2261	2809	3436	4142	4478	1856	4.4	4927	-	-15 to +10	3.9	5/8	1/2
U(N)J9238P	667GM (647GM)	M	3 Ph	ok	ok	ok	C-V	1 1/3	1791	2261	2809	3436	4142	4478	1856	4.8	4927	-	-15 to +10	2.3	5/8	1/2
U(N)J7240P	667CM (647CM)	M	3 Ph	ok	ok	ok	C-V	1 1/2	-	-	-	4070	4733	5035	2120	4.3	5407	6163	0 to +15	3.9	5/8	1/2
U(N)J7240F	663FA (643FA)	A	CSR	ok	ok	ok	C-V	1 1/2	-	-	-	3627	4455	4851	2048	10.3	5383	6410	0 to +15	3.9	5/8	1/2

Notes: \* Version: V-2 - with receiver, with two valves (flare or weld connection) | V-3 - capillary version - without valves, without receiver | V-9 - V2 + selected accessories.

	FAN			FAN MOTOR			WEIGHT (Only Reference) kg / lb	OVERALL DIMENSIONS				CONDENSER		MODEL	
	O.D. mm / inch	No. & Angle of Blades	No. of Fans	Air Flow Rate	Rated Output	Rated Input		Rated Input	A	B	C	DRAWING NUMBER	No. OF ROWS		No. OF TUBES
				m <sup>3</sup> /h	W	W		A	mm / inch	mm / inch	mm / inch				
	254 / 10.00	5/28°	1	580	25	90	0.62	24.5 / 54.5	465 / 18.31	340 / 13.39	296 / 11.65	1955185	3	11	UT6215Z
	254 / 10.00	5/28°	1	580	25	110	0.62	26.5 / 58.4	465 / 18.31	340 / 13.39	296 / 11.65	1955185	3	11	UT6215Z
	254 / 10.00	5/28°	1	670	25	110	1.10	26.5 / 58.4	465 / 18.31	340 / 13.39	296 / 11.65	1955185	3	11	UT6215Z
	254 / 10.00	5/28°	1	580	25	110	0.62	26.5 / 58.4	465 / 18.31	340 / 13.39	296 / 11.65	1955185	3	11	UT6215Z
	275 / 10.83	5/31°	1	800	34	110	0.75	34.7 / 76.5	477 / 18.78	410 / 16.14	324 / 12.76	1955186	4	12	U(N)J6220Z
	275 / 10.83	5/31°	1	900	25	80	0.55	34.7 / 76.5	477 / 18.78	410 / 16.14	324 / 12.76	1955186	4	12	U(N)J6220Z
	275 / 10.83	5/31°	1	900	25	80	1.10	34.7 / 76.5	477 / 18.78	410 / 16.14	324 / 12.76	1955186	4	12	U(N)J6220Z
	275 / 10.83	5/31°	1	800	34	110	0.75	37.5 / 82.7	477 / 18.78	410 / 16.14	324 / 12.76	1955186	4	12	U(N)J6226Z
	275 / 10.83	5/31°	1	900	25	80	0.55	37.5 / 82.7	477 / 18.78	410 / 16.14	324 / 12.76	1955186	4	12	U(N)J6226Z
	275 / 10.83	5/31°	1	850	34	100	0.38	34.7 / 76.5	477 / 18.78	410 / 16.14	324 / 12.76	1955186	4	12	U(N)J6220ZX
	275 / 10.83	5/31°	1	850	34	100	0.38	34.7 / 76.5	477 / 18.78	410 / 16.14	324 / 12.76	1955186	4	12	U(N)J6226ZX

\*\* Test Conditions: Ambient 32°C (90°F) | Max. subcooling 3°C (5°F) | Evaporator outlet and gas return 32°C (90°F).  
For electrical version D and G, version V-9 on request.

	FAN			FAN MOTOR			WEIGHT (Only Reference) kg / lb	OVERALL DIMENSIONS				CONDENSER		MODEL	
	O.D. mm / inch	No. & Angle of Blades	No. of Fans	Air Flow Rate	Rated Output	Rated Input		Rated Input	A	B	C	DRAWING NUMBER	No. OF ROWS		No. OF TUBES
				m <sup>3</sup> /h	W	W		A	mm / inch	mm / inch	mm / inch				
	200 / 7.87	5/28°	1	240	10	36	0.25	17.4 / 38.4	480 / 18.90	300 / 11.81	226 / 8.90	1955191	3	8	UNB6144E
	200 / 7.87	5/28°	1	240	10	36	0.25	17.4 / 38.4	430 / 16.90	306 / 12.05	226 / 8.90	1955183	3	8	UNB6152E
	200 / 7.87	5/28°	1	240	10	36	0.25	17.4 / 38.4	480 / 18.90	300 / 11.81	226 / 8.90	1955191	3	8	UNB6152E
	230 / 9.06	5/28°	1	340	10	36	0.25	17.9 / 39.5	435 / 17.13	306 / 12.05	254 / 10.00	1955183	3	9	UNB6165E
	254 / 10.00	5/28°	1	320	16	60	0.42	20.0 / 44.1	465 / 18.31	340 / 13.39	296 / 11.65	1955184	3	11	UNE6181E
	254 / 10.00	5/28°	1	370	16	58	0.74	20.0 / 44.1	465 / 18.31	340 / 13.39	296 / 11.65	1955184	3	11	UNE6181E
	254 / 10.00	5/28°	1	370	16	58	0.74	20.0 / 44.1	465 / 18.31	340 / 13.39	296 / 11.65	1955184	3	11	UNE6195E
	254 / 10.00	5/28°	1	320	16	60	0.42	20.8 / 45.8	465 / 18.31	340 / 13.39	296 / 11.65	1955184	3	11	UNE6210E
	254 / 10.00	5/28°	1	370	16	58	0.74	20.5 / 45.2	465 / 18.31	340 / 13.39	296 / 11.65	1955184	3	11	UNE6210E
	254 / 10.00	5/28°	1	370	16	58	0.36	20.5 / 45.2	465 / 18.31	340 / 13.39	296 / 11.65	1955184	3	11	UNE6210E
	254 / 10.00	5/28°	1	320	16	60	0.42	20.8 / 45.8	505 / 19.88	340 / 13.39	296 / 11.65	1955190	3	11	UNE9213E
	254 / 10.00	5/28°	1	370	16	58	0.74	20.8 / 45.8	505 / 19.88	340 / 13.39	296 / 11.65	1955190	3	11	UNE9213E
	254 / 10.00	5/28°	1	370	25	110	0.55	20.8 / 45.8	505 / 19.88	340 / 13.39	296 / 11.65	1955190	3	11	UNE9213E
	275 / 10.83	5/31°	1	600	34	110	0.75	31.7 / 39.9	518 / 20.39	395 / 15.55	324 / 12.76	1955194	3	12	UT6217E
	275 / 10.83	5/31°	1	700	25	80	0.55	31.7 / 39.9	518 / 20.39	395 / 15.55	324 / 12.76	1955194	3	12	UT6217E
	275 / 10.83	5/31°	1	700	34	100	1.35	31.7 / 39.9	518 / 20.39	395 / 15.55	324 / 12.76	1955194	3	12	UT6217E
	275 / 10.83	5/31°	1	800	34	110	0.75	32.2 / 70.9	518 / 20.39	395 / 15.55	324 / 12.76	1955194	3	12	UT6220E
	275 / 10.83	5/31°	1	900	25	80	1.10	32.2 / 70.9	518 / 20.39	395 / 15.55	324 / 12.76	1955194	3	12	UT6220E
	275 / 10.83	5/31°	1	900	25	80	0.55	32.2 / 70.9	518 / 20.39	395 / 15.55	324 / 12.76	1955194	3	12	UT6220E
	275 / 10.83	5/31°	1	900	34	100	1.35	34.7 / 76.5	518 / 20.39	395 / 15.55	324 / 12.76	1955194	3	12	UT6222E
	275 / 10.83	5/31°	1	900	25	80	0.55	34.7 / 76.5	518 / 20.39	395 / 15.55	324 / 12.76	1955194	3	12	UT6222E
	300 / 11.81	5/28°	1	850	34	110	0.75	37.5 / 82.7	507 / 19.96	410 / 16.14	390 / 15.35	1955195	4	14	U(N)J9226E
	2x254/10.00	5/28°	2	1400	2x16	2x60	2x0.42	40.0 / 88.2	440 / 17.32	612 / 24.09	323 / 12.72	1955381	3	11	U(N)J9226E
	300 / 11.81	5/28°	1	980	25	80	0.55	37.5 / 82.7	507 / 19.96	410 / 16.14	390 / 15.35	1955195	4	14	U(N)J9226E
	2x254/10.00	5/28°	2	1400	2x16	2x60	2x0.42	40.0 / 88.2	440 / 17.32	612 / 24.09	323 / 12.72	1955381	3	11	U(N)J9226E
	300 / 11.81	5/28°	1	980	34	100	0.38	42.5 / 93.7	507 / 19.96	410 / 16.14	390 / 15.35	1955195	4	14	U(N)J9226P
	300 / 11.81	5/28°	1	850	34	110	0.75	40.0 / 88.2	507 / 19.96	410 / 16.14	390 / 15.35	1955195	4	14	U(N)J9228F
	275 / 10.83	5/31°	1	800	34	110	0.38	42.5 / 93.7	477 / 18.78	410 / 16.14	324 / 12.76	1955186	4	12	UJ7228P
	300 / 11.81	6/27°	1	1200	60	120	0.51	42.8 / 94.3	600 / 23.62	503 / 19.80	396 / 15.59	1955160	3	14	U(N)J7231F
	300 / 11.81	6/27°	1	1100	65	120	0.45	42.8 / 94.3	600 / 23.62	503 / 19.80	396 / 15.59	1955160	3	14	U(N)J7231P
	300 / 11.81	6/27°	1	1200	60	120	0.51	43.8 / 96.6	600 / 23.62	503 / 19.80	396 / 15.59	1955160	3	14	U(N)J9232E
	2x254/10.00	5/28°	2	1400	2x16	2x60	2x0.42	44.0 / 97.0	460 / 18.11	783 / 30.83	313 / 12.32	1955381	3	11	U(N)J9232E
	300 / 11.81	6/27°	1	1100	65	120	0.45	44.0 / 97.0	600 / 23.62	503 / 19.80	396 / 15.59	1955160	3	14	U(N)J9232P
	2x254/10.00	5/28°	2	1400	2x16	2x60	2x0.42	44.0 / 97.0	460 / 18.11	783 / 30.83	313 / 12.32	1955381	3	11	U(N)J9232P
	350 / 13.78	4/18°	1	1200	60	120	0.51	45.3 / 99.9	600 / 23.62	503 / 19.80	421 / 16.57	1955160	4	15	U(N)J7238E
	350 / 13.78	4/18°	1	1200	60	120	0.51	45.3 / 99.9	600 / 23.62	503 / 19.80	421 / 16.57	1955160	4	15	U(N)J9238E
	2x254/10.00	5/28°	2	1400	2x16	2x60	2x0.42	45.0 / 99.2	460 / 18.11	783 / 30.83	313 / 12.32	1955381	4	11	U(N)J9238E
	350 / 13.78	4/18°	1	1200	65	120	0.45	45.3 / 99.9	600 / 23.62	503 / 19.80	421 / 16.57	1955160	4	15	U(N)J9238P
	2x254/10.00	5/28°	2	1400	2x16	2x60	2x0.42	45.0 / 99.2	460 / 18.11	783 / 30.83	313 / 12.32	1955381	4	11	U(N)J9238P
	350 / 13.78	4/18°	1	1200	65	120	0.45	45.8 / 100.1	600 / 23.62	503 / 19.80	421 / 16.57	1955160	4	15	U(N)J7240P
	350 / 13.78	4/18°	1	1200	60	120	0.51	46.8 / 103.2	600 / 23.62	503 / 19.80	421 / 16.57	1955160	4	15	U(N)J7240F

\*\* Test Conditions: Ambient 32°C (90°F) | Max. subcooling 3°C (5°F) | Evaporator outlet and gas return 32°C (90°F).  
For electrical version D and G, version V-9 on request.

# R 404A / R 507 - MBP

MODEL	B.O.M.	ELECTRICAL VERSION	MOTOR TYPE	VERSION *			EXPANSIVE DEVICE	HP	PERFORMANCE / EVAPORATING TEMPERATURE °C - **											APPLICATION RANGE IN 43°C °C	RECEIVER VOLUME litre	VALVES TUBE LINE O.D.	
				V-2	V-3	V-9			-20	-15	-10	-5	0	5	RATED 7.2			10	SUCTION inch			LIQUID inch	
															W	W <sub>inp</sub>	RLA						W
UNB6144GK	684JA	A	CSIR	ok	ok	ok	C-V	1/6	228	283	341	402	467	537	570	362	2.3	610	-20 to 0	0.6	3/8	1/4	
UNB6144GK	684JG	G	CSIR	ok	ok	-	C-V	1/5	280	342	410	483	563	647	687	389	5.0	738	-20 to 0	0.5	3/8	1/4	
UNB6152GK	684MA	A	CSIR	ok	ok	ok	C-V	1/5	239	296	362	436	519	602	654	501	2.6	726	-20 to 0	0.6	3/8	1/4	
UNB6165GK	684OA	A	CSIR	ok	ok	ok	C-V	1/5	271	336	405	478	556	638	677	410	3.0	711	-20 to 0	1.1	3/8	1/4	
UNEK6144GK	557GA	A	CSIR	ok	ok	ok	C-V	1/5+	240	298	359	423	490	564	600	380	2.5	640	-20 to 0	-	3/8	1/4	
UNEK6165GK	557IA	A	CSIR	ok	ok	ok	C-V	1/4	382	429	504	588	660	771	805	471	2.5	867	-20 to 0	1.1	3/8	1/4	
UNB6165GK	684OG	G	CSIR	ok	ok	-	C-V	1/4	328	392	459	524	636	763	823	517	7.7	903	-20 to 0	1.0	3/8	1/4	
UNE6181GK	672UA	A	CSIR	ok	ok	ok	C-V	1/3	406	505	613	730	856	990	1192	590	2.7	1130	-20 to 0	1.1	3/8	1/4	
UNEK6181GK	557MA	A	CSIR	ok	ok	ok	C-V	1/2	427	530	644	767	900	1040	1252	620	2.8	1130	-20 to 0	1.1	3/8	1/4	
UNE6181GK	672UG	G	CSIR	ok	ok	-	C-V	1/2-	420	556	716	903	1115	1532	1480	582	7.2	1616	-20 to 0	1.0	3/8	1/4	
UNE6181GK	672UN	N	CSIR	ok	ok	ok	C-V	1/3	406	505	613	730	856	990	1052	590	3.5	1130	-20 to 0	1.0	3/8	1/4	
UNE6195GK	671WG	G	CSIR	ok	ok	-	C-V	1/2-	423	568	725	914	1122	1370	1500	565	7.9	1640	-20 to 0	1.0	3/8	1/4	
UNE6210GK	671YA	A	CSIR	ok	ok	ok	C-V	1/3	470	557	663	786	928	1087	1164	652	3.8	1265	-20 to 0	1.1	3/8	1/4	
UNEK6210GK	674CA	A	CSIR	ok	ok	ok	C-V	1/3+	581	670	665	886	1032	1228	1302	628	3.5	1428	-20 to 0	1.1	3/8	1/4	
UNE6210GK	671YD	D	CSIR	ok	ok	-	C-V	1/3+	519	690	852	1003	1144	1279	1329	652	3.8	1394	-20 to 0	1.1	3/8	1/4	
UNEK6213GK	659BA	A	CSIR	ok	ok	ok	C-V	1/2-	734	904	1064	1213	1352	1468	1531	1074	6.0	1787	-20 to 0	1.1	3/8	1/4	
UNEK6217GK	559GA	A	CSIR	ok	ok	ok	C-V	1/2+	741	960	1180	1406	1640	1880	1985	1136	5.3	2058	-20 to 0	2.3	1/2	3/8	
UNE9213GK	673XA	A	CSR	ok	ok	ok	C-V	1/2-	626	785	945	1106	1267	1430	1502	843	3.9	1756	-20 to 0	1.2	3/8	1/4	
UNE9213GK	673XG	G	CSR	ok	ok	-	C-V	1/2	689	815	1016	1267	1480	1669	1741	1218	9.7	1827	-20 to 0	1.3	3/8	1/4	
UT6217GK	636VA	A	CSIR	ok	ok	ok	C-V	1/2+	719	931	1144	1365	1591	1822	1926	1102	5.1	2058	-20 to 0	2.3	1/2	3/8	
UT6217GK	636VG	G	CSR	ok	ok	-	C-V	2/3-	740	1023	1280	1515	1724	1854	1990	1283	14.3	2072	-20 to 0	2.3	1/2	3/8	
UT6217GK	636VD	D	CSIR	ok	ok	-	C-V	2/3-	740	1023	1280	1515	1724	1854	1985	1283	7.3	2072	-20 to 0	2.3	1/2	3/8	
UT6220GK	636RA	A	CSR	ok	ok	ok	C-V	3/4-	856	1106	1363	1626	1894	2170	2293	1212	5.6	2450	-20 to 0	2.3	1/2	3/8	
UT6220GK	636RG	G	CSR	ok	ok	-	C-V	3/4+	1002	1294	1595	1902	2216	2539	2683	1331	16.5	2867	-20 to 0	2.3	1/2	3/8	
UT6220GK	636RD	D	CSR	ok	ok	-	C-V	3/4+	1002	1294	1595	1902	2216	2539	2683	1134	7.9	2867	-20 to 0	2.3	1/2	3/8	
UT6222GK	636ZA	A	CSR	ok	ok	ok	C-V	3/4	1105	1370	1636	1899	2162	2424	2540	1419	6.8	2686	-20 to 0	2.3	1/2	3/8	
UT6222GK	636ZG	G	CSR	ok	ok	-	C-V	1-	1307	1530	1802	1900	2251	2712	3000	1426	17.1	3214	-20 to 0	2.3	1/2	3/8	
UT6222GK	636ZD	D	CSR	ok	ok	-	C-V	1-	1307	1530	1802	1900	2251	2712	3000	1426	9.5	3214	-20 to 0	2.3	1/2	3/8	
U(N)J9226GK	664LV (644LV)	V	CSR	ok	ok	ok	C-V	1-	1328	1537	1851	2179	2522	2879	3042	1403	6.4	3250	-20 to 0	2.3	5/8	3/8	
U(N)J9226GK	664LV (644LV)	V	CSR	ok	ok	ok	C-V	1-	1328	1537	1851	2179	2522	2879	3041	1403	6.4	3250	-20 to 0	2.3	5/8	3/8	
U(N)J9226GK	664LD (644LD)	D	CSR	ok	ok	-	C-V	1 1/6	1522	1745	2077	2338	2890	3508	3850	1432	9.7	4194	-20 to 0	2.3	5/8	3/8	
U(N)J9226GK	664LD (644LD)	D	CSR	ok	ok	-	C-V	1 1/6	1522	1745	2077	2338	2890	3508	3850	1432	9.1	4194	-20 to 0	2.3	5/8	3/8	
U(N)J9226GS	668LM (648LM)	M	3 Ph	ok	ok	ok	C-V	1-	1206	1523	1822	2094	2364	2616	2720	1300	3.9	2831	-20 to 0	2.3	5/8	3/8	
U(N)J9226GS	668LM (648LM)	M	3 Ph	ok	ok	ok	C-V	1-	1206	1523	1822	2094	2364	2616	2720	1300	3.9	2831	-20 to 0	2.3	5/8	3/8	
U(N)J9232GK	664FV (643NA)	A	CSR	ok	ok	ok	C-V	1	1422	1766	2115	2469	2830	3196	3361	1719	8.4	3569	-20 to 0	3.9	5/8	1/2	
U(N)J9232GK	664FV (643NA)	A	CSR	ok	ok	ok	C-V	1	1422	1766	2115	2469	2830	3196	3361	1719	8.5	3569	-20 to 0	2.3	5/8	1/2	
U(N)J9232GS	668FM (647NM)	M	3 Ph	ok	ok	ok	C-V	1	1467	1855	2219	2550	2879	3186	3365	1685	3.4	3448	-20 to 0	3.9	5/8	1/2	
U(N)J9232GS	668FM (647NM)	M	3 Ph	ok	ok	ok	C-V	1	1467	1855	2219	2550	2879	3186	3365	1709	3.7	3448	-20 to 0	2.3	5/8	1/2	
U(N)J9238GK	663UV (643RV)	V	CSR	ok	ok	ok	C-V	1 1/4	1748	2147	2560	3157	3434	3895	4104	2221	10.0	4372	-20 to 0	3.9	5/8	1/2	
U(N)J9238GK	663UV (643RV)	V	CSR	ok	ok	ok	C-V	1 1/4	1748	2147	2560	3157	3434	3895	4104	2221	10.4	4372	-20 to 0	2.3	5/8	1/2	
U(N)J9238GS	667UM (647RM)	M	3 Ph	ok	ok	ok	C-V	1 1/4	1817	2297	2748	3157	3565	3983	4166	2185	4.4	4269	-20 to 0	3.9	5/8	1/2	
U(N)J9238GS	667UM (647RM)	M	3 Ph	ok	ok	ok	C-V	1 1/4	1817	2297	2748	3157	3565	3983	4166	2215	4.8	4269	-20 to 0	2.3	5/8	1/2	

Notes: \* Version: V-2 - with receiver, with two valves (flare or weld connection) | V-3 - capillary version - without valves, without receiver | V-9 - V2 + selected accessories.

## General Information

### Motor Type

Type	Description
RSIR	Resistive Start Inductive Run
RSCR	Resistive Start Capacitive Run
CSIR	Capacitive Start Inductive Run
CSR	Capacitive Start and Run
PSC	Permanent Split Capacitor
3 Ph	Three Phase

### Expansion Device

Type	Description
C	Capillary
V	Expansion Valve

	FAN				FAN MOTOR			WEIGHT (Only Reference)  kg / lb	OVERALL DIMENSIONS				CONDENSER		MODEL
	O.D. mm / inch	No. & Angle of Blades	No. of Fans	Air Flow Rate*	Rated Output	Rated Input	Rated Input		A	B	C	DRAWING NUMBER	No. OF ROWS	No. OF TUBES	
				m³/h	W	W	A		mm / inch	mm / inch	mm / inch				
200 / 7.87	5/28°	1	240	10	36	0.25	17.4 / 38.4	480 / 18.90	300 / 11.81	226 / 8.90	1955191	3	8	UNB6144GK	
200 / 7.87	5/28°	1	260	9	34	0.45	17.4 / 38.4	430 / 16.90	306 / 12.05	226 / 8.90	1955183	3	8	UNB6144GK	
200 / 7.87	5/28°	1	240	10	36	0.25	17.4 / 38.4	480 / 18.90	300 / 11.81	226 / 8.90	1955191	3	8	UNB6152GK	
230 / 9.06	5/28°	1	340	10	36	0.25	17.9 / 39.5	480 / 18.90	300 / 11.81	254 / 10.00	1955191	3	9	UNB6165GK	
230 / 9.06	5/28°	1	340	10	36	0.25	17.8 / 39.4	435 / 17.13	306 / 12.05	254 / 10.00	1955183	3	9	UNEK6144GK	
230 / 9.06	5/28°	1	340	10	36	0.25	17.9 / 39.5	480 / 18.90	300 / 11.81	254 / 10.00	1955191	3	9	UNEK6165GK	
230 / 9.06	5/28°	1	370	9	34	0.45	17.9 / 39.5	435 / 17.13	306 / 12.05	254 / 10.00	1955183	3	9	UNB6165GK	
254 / 10.00	5/28°	1	320	16	60	0.42	20.0 / 44.1	465 / 18.31	340 / 13.39	296 / 11.65	1955184	3	11	UNEK6181GK	
254 / 10.00	5/28°	1	320	16	60	0.42	21.6 / 48.0	465 / 18.31	340 / 13.39	296 / 11.65	1955184	3	11	UNEK6181GK	
254 / 10.00	5/28°	1	370	16	58	0.74	20.0 / 44.1	465 / 18.31	340 / 13.39	296 / 11.65	1955184	3	11	UNEK6181GK	
254 / 10.00	5/28°	1	320	16	60	0.42	20.0 / 44.1	465 / 18.31	340 / 13.39	296 / 11.65	1955184	3	11	UNEK6181GK	
254 / 10.00	5/28°	1	370	16	58	0.74	20.0 / 44.1	465 / 18.31	340 / 13.39	296 / 11.65	1955184	3	11	UNEK6195GK	
254 / 10.00	5/28°	1	320	16	60	0.42	20.8 / 45.8	465 / 18.31	340 / 13.39	296 / 11.65	1955184	3	11	UNEK6210GK	
254 / 10.00	5/28°	1	320	16	60	0.42	20.8 / 45.8	465 / 18.31	340 / 13.39	296 / 11.65	1955184	3	11	UNEK6210GK	
254 / 10.00	5/28°	1	370	16	58	0.36	20.5 / 45.2	465 / 18.31	340 / 13.39	296 / 11.65	1955184	3	11	UNEK6210GK	
254 / 10.00	5/28°	1	320	16	60	0.42	20.8 / 45.8	465 / 18.31	340 / 13.39	296 / 11.65	1955184	3	11	UNEK6213GK	
275 / 10.83	5/31°	1	600	34	110	0.75	30.2 / 67.2	518 / 20.39	395 / 15.55	324 / 12.76	1955194	3	12	UNEK6217GK	
254 / 10.00	5/28°	1	320	16	60	0.42	20.8 / 45.8	505 / 19.88	340 / 13.39	296 / 11.65	1955190	3	11	UNE9213GK	
254 / 10.00	5/28°	1	370	16	58	0.74	20.8 / 45.8	505 / 19.88	340 / 13.39	296 / 11.65	1955190	3	11	UNE9213GK	
275 / 10.83	5/31°	1	600	34	110	0.75	31.7 / 39.9	518 / 20.39	395 / 15.55	324 / 12.76	1955194	3	12	UT6217GK	
275 / 10.83	5/31°	1	700	34	100	1.35	31.7 / 39.9	518 / 20.39	395 / 15.55	324 / 12.76	1955194	3	12	UT6217GK	
275 / 10.83	5/31°	1	700	25	80	0.55	31.7 / 39.9	518 / 20.39	395 / 15.55	324 / 12.76	1955194	3	12	UT6217GK	
275 / 10.83	5/31°	1	800	34	110	0.75	32.2 / 70.9	518 / 20.39	395 / 15.55	324 / 12.76	1955194	3	12	UT6220GK	
275 / 10.83	5/31°	1	900	25	80	1.10	32.2 / 70.9	518 / 20.39	395 / 15.55	324 / 12.76	1955194	3	12	UT6220GK	
275 / 10.83	5/31°	1	900	25	80	0.55	32.2 / 70.9	518 / 20.39	395 / 15.55	324 / 12.76	1955194	3	12	UT6220GK	
275 / 10.83	5/31°	1	800	34	110	0.75	34.7 / 76.5	518 / 20.39	395 / 15.55	324 / 12.76	1955194	3	12	UT6222GK	
275 / 10.83	5/31°	1	900	34	100	1.35	34.7 / 76.5	518 / 20.39	395 / 15.55	324 / 12.76	1955194	3	12	UT6222GK	
275 / 10.83	5/31°	1	900	25	80	0.55	34.7 / 76.5	518 / 20.39	395 / 15.55	324 / 12.76	1955194	3	12	UT6222GK	
300 / 11.81	5/28°	1	850	34	110	0.75	37.5 / 82.7	507 / 19.96	410 / 16.14	390 / 15.35	1955195	4	14	U(N)J9226GK	
2x254/10.00	5/28°	2	1400	2x16	2x60	2x0.42	40.0 / 88.2	440 / 17.32	612 / 24.09	323 / 12.72	1955381	3	11	U(N)J9226GK	
300 / 11.81	5/28°	1	980	34	100	0.65	37.5 / 82.7	507 / 19.96	410 / 16.14	390 / 15.35	1955195	4	14	U(N)J9226GK	
2x254/10.00	5/28°	2	1400	2x16	2x60	2x0.42	40.0 / 88.2	440 / 17.32	612 / 24.09	323 / 12.72	1955381	3	11	U(N)J9226GK	
300 / 11.81	5/28°	1	980	34	100	0.38	42.5 / 93.7	507 / 19.96	410 / 16.14	390 / 15.35	1955195	4	14	U(N)J9226G5	
2x254/10.00	5/28°	2	1400	2x16	2x60	2x0.42	40.0 / 88.2	440 / 17.32	612 / 24.09	323 / 12.72	1955381	3	11	U(N)J9226G5	
300 / 11.81	6/27°	1	1100	60	120	0.51	42.3 / 93.2	600 / 23.62	503 / 19.80	396 / 15.59	1955160	3	14	U(N)J9232GK	
2x254/10.00	5/28°	2	1400	2x16	2x60	2x0.42	44.0 / 97.0	460 / 18.11	783 / 30.83	313 / 12.32	1955381	3	11	U(N)J9232GK	
300 / 11.81	6/27°	1	1100	65	120	0.45	43.8 / 96.5	600 / 23.62	503 / 19.80	396 / 15.59	1955160	3	14	U(N)J9232G5	
2x254/10.00	5/28°	2	1400	2x16	2x60	2x0.42	44.0 / 97.0	460 / 18.11	783 / 30.83	313 / 12.32	1955381	3	11	U(N)J9232G5	
350 / 13.78	4/18°	1	1200	60	120	0.51	45.3 / 99.9	600 / 23.62	503 / 19.80	421 / 16.57	1955160	4	15	U(N)J9238GK	
2x254/10.00	5/28°	2	1400	2x16	2x60	2x0.42	45.0 / 99.2	460 / 18.11	783 / 30.83	313 / 12.32	1955381	4	11	U(N)J9238GK	
350 / 13.78	4/18°	1	1200	60	120	0.51	45.3 / 99.9	600 / 23.62	503 / 19.80	421 / 16.57	1955160	4	15	U(N)J9238G5	
2x254/10.00	5/28°	2	1400	2x16	2x60	2x0.42	45.0 / 99.2	460 / 18.11	783 / 30.83	313 / 12.32	1955381	4	11	U(N)J9238G5	

\*\* Test Conditions: Ambient 32°C (90°F) | Max. subcooling 3°C (5°F) | Evaporator outlet and gas return 32°C (90°F).  
For electrical version D and G, version V-9 on request.

## Electrical Version

Type	Description
A	220-240V 50Hz
D	208-230V 60Hz
G	115V 60Hz (100V 50Hz)
M	380-420V 50Hz (440-480V 60Hz)
N	200-240V 50Hz (230V 60Hz)
V	230V 50Hz

# AVAILABLE ACCESSORIES

## R 134a - LBP

MODEL	FILTER DRIER (1) TYPE	FILTER DRIER (2) TYPE	SIGHT GLASS TYPE	PRESSURE CONTROL TYPE	SOLENOID VALVE TYPE	OIL SEPARATOR TYPE	SUCTION ACCUMULATOR TYPE	FAN SPEED CONTROLLER TYPE	SCHRADER VALVE CODE	HOUSING CODE	POWER CORD CABLE CODE
UNB1112Z	SM2/30	-	-	-	-	-	-	-	1.022.024	1.957.003	2.258.064
UNB1116Z	SM2/30	-	-	-	-	-	-	-	1.022.024	1.957.003	2.258.064
UNB2116Z	SM2/30	ADK-036MMS	MIAM06	ALCO PS2 A7A	110 RB 2	-	A08-304	-	1.022.024	1.957.003	2.258.064
UNB1118Z	SM2/30	-	-	-	-	-	-	-	1.022.024	1.957.003	2.258.064
UNB2118Z	SM2/30	ADK-036MMS	MIAM06	ALCO PS2 A7A	110 RB 2	-	A08-304	-	1.022.024	1.957.003	2.258.064
UNE1121Z	SM2/30	-	-	-	-	-	-	-	1.022.024	1.957.003	2.258.064
UNE2121Z	SM2/30	ADK-036MMS	MIAM06	ALCO PS2 A7A	110 RB 2	-	A08-304	-	1.022.024	1.957.003	2.258.064
UNE1130Z	SM2/30	-	-	-	-	-	-	-	1.022.024	1.957.003	2.258.064
UNE2130Z	SM2/30	ADK-036MMS	MIAM06	ALCO PS2 A7A	110 RB 2	-	A08-304	-	1.022.024	1.957.003	2.258.064
UT2134Z	SM2/30	ADK-036MMS	MIAM06	ALCO PS2 A7A	110 RB 2	Temprite 900	A08-304	FSX-42U	1.022.024	1.957.003	2.258.036
UT1140Z	SM2/30	-	-	-	-	-	-	-	1.022.024	1.957.003	2.258.036
UT2140Z	SM2/30	ADK-036MMS	MIAM06	ALCO PS2 A7A	110 RB 2	Temprite 900	A08-304	FSX-42U	1.022.024	1.957.003	2.258.036
UJ2152Z	SM2/30	ADK-0510MMS	MIAM10	ALCO PS2 A7A	200 RB 3	Temprite 900	A08-304	FSX-42U	1.022.024	1.957.003	2.258.036

**Notes:**

Accessories (drier, sight glass, pressure controls, suction accumulator, fan speed controller and solenoid valve) supplied by Alco.

Components from other suppliers are available upon request. Thermostat cable available upon request. AC Axial fan motor EBM upon request. Energy saving motor EBM on request.

## R 400A / R 507 - LBP

MODEL	FILTER DRIER (1) TYPE	FILTER DRIER (2) TYPE	SIGHT GLASS TYPE	PRESSURE CONTROL TYPE	SOLENOID VALVE TYPE	OIL SEPARATOR TYPE	SUCTION ACCUMULATOR TYPE	FAN SPEED CONTROLLER TYPE	SCHRADER VALVE CODE	HOUSING CODE	POWER CORD CABLE CODE
UNB2121GK	SM2/30	ADK-036MMS	MIAM06	ALCO PS2 A7A	110 RB 2	-	A08-304	-	1.022.024	1.957.003	2.258.064
UNE2125GK	SM2/30	ADK-036MMS	MIAM06	ALCO PS2 A7A	110 RB 2	-	A08-304	-	1.022.024	1.957.003	2.258.064
UNEK2125GK	SM2/30	ADK-036MMS	MIAM06	ALCO PS2 A7A	110 RB 2	-	A08-304	-	1.022.024	1.957.003	2.258.064
UNEK2134GK	SM2/30	ADK-036MMS	MIAM06	ALCO PS2 A7A	110 RB 2	-	A08-304	-	1.022.024	1.957.003	2.258.064
UNEK2134GK	SM2/30	ADK-036MMS	MIAM06	ALCO PS2 A7A	110 RB 2	-	A08-304	-	1.022.024	1.957.003	2.258.064
UNEK2150GK	SM2/30	ADK-036MMS	MIAM06	ALCO PS2 A7A	110 RB 2	-	A08-304	-	1.022.024	1.957.003	2.258.064
UNEK2168GK	SM2/30	ADK-036MMS	MIAM06	ALCO PS2 A7A	110 RB 2	Temprite 900	A08-304	FSX-42U	1.022.024	1.957.003	2.258.036
UT2155GK	SM2/30	ADK-036MMS	MIAM06	ALCO PS2 A7A	110 RB 2	Temprite 900	A08-304	FSX-42U	1.022.024	1.957.003	2.258.036
UT2168GK	SM2/30	ADK-036MMS	MIAM06	ALCO PS2 A7A	110 RB 2	Temprite 900	A08-304	FSX-42U	1.022.024	1.957.003	2.258.036
UT2178GK	SM2/30	ADK-036MMS	MIAM06	ALCO PS2 A7A	110 RB 2	Temprite 900	A08-304	FSX-42U	1.022.024	1.957.003	2.258.036
UT2180GK	SM2/30	ADK-036MMS	MIAM06	ALCO PS2 A7A	110 RB 2	Temprite 900	A08-304	FSX-42U	1.022.024	1.957.003	2.258.036
UNT2198GK	SM2/30	ADK-0510MMS	MIAM10	ALCO PS2 A7A	200 RB 3	Temprite 900	A08-304	FSX-42U	1.022.024	1.957.004	2.258.036
U(N)J2192GK	SM2/30	ADK-0510MMS	MIAM10	ALCO PS2 A7A	200 RB 3	Temprite 900	A08-304	FSX-42U	1.022.024	1.957.004	2.258.036
U(N)J2192GS	SM2/30	ADK-0510MMS	MIAM10	ALCO PS2 A7A	200 RB 3	Temprite 900	A08-304	FSX-42U	1.022.024	1.957.004	-
U(N)J2212GK	SM2/30	ADK-0510MMS	MIAM10	ALCO PS2 A7A	200 RB 3	Temprite 900	A08-304	FSX-42U	1.022.024	1.957.004	2.258.036
U(N)J2212GS	SM2/30	ADK-0510MMS	MIAM10	ALCO PS2 A7A	200 RB 3	Temprite 900	A08-304	FSX-42U	1.022.024	1.957.004	-

**Notes:**

Accessories (drier, sight glass, pressure controls, suction accumulator, fan speed controller and solenoid valve) supplied by Alco.

Components from other suppliers are available upon request. Thermostat cable available upon request. AC Axial fan motor EBM upon request. Energy saving motor EBM on request.

## R 22 - LBP

MODEL	FILTER DRIER (1) TYPE	FILTER DRIER (2) TYPE	SIGHT GLASS TYPE	PRESSURE CONTROL TYPE	SOLENOID VALVE TYPE	OIL SEPARATOR TYPE	SUCTION ACCUMULATOR TYPE	FAN SPEED CONTROLLER TYPE	SCHRADER VALVE CODE	HOUSING CODE	POWER CORD CABLE CODE
UNE2125E	SM2/30	ADK-036MMS	MIAM06	ALCO PS2 A7A	110 RB 2	-	A08-304	-	1.022.024	1.957.003	2.258.064
UNE2134E	SM2/30	ADK-036MMS	MIAM06	ALCO PS2 A7A	110 RB 2	-	A08-304	-	1.022.024	1.957.003	2.258.064
UT2140E	SM2/30	ADK-036MMS	MIAM06	ALCO PS2 A7A	110 RB 2	Temprite 900	A08-304	FSX-42U	1.022.024	1.957.003	2.258.036
UT2155E	SM2/30	ADK-036MMS	MIAM06	ALCO PS2 A7A	110 RB 2	Temprite 900	A08-304	FSX-42U	1.022.024	1.957.003	2.258.036
UT2168E	SM2/30	ADK-036MMS	MIAM06	ALCO PS2 A7A	110 RB 2	Temprite 900	A08-304	FSX-42U	1.022.024	1.957.003	2.258.036
U(N)J2178E	SM2/30	ADK-0510MMS	MIAM10	ALCO PS2 A7A	200 RB 3	Temprite 900	A08-304	FSX-42U	1.022.024	1.957.004	2.258.036
U(N)J2190E	SM2/30	ADK-0510MMS	MIAM10	ALCO PS2 A7A	200 RB 3	Temprite 900	A08-304	FSX-42U	1.022.024	1.957.004	2.258.036

**Notes:**

Accessories (drier, sight glass, pressure controls, suction accumulator, fan speed controller and solenoid valve) supplied by Alco.

Components from other suppliers are available upon request. Thermostat cable available upon request. AC Axial fan motor EBM upon request. Energy saving motor EBM on request.

# R 134a - HBP

MODEL	FILTER DRIER (1) TYPE	FILTER DRIER (2) TYPE	SIGHT GLASS TYPE	PRESSURE CONTROL TYPE	SOLENOID VALVE TYPE	SUCTION ACCUMULATOR TYPE	FAN SPEED CONTROLLER TYPE	SCHRADER VALVE CODE	HOUSING CODE	POWER CORD CABLE CODE
UNB5125Z	SM2/30	-	-	-	-	-	-	1.022.024	1.957.003	2.258.064
UNB5128Z	SM2/30	-	-	-	-	-	-	1.022.024	1.957.003	2.258.064
UNB5132Z	SM2/30	-	-	-	-	-	-	1.022.024	1.957.003	2.258.064
UNB5144Z	SM2/30	-	-	-	-	-	-	1.022.024	1.957.003	2.258.064
UNE5160Z	SM2/30	-	-	-	-	-	-	1.022.024	1.957.003	2.258.064
UNE6160Z	SM2/30	ADK-036MMS	MIAM06	ALCO PS2 A7A	110 RB 2	A08-304	FSX-42U	1.022.024	1.957.003	2.258.064
UNE5170Z	SM2/30	-	-	-	-	-	-	1.022.024	1.957.003	2.258.064
UNE5187Z	SM2/30	-	-	-	-	-	-	1.022.024	1.957.003	2.258.064
UNE6170Z	SM2/30	ADK-036MMS	MIAM06	ALCO PS2 A7A	110 RB 2	A08-304	FSX-42U	1.022.024	1.957.003	2.258.064
UNE6187Z	SM2/30	ADK-036MMS	MIAM06	ALCO PS2 A7A	110 RB 2	A08-304	FSX-42U	1.022.024	1.957.003	2.258.064
UNE6210Z	SM2/30	ADK-036MMS	MIAM06	ALCO PS2 A7A	110 RB 2	A08-304	FSX-42U	1.022.024	1.957.003	2.258.064
UNB6144Z	SM2/30	ADK-036MMS	MIAM06	ALCO PS2 A7A	110 RB 2	A08-304	FSX-42U	1.022.024	1.957.003	2.258.064
UNEK6160Z	SM2/30	ADK-036MMS	MIAM06	ALCO PS2 A7A	110 RB 2	A08-304	FSX-42U	1.022.024	1.957.003	2.258.064
UNEK6170Z	SM2/30	ADK-036MMS	MIAM06	ALCO PS2 A7A	110 RB 2	A08-304	FSX-42U	1.022.024	1.957.003	2.258.064
UNEK6187Z	SM2/30	ADK-036MMS	MIAM06	ALCO PS2 A7A	110 RB 2	A08-304	FSX-42U	1.022.024	1.957.003	2.258.064
UNEK6210Z	SM2/30	ADK-036MMS	MIAM06	ALCO PS2 A7A	110 RB 2	A08-304	FSX-42U	1.022.024	1.957.003	2.258.064
UNEK6212Z	SM2/30	ADK-036MMS	MIAM06	ALCO PS2 A7A	110 RB 2	A08-304	FSX-42U	1.022.024	1.957.003	2.258.064
UNEK6214Z	SM2/30	ADK-0510MMS	MIAM10	ALCO PS2 A7A	200 RB 3	A08-304	FSX-42U	1.022.024	1.957.003	2.258.036
UT5213Z	SM2/30	-	-	-	-	-	-	1.022.024	1.957.003	2.258.036
UT6213Z	SM2/30	ADK-0510MMS	MIAM10	ALCO PS2 A7A	200 RB 3	A08-304	FSX-42U	1.022.024	1.957.003	2.258.036
UT6215Z	SM2/30	ADK-0510MMS	MIAM10	ALCO PS2 A7A	200 RB 3	A08-304	FSX-42U	1.022.024	1.957.003	2.258.036
U(N)J6220Z	SM2/30	ADK-0510MMS	MIAM10	ALCO PS2 A7A	200 RB 3	A08-304	FSX-42U	1.022.024	1.957.004	2.258.036
U(N)J6220ZX	SM2/30	ADK-0510MMS	MIAM10	ALCO PS2 A7A	200 RB 3	A08-304	FSX-42U	1.022.024	1.957.004	-
U(N)J6226Z	SM2/30	ADK-0510MMS	MIAM10	ALCO PS2 A7A	200 RB 3	A08-304	FSX-42U	1.022.024	1.957.004	2.258.036
U(N)J6226ZX	SM2/30	ADK-0510MMS	MIAM10	ALCO PS2 A7A	200 RB 3	A08-304	FSX-42U	1.022.024	1.957.004	-

**Notes:**

Accessories (drier, sight glass, pressure controls, suction accumulator, fan speed controller and solenoid valve) supplied by Alco.

Components from other suppliers are available upon request. Thermostat cable available upon request. AC Axial fan motor EBM upon request. Energy saving motor EBM on request.

# R 22 - M/HBP

MODEL	FILTER DRIER (1) TYPE	FILTER DRIER (2) TYPE	SIGHT GLASS TYPE	PRESSURE CONTROL TYPE	SOLENOID VALVE TYPE	SUCTION ACCUMULATOR TYPE	FAN SPEED CONTROLLER TYPE	SCHRADER VALVE CODE	HOUSING CODE	POWER CORD CABLE CODE
UNB6144E	SM2/30	ADK-036MMS	MIAM06	ALCO PS2 A7A	110 RB 2	A08-304	FSX-42U	1.022.024	1.957.003	2.258.064
UNB6152E	SM2/30	ADK-036MMS	MIAM06	ALCO PS2 A7A	110 RB 2	A08-304	FSX-42U	1.022.024	1.957.003	2.258.064
UNB6165E	SM2/30	ADK-036MMS	MIAM06	ALCO PS2 A7A	110 RB 2	A08-304	FSX-42U	1.022.024	1.957.003	2.258.064
UNE6181E	SM2/30	ADK-036MMS	MIAM06	ALCO PS2 A7A	110 RB 2	A08-304	FSX-42U	1.022.024	1.957.003	2.258.064
UNE6195E	SM2/30	ADK-036MMS	MIAM06	ALCO PS2 A7A	110 RB 2	A08-304	FSX-42U	1.022.024	1.957.003	2.258.064
UNE6210E	SM2/30	ADK-036MMS	MIAM06	ALCO PS2 A7A	110 RB 2	A08-304	FSX-42U	1.022.024	1.957.003	2.258.064
UNE9213E	SM2/30	ADK-036MMS	MIAM06	ALCO PS2 A7A	110 RB 2	A08-304	FSX-42U	1.022.024	1.957.003	2.258.036
UT6217E	SM2/30	ADK-0510MMS	MIAM10	ALCO PS2 A7A	200 RB 3	A08-304	FSX-42U	1.022.024	1.957.004	2.258.036
UT6220E	SM2/30	ADK-0510MMS	MIAM10	ALCO PS2 A7A	200 RB 3	A08-304	FSX-42U	1.022.024	1.957.004	2.258.036
UT6222E	SM2/30	ADK-0510MMS	MIAM10	ALCO PS2 A7A	200 RB 3	A08-304	FSX-42U	1.022.024	1.957.004	2.258.036
U(N)J9226E	SM2/30	ADK-0510MMS	MIAM10	ALCO PS2 A7A	200 RB 3	A08-304	FSX-42U	1.022.024	1.957.004	2.258.036
U(N)J9226P	SM2/30	ADK-0510MMS	MIAM10	ALCO PS2 A7A	200 RB 3	A08-304	FSX-42U	1.022.024	1.957.004	-
U(N)J7228F	SM2/30	ADK-0510MMS	MIAM10	ALCO PS2 A7A	200 RB 3	A08-304	FSX-42U	1.022.024	1.957.004	2.258.036
UJ7228P	SM2/30	ADK-0510MMS	MIAM10	ALCO PS2 A7A	200 RB 3	A08-304	FSX-42U	1.022.024	1.957.004	-
U(N)J7231F	SM2/30	ADK-0510MMS	MIAM10	ALCO PS2 A7A	200 RB 3	A08-304	FSX-42U	1.022.024	1.957.004	2.258.036
U(N)J7231P	SM2/30	ADK-0510MMS	MIAM10	ALCO PS2 A7A	200 RB 3	A08-304	FSX-42U	1.022.024	1.957.004	-
U(N)J9232E	SM2/30	ADK-0510MMS	MIAM10	ALCO PS2 A7A	200 RB 3	A08-304	FSX-42U	1.022.024	1.957.004	2.258.036
U(N)J9232P	SM2/30	ADK-0510MMS	MIAM10	ALCO PS2 A7A	200 RB 3	A08-304	FSX-42U	1.022.024	1.957.004	-
U(N)J9238E	SM2/30	ADK-0510MMS	MIAM10	ALCO PS2 A7A	200 RB 3	A08-304	FSX-42U	1.022.024	1.957.004	2.258.036
U(N)J9238P	SM2/30	ADK-0510MMS	MIAM10	ALCO PS2 A7A	200 RB 3	A08-304	FSX-42U	1.022.024	1.957.004	-
U(N)J7240P	SM2/30	ADK-0510MMS	MIAM10	ALCO PS2 A7A	200 RB 3	A08-304	FSX-42U	1.022.024	1.957.004	-
U(N)J7240F	SM2/30	ADK-0510MMS	MIAM10	ALCO PS2 A7A	200 RB 3	A08-304	FSX-42U	1.022.024	1.957.004	2.258.036

**Notes:**

Accessories (drier, sight glass, pressure controls, suction accumulator, fan speed controller and solenoid valve) supplied by Alco.

Components from other suppliers are available upon request. Thermostat cable available upon request. AC Axial fan motor EBM upon request. Energy saving motor EBM on request.

# AVAILABLE ACCESSORIES

## R 404A / R 507 - MBP

MODEL	FILTER DRIER (1) TYPE	FILTER DRIER (2) TYPE	SIGHT GLASS TYPE	PRESSURE CONTROL TYPE	SOLENOID VALVE TYPE	SUCTION ACCUMULATOR TYPE	FAN SPEED CONTROLLER TYPE	SCHRADER VALVE CODE	HOUSING CODE	POWER CORD CABLE CODE
UNB6144GK	SM2/30	ADK-036MMS	MIAM06	ALCO PS2 A7A	110 RB 2	A08-304	FSX-42U	1.022.024	1.957.003	2.258.064
UNB6152GK	SM2/30	ADK-036MMS	MIAM06	ALCO PS2 A7A	110 RB 2	A08-304	FSX-42U	1.022.024	1.957.003	2.258.064
UNB6165GK	SM2/30	ADK-036MMS	MIAM06	ALCO PS2 A7A	110 RB 2	A08-304	FSX-42U	1.022.024	1.957.003	2.258.064
UNEK6144GK	SM2/30	ADK-036MMS	MIAM06	ALCO PS2 A7A	110 RB 2	A08-304	FSX-42U	1.022.024	1.957.003	2.258.064
UNEK6165GK	SM2/30	ADK-036MMS	MIAM06	ALCO PS2 A7A	110 RB 2	A08-304	FSX-42U	1.022.024	1.957.003	2.258.064
UNE6181GK	SM2/30	ADK-036MMS	MIAM06	ALCO PS2 A7A	110 RB 2	A08-304	FSX-42U	1.022.024	1.957.003	2.258.064
UNEK6181GK	SM2/30	ADK-036MMS	MIAM06	ALCO PS2 A7A	110 RB 2	A08-304	FSX-42U	1.022.024	1.957.003	2.258.064
UNE6195GK	SM2/30	ADK-036MMS	MIAM06	ALCO PS2 A7A	110 RB 2	A08-304	FSX-42U	1.022.024	1.957.003	2.258.064
UNE6210GK	SM2/30	ADK-036MMS	MIAM06	ALCO PS2 A7A	110 RB 2	A08-304	FSX-42U	1.022.024	1.957.003	2.258.064
UNEK6210GK	SM2/31	ADK-036MMS	MIAM07	ALCO PS2 A7A	111 RB 2	A08-305	FSX-42U	1.022.024	1.957.003	2.258.064
UNEK6213GK	SM2/30	ADK-036MMS	MIAM06	ALCO PS2 A7A	110 RB 2	A08-304	FSX-42U	1.022.024	1.957.003	2.258.064
UNEK6217GK	SM2/30	ADK-0510MMS	MIAM10	ALCO PS2 A7A	200 RB 3	A08-304	FSX-42U	1.022.024	1.957.004	2.258.036
UNE9213GK	SM2/30	ADK-036MMS	MIAM06	ALCO PS2 A7A	110 RB 2	A08-304	FSX-42U	1.022.024	1.957.003	2.258.036
UT6217GK	SM2/30	ADK-0510MMS	MIAM10	ALCO PS2 A7A	200 RB 3	A08-304	FSX-42U	1.022.024	1.957.004	2.258.036
UT6220GK	SM2/30	ADK-0510MMS	MIAM10	ALCO PS2 A7A	200 RB 3	A08-304	FSX-42U	1.022.024	1.957.004	2.258.036
UT6222GK	SM2/30	ADK-0510MMS	MIAM10	ALCO PS2 A7A	200 RB 3	A08-304	FSX-42U	1.022.024	1.957.004	2.258.036
U(N)J9226GK	SM2/30	ADK-0510MMS	MIAM10	ALCO PS2 A7A	200 RB 3	A08-304	FSX-42U	1.022.024	1.957.004	2.258.036
U(N)J9226GS	SM2/30	ADK-0510MMS	MIAM10	ALCO PS2 A7A	200 RB 3	A08-304	FSX-42U	1.022.024	1.957.004	-
U(N)J9232GK	SM2/30	ADK-0510MMS	MIAM10	ALCO PS2 A7A	200 RB 3	A08-304	FSX-42U	1.022.024	1.957.004	2.258.036
U(N)J9232GS	SM2/30	ADK-0510MMS	MIAM10	ALCO PS2 A7A	200 RB 3	A08-304	FSX-42U	1.022.024	1.957.004	-
U(N)J9238GK	SM2/30	ADK-0510MMS	MIAM10	ALCO PS2 A7A	200 RB 3	A08-304	FSX-42U	1.022.024	1.957.004	2.258.036
U(N)J9238GS	SM2/30	ADK-0510MMS	MIAM10	ALCO PS2 A7A	200 RB 3	A08-304	FSX-42U	1.022.024	1.957.004	-

Notes:  
 Accessories (drier, sight glass, pressure controls, suction accumulator, fan speed controller and solenoid valve) supplied by Alco.  
 Components from other suppliers are available upon request. Thermostat cable available upon request. AC Axial fan motor EBM upon request. Energy saving motor EBM on request.

## EXTERNAL VIEWS - With Accessories and Special Versions\* (Examples)

### UNT Serie

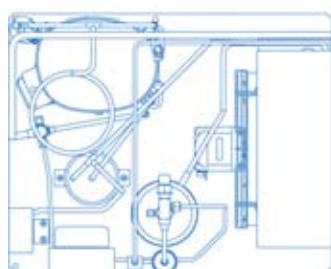
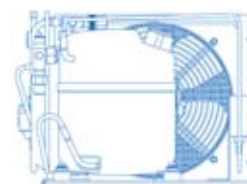
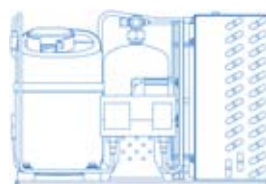
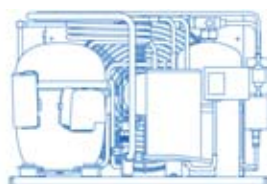
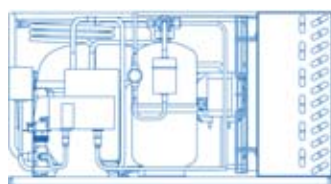

### UNJ Serie

\* Those versions are customized and created on request of customer.

# EXTERNAL VIEWS - With Accessories and Special Versions\* (Examples)

## UNE Serie

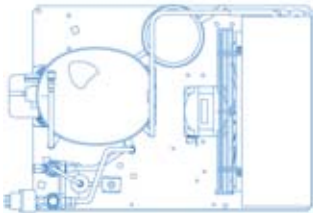
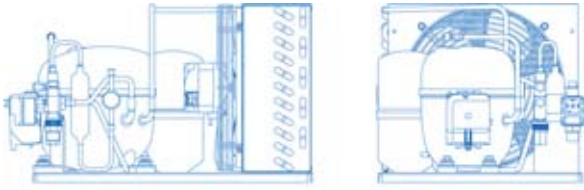

## UT Serie

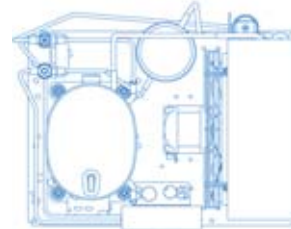
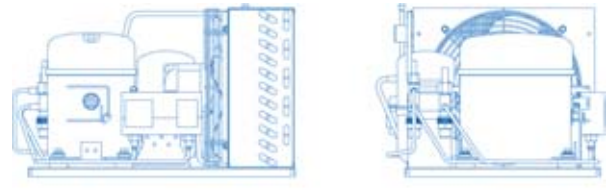

## Special Units

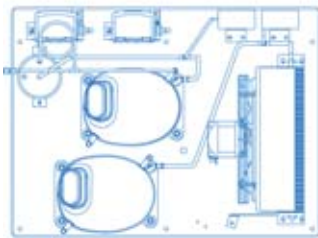

\* Those versions are customized and created on request of customer.

# EXTERNAL VIEWS - Standard Versions

## 1.955.160

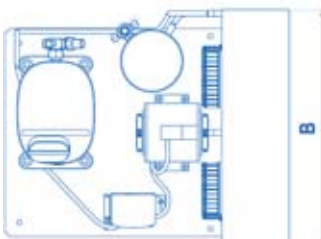
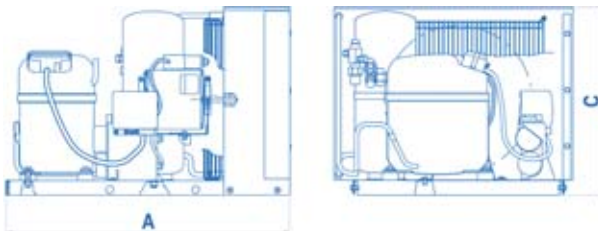

## 1.955.183

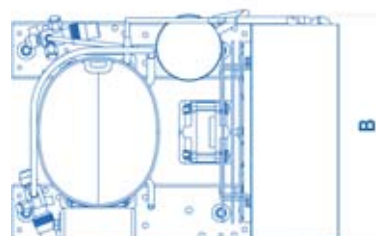
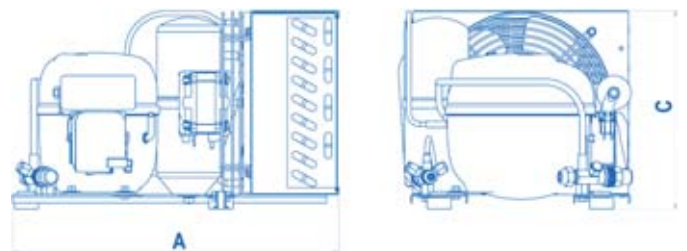

# EXTERNAL VIEWS - Standard Versions

1.955.184

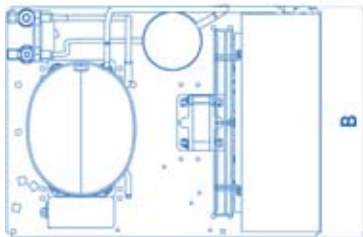
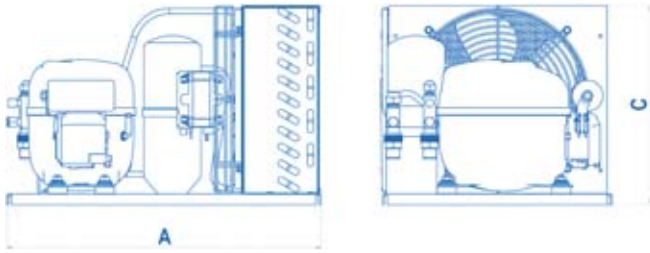

1.955.185

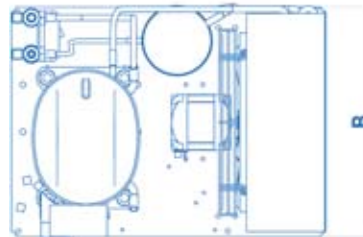
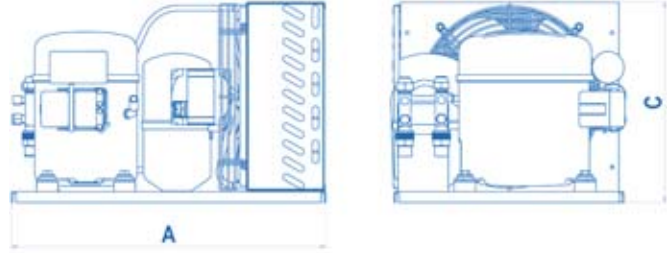

1.955.186

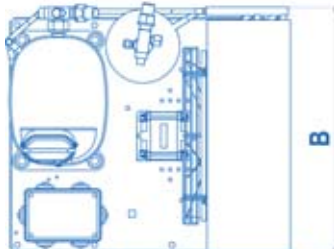
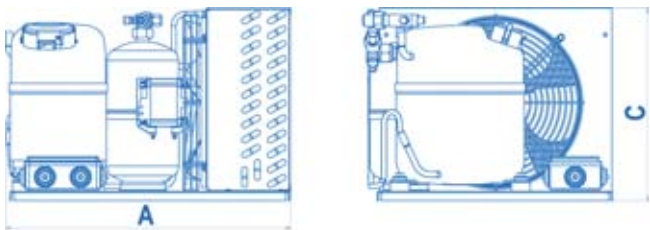

1.955.190

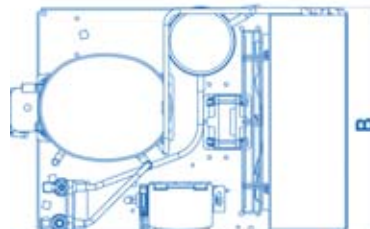
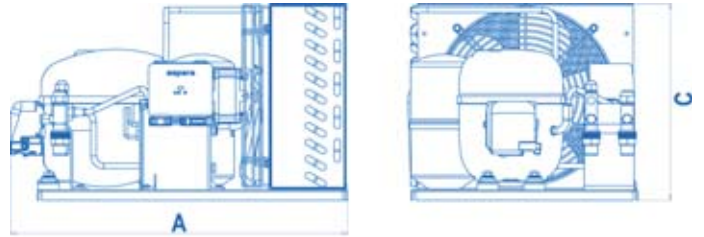

1.955.191

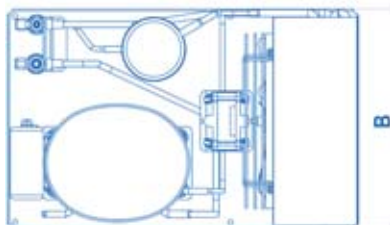
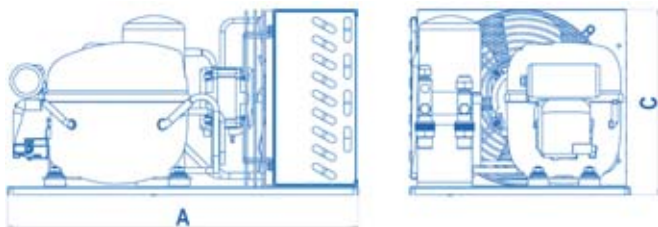

1.955.192

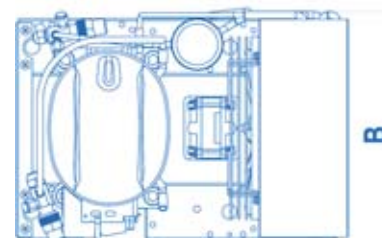
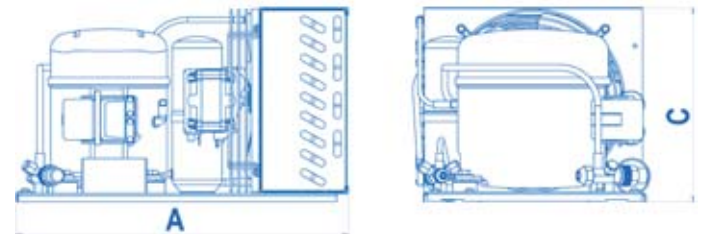

# EXTERNAL VIEWS - Standard Versions

**1.955.193**

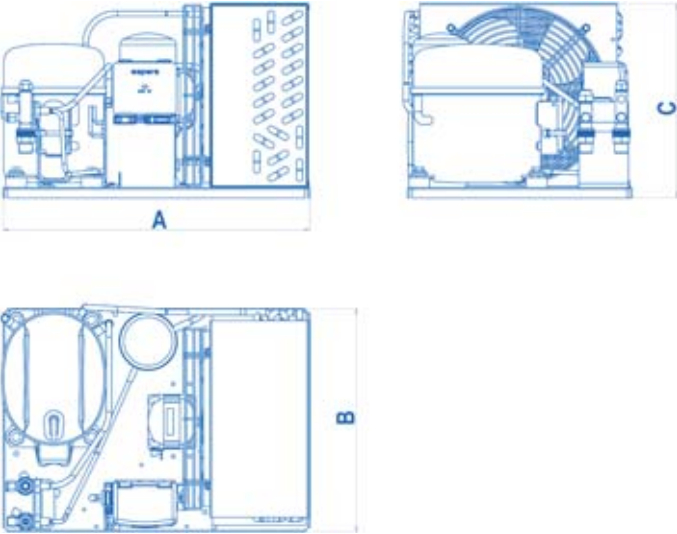

**1.955.194**

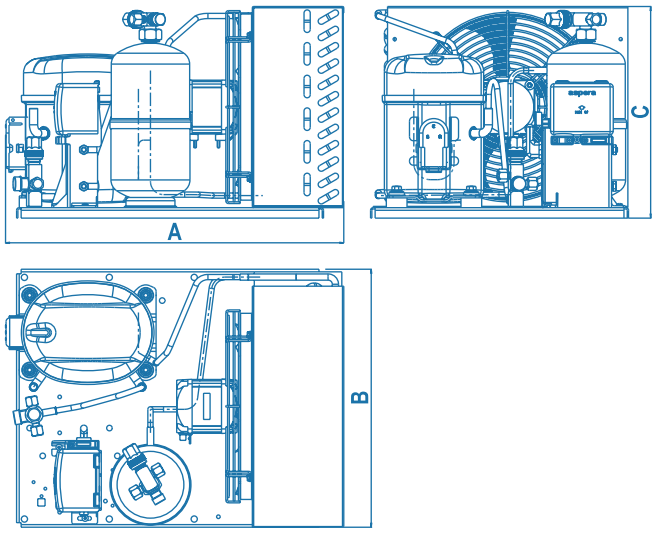

**1.955.195**

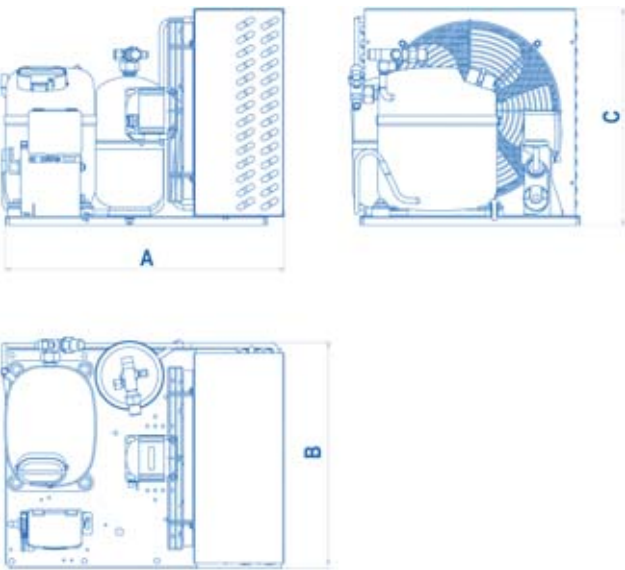

**1.955.196**

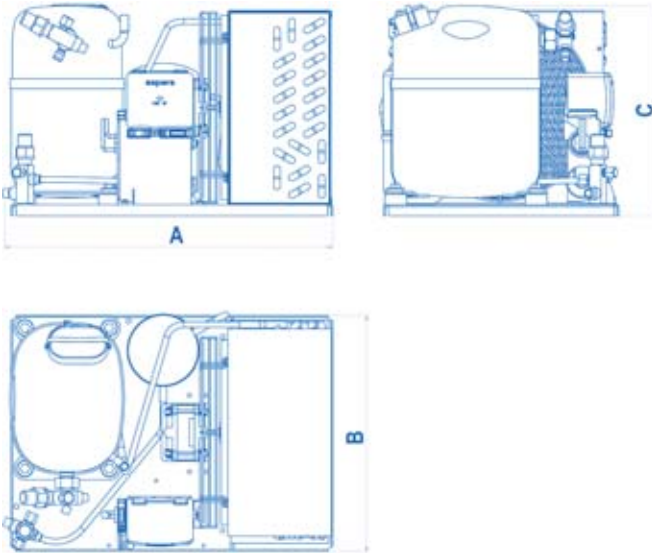

**1.955.381**

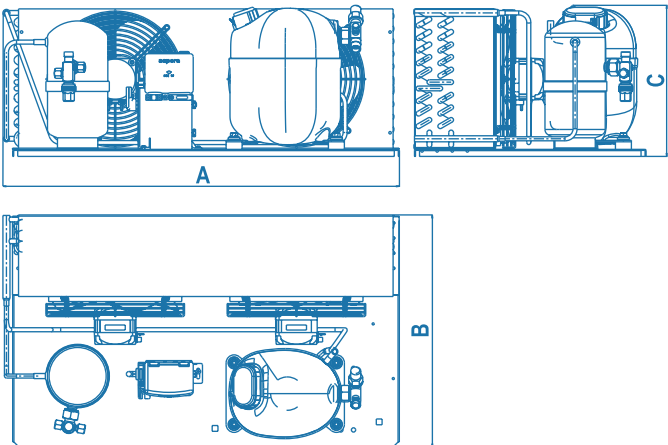

# WIRING DIAGRAMS

## RSIR Electrical Hookup UT - UNE - UNB

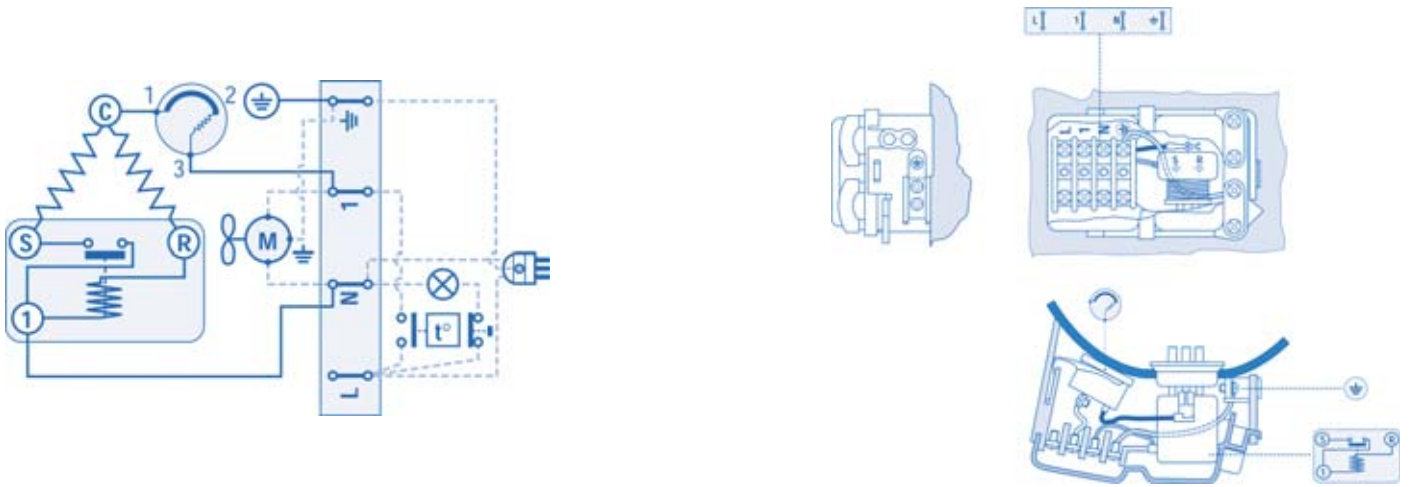

## CSIR Electrical Hookup UT - UNE - UNB

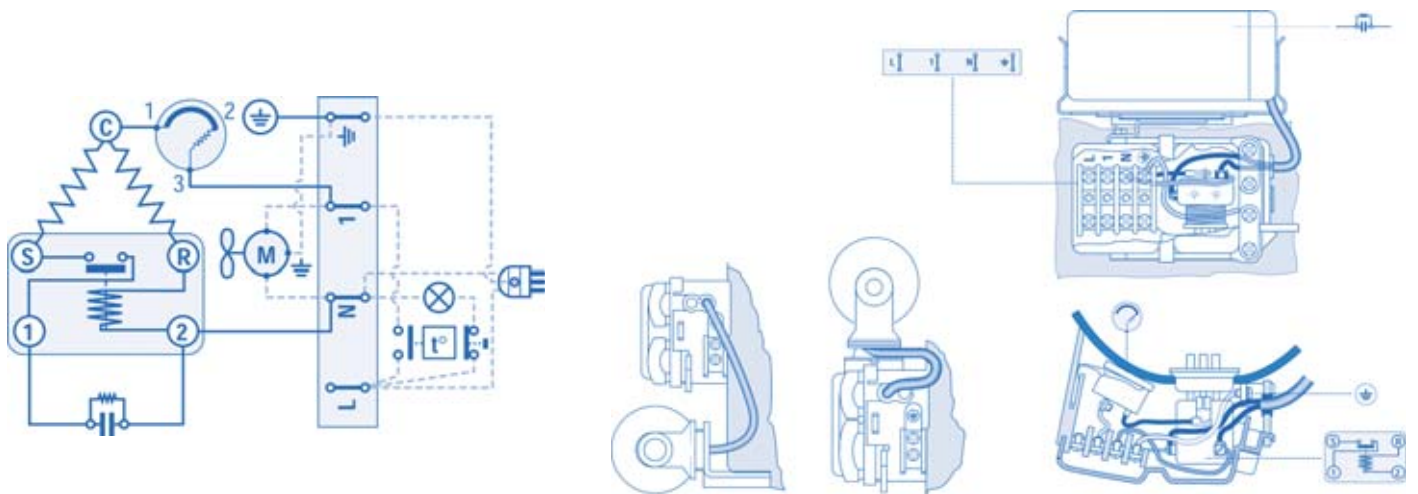

## CSR Electrical Hookup UJ - UT - UNE

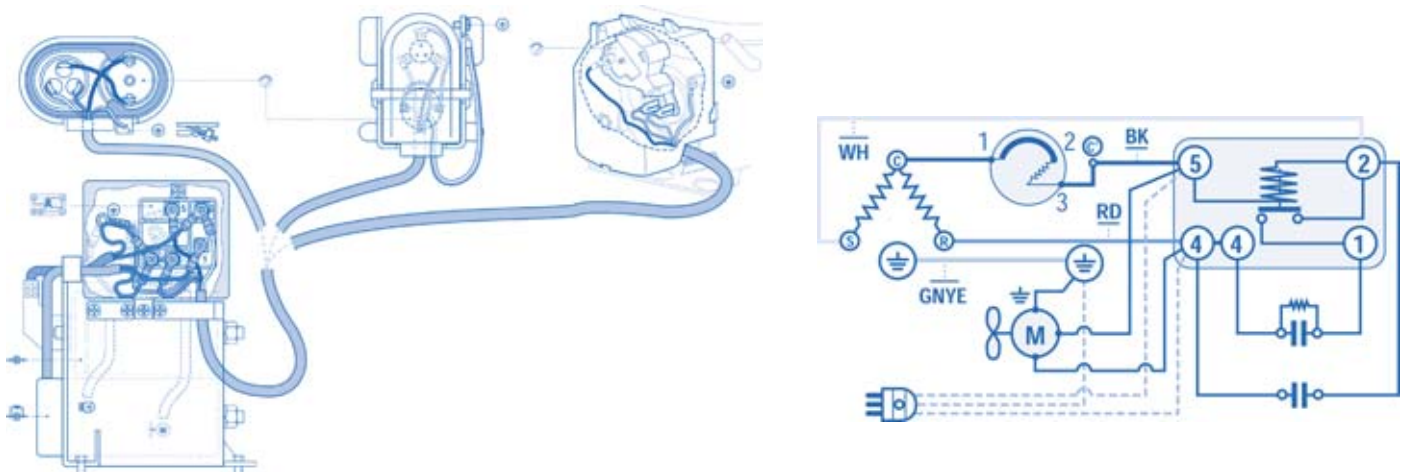

# WIRING DIAGRAMS

## RSIR Electrical Hookup UNE - UNB

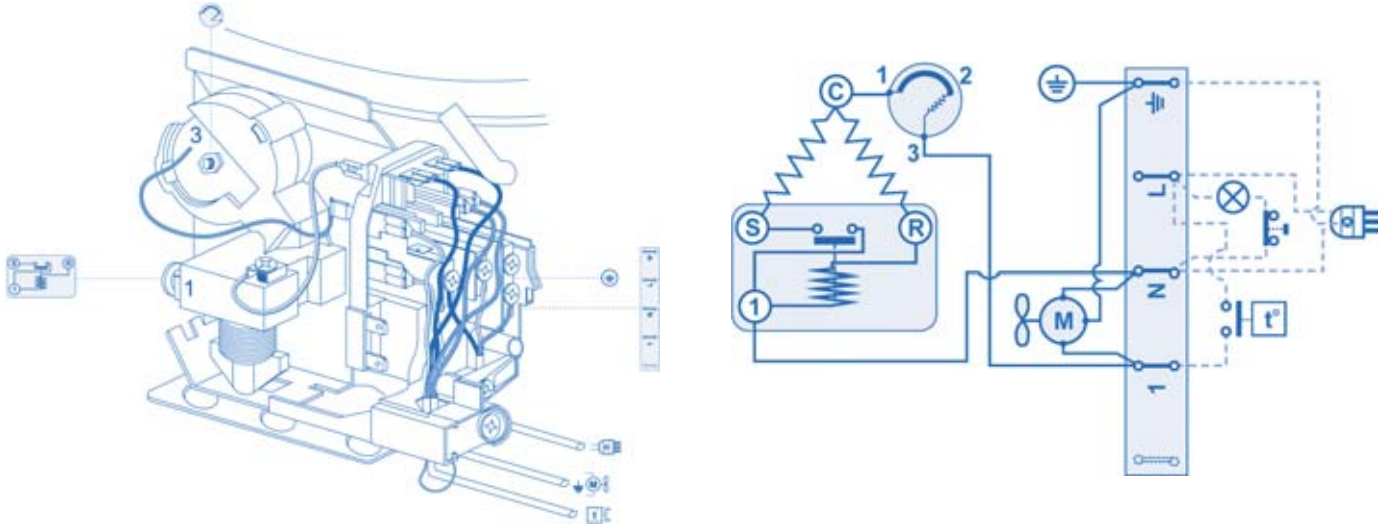

## CSIR Electrical Hookup UNE - UNB

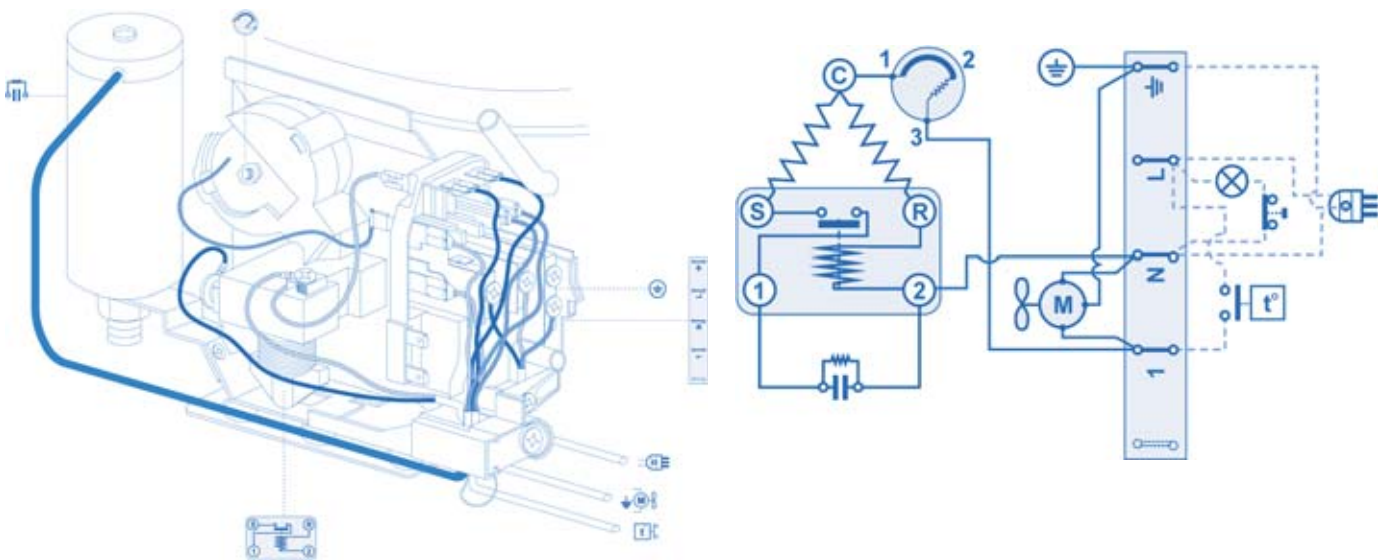

# WIRING DIAGRAMS



## 3 PHASE Electrical Hookup UJ

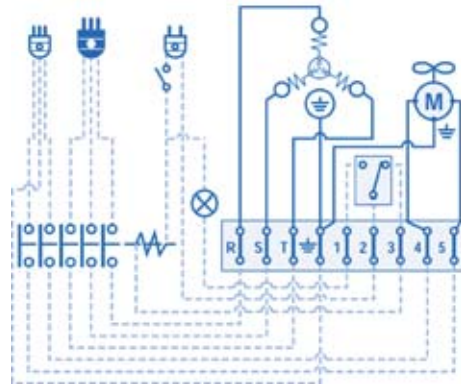
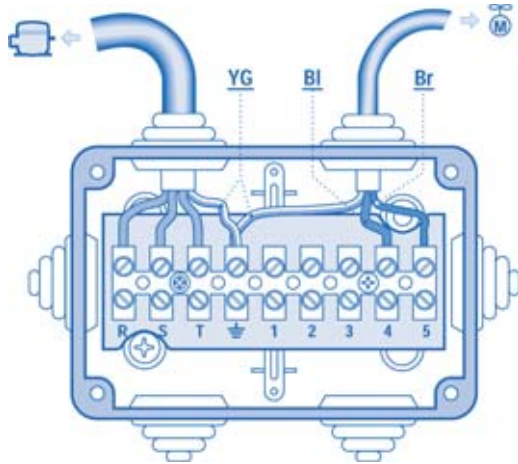

## CSIR Electrical Hookup UJ

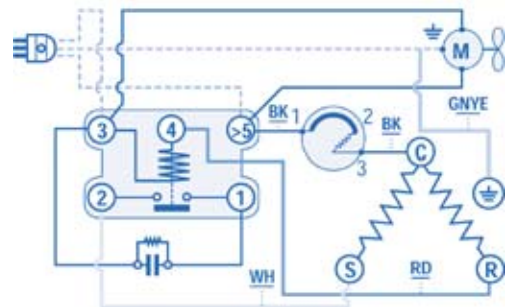
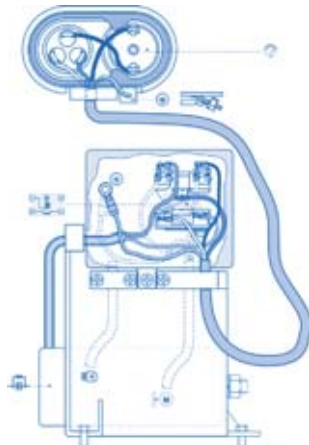

## LEGEND

<b>C</b> Common	<b>R</b> Run	<b>WH</b> White	<b>RD</b> Red
<b>S</b> Start	<b>C'</b> Common (internal overload protection)	<b>GNYE</b> Green - Yellow	<b>BL</b> Blue
		<b>BK</b> Black	<b>BR</b> Brown
Overload protector	Start relay	Start capacitor	Run capacitor
Fan motor	Thermostat	Earth connection	Terminal box
Lamp	Switch	High / Low pressure switch	

# ROTALOCK VALVES

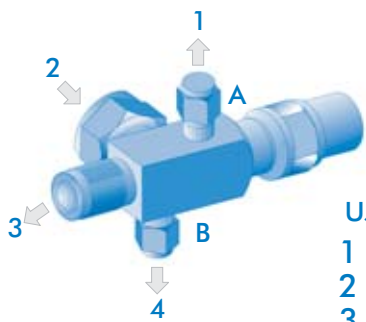

## UJ VALVES

- 1 Process and manometer
- 2 Connection to compressor or receiver
- 3 Main connection
- 4 Pressostat port

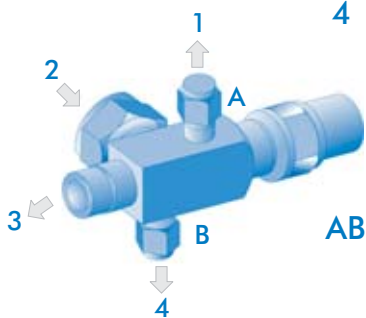

**AB** Hexagonal blind nuts  
(tightening torque 10.8 - 16.3 Nm)

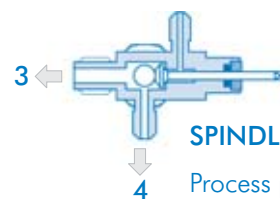

### SPINDLE BACK POSITION

Process port closed

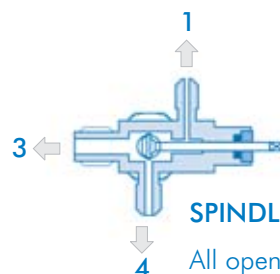

### SPINDLE MIDDLE POSITION

All open

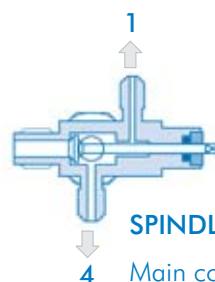

### SPINDLE FRONT POSITION

Main connection closed

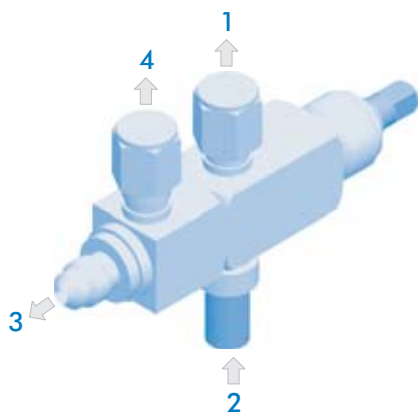

## VALVES FIXED ON BRACKET

- 1 Pressostat connection (always open)
- 2 Connection to compressor or receiver
- 3 Main connection
- 4 Process and manometer closed with schrader valve

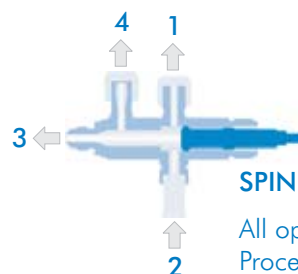

### SPINDLE BACK POSITION

All open  
Process port closed by schrader

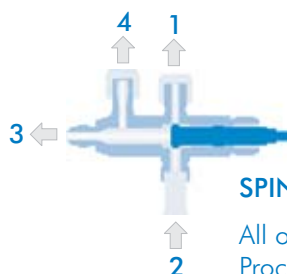

### SPINDLE MIDDLE POSITION

All open  
Process port closed by schrader

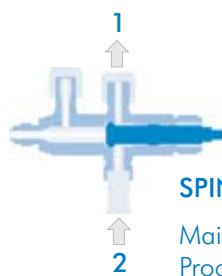

### SPINDLE FRONT POSITION

Main connection closed  
Process port closed by schrader

## RECOMMENDED TORQUE FOR ALL TYPES OF VALVES

VALVE NOMINAL DIMENSION (SAE)	SPINDLE TORQUE (Nm)
1/4"	8.5 - 13.5
3/8"	8.5 - 13.5
1/2"	8.5 - 13.5
5/8"	8.5 - 13.5

# NOMENCLATURE

## CONDENSING UNIT MODEL

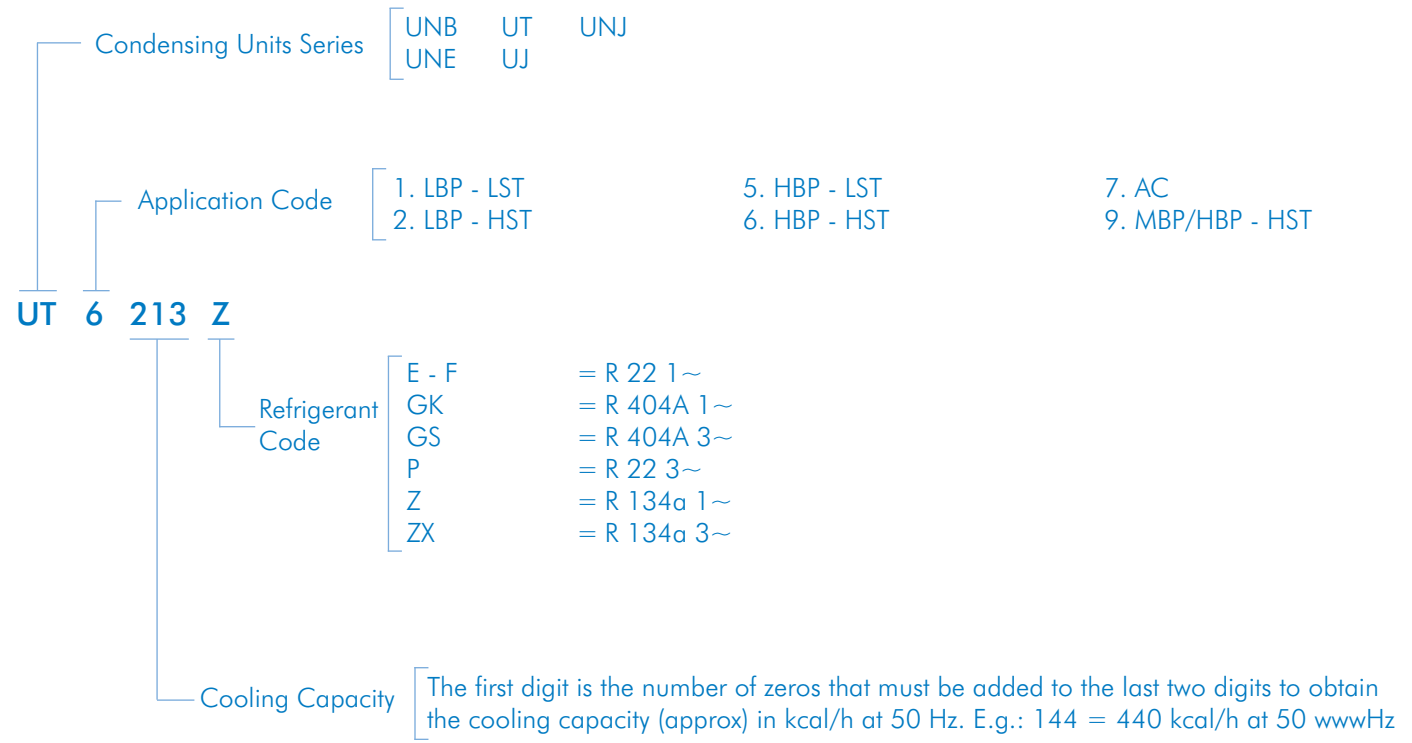

## BILL OF MATERIAL (B.O.M.)

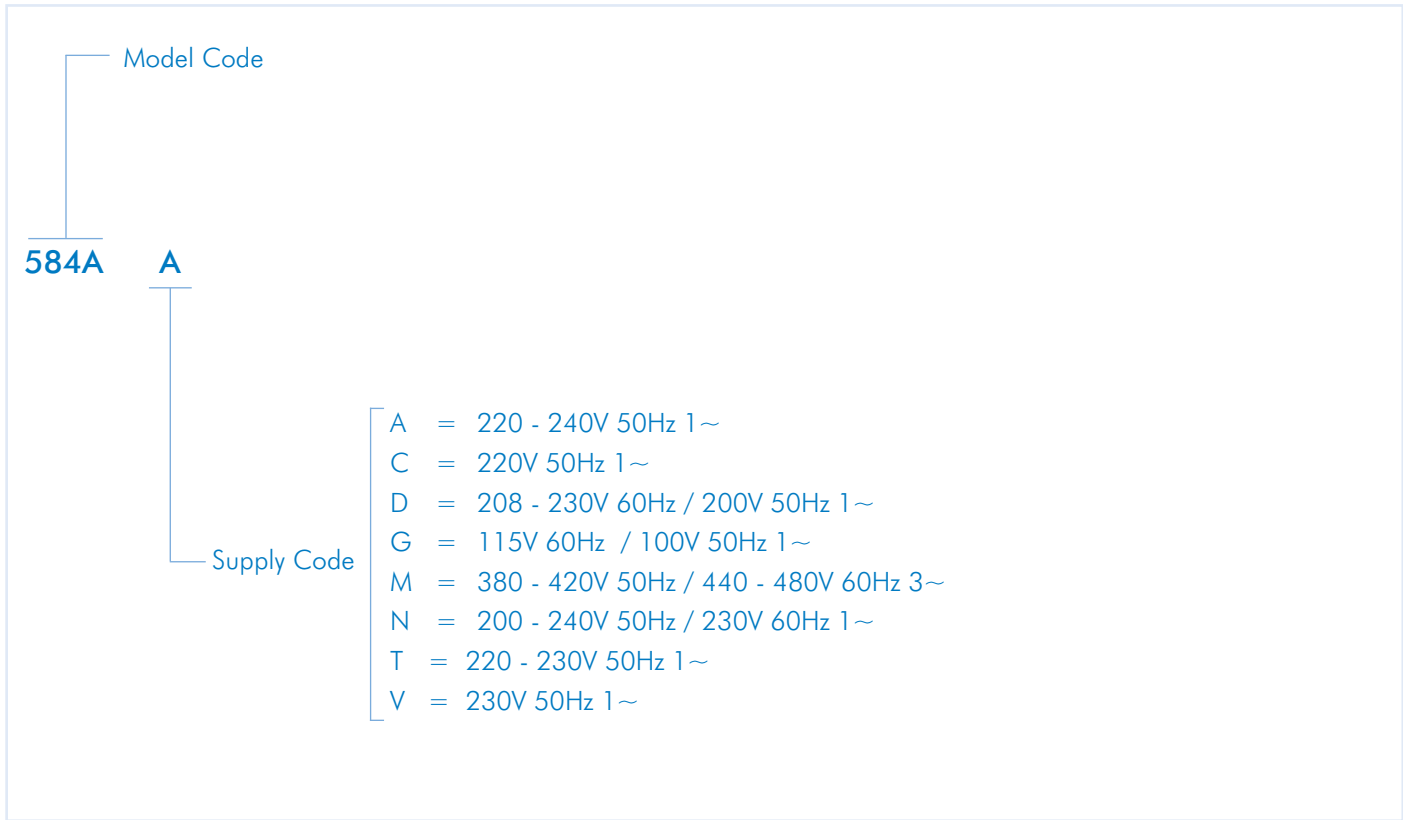



Brazil

Rui Barbosa, 1020 - P.O. BOX 91  
89219-901 - Joinville - SC - Brazil  
Phone: +55 47 3441-2121  
Fax: +55 47 3441-2780



Italy

Via Buttigliera 6  
10020 - Riva Presso Chieri (Torino) - Italy  
P.O. BOX 151 - 10023 Chieri (TO)  
Phone: +39 011 943-7111  
Fax: +39 011 946-8377  
+39 011 946-9950



Slovakia

Odorinska Cesta, 2 - 052-01  
Spišská Nová Ves - Slovakia  
Phone: +42 153 417-2291  
+42 153 417-2293  
Fax: +42 153 417-2299

Europe - Sales Office  
Zona Industriale D1 - Via Fratelli Gambino, 7  
10023 - Chieri (Torino) - Italy  
Phone: +39 011 940-5611  
Fax: +39 011 940-5656



U.S.A.

2800 Vista Ridge Drive NE  
Suwanee, GA 30024-3510  
Phone: +1 678 804 1337  
Fax: +1 678 804 1338

México - Sales Office  
Torre Alestra, Piso 3 - Office 321  
Av. Lázaro Cárdenas 2321 Pte.  
P.O. BOX 66260 - San Pedro Garza García  
Nuevo León - México  
Phone: +52 81 1001-7102  
Fax: +52 81 1001-7142



China

29 Yuhua Road  
Area B of Beijing Tianzhu Airport Industrial Zone  
101312 - Beijing - China  
Phone: +86 10 8048-2255  
Fax: +86 10 6725-6825

[www.embraco.com](http://www.embraco.com)

 **Embraco** aspera



Embraco is participating in the United Nations Global Compact.