



Strip Heaters

Ceramic Insulated



U.L. Recognized-E56973 C.S.A. Certified – 016386-0-000

Applications

Dies, Molds, Plastic Forming and Sealing. Tank and Kettle Heating. For specific applications, correctly rated elements should be used to prevent overheating and to ensure long life. A guide to correct watt densities for specific applications is shown on the next page.

Features

- The Hotwatt Stainless Steel Strip Heater provides clean, dependable heat with sheath temperatures up to 1200°F (649°C) and watt densities up to 40 watts per square inch.
- Because of the seamless stainless steel sheath, Hotwatt Ceramic Insulated Strip Heaters are dimensionally stable in milled slots.
- Made in U.S.A.

Construction

- 1 Seamless stainless steel sheath.
- 2 Post terminals.
- 3 Ceramic element support.
- 4 Element wire situated in close proximity to outside surface for maximum heat transfer and minimum internal temperature while preserving good dielectric qualities.
- 5 Magnesium oxide packing.

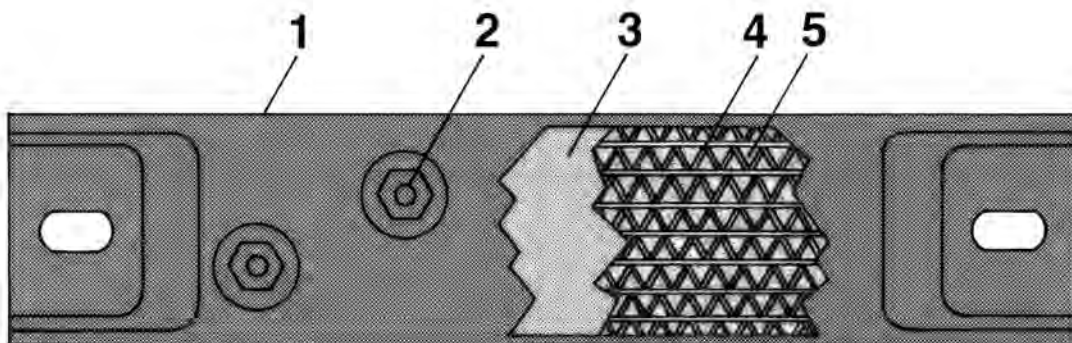



Strip Heaters

Ceramic Insulated

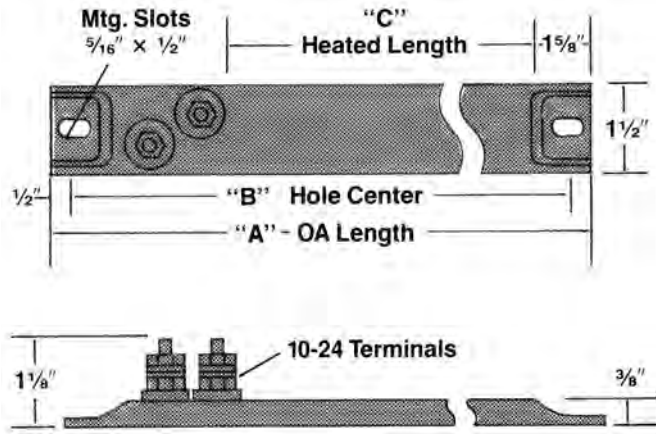

Standard Termination

Type OF: Offset at one end.

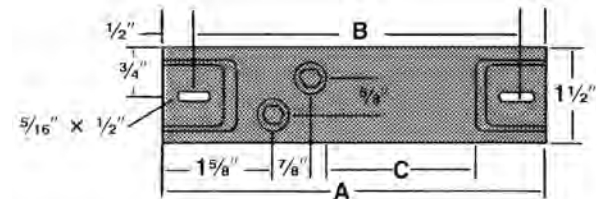

▼ **Manufactured Items** ▼

Cat.No.	"A"	"B"	"C"	Min. Watts	Max. Watts
CS-5.5	5 1/2"	4 1/2"	1"	50	180
CS-7.5	7 1/2"	6 1/2"	3"	50	360
CS-8	8"	7"	2 3/4"	50	430
CS-9.5	9 1/2"	8 1/2"	4 1/4"	50	510
CS-10.5	10 1/2"	9 1/2"	5 1/4"	50	630
CS-12	12"	11"	7 1/4"	50	810
CS-14	14"	13"	9 1/4"	50	1050
CS-15.2	15 1/4"	14 1/4"	10"	50	1200
CS-16.2	16 1/4"	15 1/4"	11"	50	1320
CS-18	18"	17"	12 3/4"	50	1530
CS-19.5	19 1/2"	18 1/2"	14 1/4"	50	1710
CS-21	21"	20"	15 3/4"	50	1890
CS-23.7	23 3/4"	22 3/4"	18 1/2"	50	2220
CS-25.5	25 1/2"	24 1/2"	20 1/4"	50	2430
CS-26.7	26 3/4"	25 3/4"	21 1/2"	50	2580
CS-28.2	28 1/4"	27 1/4"	23"	75	2760
CS-30	30"	29"	24 3/4"	75	2970
CS-30.5	30 1/2"	29 1/2"	25 1/4"	75	3030
CS-33.5	33 1/2"	32 1/2"	28 1/4"	75	3390
CS-35.7	35 3/4"	34 3/4"	30 1/2"	75	3660
CS-38.5	38 1/2"	37 1/2"	33 3/4"	100	3990
CS-42.5	42 1/2"	41 1/2"	37 1/4"	100	4320
CS-47.7	47 3/4"	46 3/4"	42 1/2"	100	4320
CS-50.5	50 1/2"	49 1/4"	45 1/4"	100	4320
CS-53.7	53 3/4"	52 3/4"	48 1/2"	100	4320
CS-63.7	63 3/4"	62 3/4"	50 1/2"	100	4320

- Maximum wattage limited by 18 amp maximum at 240 volts for catalog numbers CS-42.5 and longer. Any wattage is available between minimum and maximum without effecting price.
- Unit lengths between and longer than those listed may be ordered.
- Standard termination is Type OF. Units under 8" long, standard termination is SSA.

Application	Max. Watts/sq. in.
Platen heating	
Up to 300°F (149°C)	40
300° - 600°F (149°C-316°C)	20
600° - 800°F (316°C-427°C)	15

Formulas for Determination of Watt Density

$$\text{Watts/sq in} = \frac{\text{Total unit wattage}}{\text{C (heated length)} \times 3}$$

Optional Terminations

See page 61.



Strip Heaters

Ceramic Insulated

▼ IN STOCK ITEMS ▼

Strip Heaters – Stainless steel sheath

Supplied with: Type OF terminals, except CS-5.5, which is SSA
U.L. Recognized — E56973

C.S.A. Certified – 016386-0-000

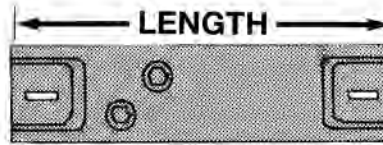

STRIP

Length	Cat. No.	Wattage	Voltage	Watts/in ²	Weight	Mounting Hole Center
5½"	CS5.5	40	120	12	.37	4½"
5½"	CS5.5	150	120	50	.37	4½"
5½"	CS5.5	150	240	50	.37	4½"
8"	CS8	60	120	7	.56	7"
8"	CS8	80	120	10	.56	7"
8"	CS8	250	120	30	.56	7"
8"	CS8	250	240	30	.56	7"
8"	CS8	330	120	40	.56	7"
8"	CS8	330	240	40	.56	7"
10½"	CS10.5	75	120	5	.69	9½"
10½"	CS10.5	300	120	19	.69	9½"
10½"	CS10.5	300	240	19	.69	9½"
12"	CS12	125	120	6	.81	11"
12"	CS12	190	120	9	.81	11"
12"	CS12	500	120	25	.81	11"
12"	CS12	500	240	25	.81	11"
12"	CS12	750	120	37	.81	11"
12"	CS12	750	240	37	.81	11"
15¼"	CS15.2	125	120	4	1.12	14¼"
15¼"	CS15.2	500	120	16	1.12	14¼"
15¼"	CS15.2	500	240	16	1.12	14¼"
18"	CS18	190	120	5	1.37	17"
18"	CS18	310	120	8	1.37	17"
18"	CS18	750	120	20	1.37	17"
18"	CS18	750	240	20	1.37	17"
18"	CS18	1250	120	32	1.37	17"
18"	CS18	1250	240	32	1.37	17"
23¾"	CS23.7	250	120	4	1.69	22¾"
23¾"	CS23.7	450	120	8	1.69	22¾"
23¾"	CS23.7	1000	120	18	1.69	22¾"
23¾"	CS23.7	1000	240	18	1.69	22¾"
23¾"	CS23.7	1800	240	32	1.69	22¾"
30"	CS30	500	120	7	2.35	29"
30"	CS30	2000	240	27	2.35	29"
35¾"	CS35.7	625	120	7	2.43	34¾"
35¾"	CS35.7	2500	240	27	2.43	34¾"



Strip Heaters

Ceramic Insulated

Optional Terminations

Type SSA: Parallel at one end.

Heated length ("C") is X^* longer.

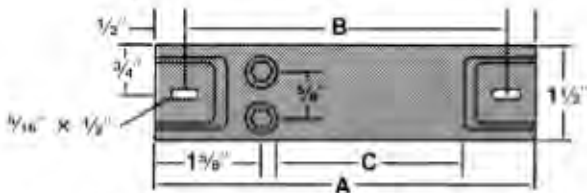

Type SO: One each end. Heated length ("C") is 1" shorter.

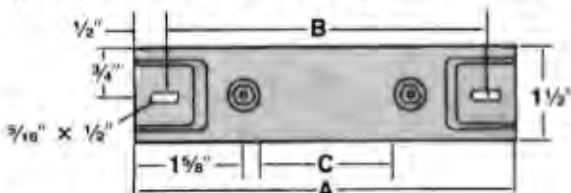

Type SF1: Flexible high temperature insulated leads. Specify length. Opposite end of unit may be standard closure with mounting hole or any of the optional closures. (Blunt end, XS54, shown.) Suitable for use to 480V. Lead end may be sealed for moisture resistance.

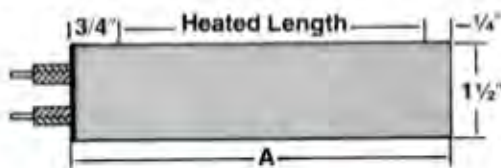

Optional End Closures

XS-54: Blunt end. Welded each end with no mounting holes. May be used with Type OF, SSA, or SO terminals. Heated length ("C") is 3" longer.

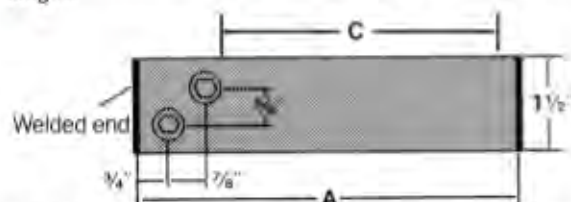

XS-83: Short crimp. At each end with no mounting holes. May be used with Type OF, SSA, or SO terminals. Heated length ("C") is 1" longer.

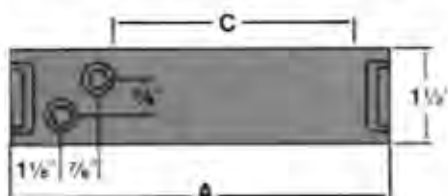

XS-84: Secondary insulating bushings. Required when units are connected in series on voltages above 300V. Sheath must be isolated. Requires enlarged ($1/8^* \times 3/8^*$) mounting hole each end. May be used with Type OF, SSA, or SO terminals.

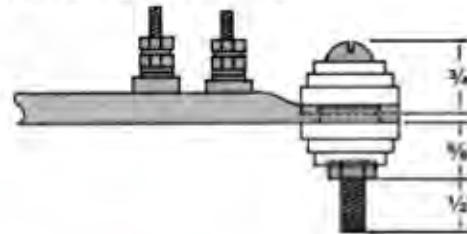

Tolerances

Width: 1.500, ± 0.020

Length: Up to 24", $\pm 1/8^*$
24" and over, $\pm 1/4^*$

Thickness: .375, ± 0.020

Wattage tolerances are held to +5%, -10% at rated voltage.

Voltage

Standard voltages are either 120V or 240V. Other voltages are available.

How To Order

After determining the wattage required and the line voltage available, determine the physical space available for heaters and the number of heaters required.

Specify: catalog number, wattage, voltage, termination and special features if required.

Example: CS12/250W120V/OF/XS54.



Strip Heaters

Mica Insulated

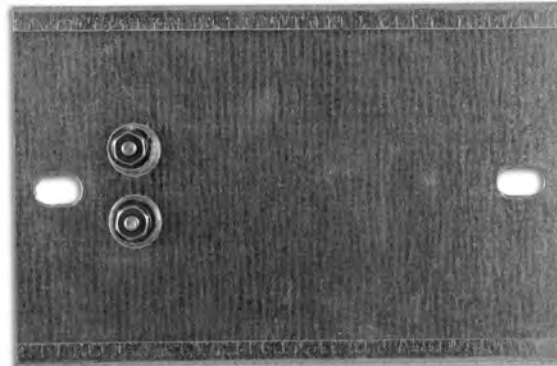

U.L. Recognized-E56973 C.S.A. Certified – 016386-0-000

Applications

Dies, Cylinders, Kettles, Molds, Process Machines, Platens, Tanks, or other applications where controlled heating is needed.

Features

- Strip heaters may be used single or in groups to provide the required amount of heat.
- For maximum distribution, it is recommended that the strip heaters be clamped securely to the area to be heated to prevent distortion or unequal expansion.
- Made in U.S.A.

Construction

- 1 Post terminals.
- 2 Mica insulator.
- 3 Resistance Ribbon Wire.
- 4 Mica Element Support.
- 5 Rust Resistant Steel Sheath.

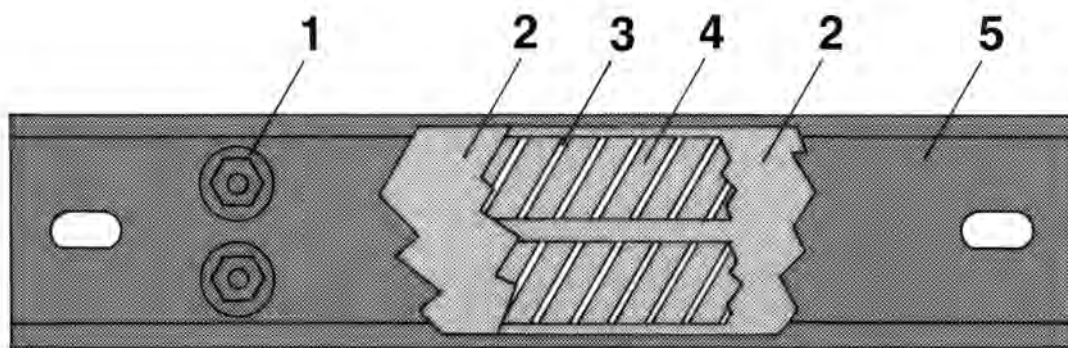



Strip Heaters

Mica Insulated

▼ Manufactured Items ▼									
Width:	1"			1½"			2"		
Overall Length	Cat. No.	Min. Watts	Max. Watts	Cat. No.	Min. Watts	Max. Watts	Cat. No.	Min. Watts	Max. Watts
4"	ST1-4	50	100	ST1.5-4	50	150	ST2-4	50	195
6"	ST1-6	50	155	ST1.5-6	50	250	ST2-6	50	315
8"	ST1-8	50	230	ST1.5-8	50	340	ST2-8	50	435
12"	ST1-12	50	345	ST1.5-12	50	520	ST2-12	50	675
18"	ST1-18	50	520	ST1.5-18	50	790	ST2-18	50	1035
24"	ST1-24	50	700	ST1.5-24	50	1060	ST2-24	50	1395

Width:	2½"			3"			4"		
Overall Length	Cat. No.	Min. Watts	Max. Watts	Cat. No.	Min. Watts	Max. Watts	Cat. No.	Min. Watts	Max. Watts
4"	ST2.5-4	50	215	ST3-4	50	230	ST4-4	50	300
6"	ST2.5-6	50	350	ST3-6	50	400	ST4-6	50	540
8"	ST2.5-8	50	515	ST3-8	50	590	ST4-8	50	780
12"	ST2.5-12	50	775	ST3-12	50	940	ST4-12	50	1250
18"	ST2.5-18	50	1250	ST3-18	50	1480	ST4-18	50	2000
24"	ST2.5-24	50	1700	ST3-24	50	2000	ST4-24	50	2700

• Standard termination is Type SSA. For units under 1½" wide, standard termination is Type FO.

STRIP

Wattages

The above chart is based on a watt density of 30 watts per square inch of surface.

The watt density should be varied, depending on operating temperatures in accordance with the following table.

Operating Temperature	Watts/square in.
300°F (149°C)	40
400°F (204°C)	30
500°F (260°C)	21
600°F (316°C)	12
700°-900°F (371-482°C) (Max.)	10

To compute wattage, multiply length (less 1") x width x watts per square inch based on above table. On units with mounting holes, reduce by an additional 2" when computing wattage.

Voltage

Standard voltages are either 120V or 240V. Other voltages are available.

Tolerances

Width: ±.03"

Thickness: .187" Nominal

Length: Up to 24", ±¼"

24" to 48", ±⅛" Lengths over 48", consult factory.

Terminal Height: ⅜" nominal

Wattage tolerances are held to +5%, -10% at rated voltage.

Mounting Holes

Units are supplied without mounting holes. ½" x ⅝" mounting holes, one each end, may be supplied if specified. Hole center is ½" from end. Terminals are 1¼" from end on types SSA, SSB and SO on units with mounting holes. Other mounting hole sizes and locations available. Consult factory.

How To Order

Specify: quantity, width, length, wattage, voltage, terminal arrangement, mounting holes and cutouts if any. Detail cutouts, and mounting holes (if any) on dimensional drawing.

Example: ST1.5-10/300W120V/SSA/standard mounting holes.



Strip Heaters

Mica Insulated

Optional Terminations

Stainless Steel Post

Up to 2¼" wide: 6-32 x 1" maximum, 5/8" on center.

2¼" wide and wider: 8-32 x 1" maximum, ¾" on center.

Type SSA: Parallel one end.

- Available on: 1½" and wider.

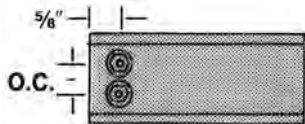

Type SSB: Tandem one end.

- Available on: 1½" and wider.

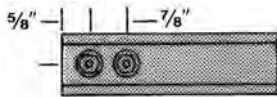

Type SC: Centered post terminals.

- Available on: 1½" and wider.

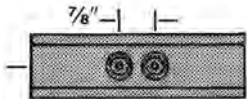

Type SO: Opposite ends.

- Available on: 1" and wider.



High Temperature Insulated Leads

Type FS: Insulated leads at one end.

- Available on: 1½" and wider.

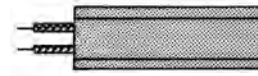

Type FO: Insulated leads at opposite ends.

- Available on: 1" and wider.

