

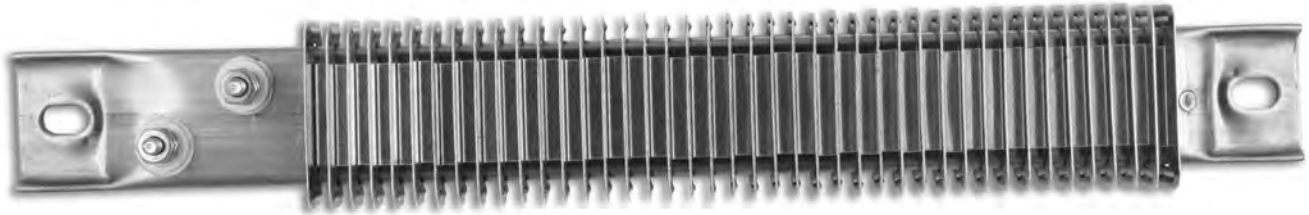

Strip Heaters

Ceramic Insulated Finned



U.L. Recognized-E56973 C.S.A. Certified – 016386-0-000

Applications

Air Heating, Air Ovens, Load Banks.

Construction

- 1** Seamless stainless steel sheath.
- 2** Post terminals.
- 3** Ceramic element support.
- 4** Element wire situated in close proximity to outside surface for maximum heat transfer and minimum internal temperature while preserving good dielectric qualities.
- 5** Magnesium oxide packing.
- 6** Aluminum fins offering maximum radiating surface and providing for rapid heat transfer to the surrounding medium. Stainless steel fins are available for corrosive environments. Aluminum fins are standard.

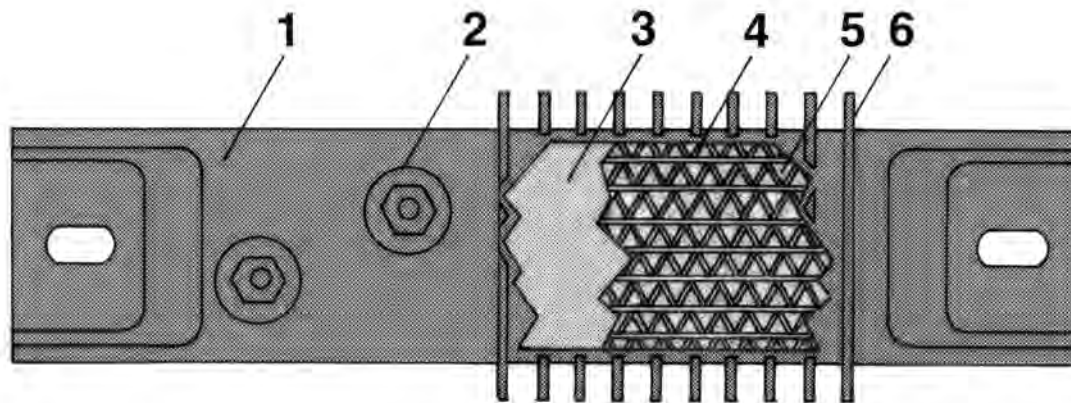

STRIP



Strip Heaters

Ceramic Insulated Finned

Aluminum fins are standard

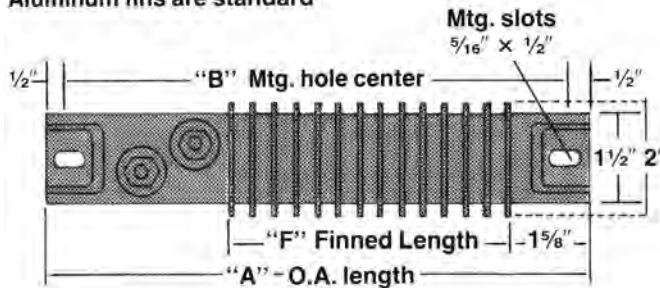

▼ Manufactured Items ▼

Cat.No.	"A"	"B"	"F"	Min. Watts	Max. Watts
FS-8	8"	7"	3 1/4"	50	475
FS-10.5	10 1/2"	9 1/2"	5 1/4"	50	785
FS-12	12"	11"	7 3/4"	50	1000
FS-14	14"	13"	9 3/4"	50	1300
FS-15.2	15 1/4"	14 1/4"	10 1/2"	50	1500
FS-18	18"	17"	13 3/4"	50	1890
FS-19.5	19 1/2"	18 1/2"	14 3/4"	50	2135
FS-21	21"	20"	16 1/4"	50	2360
FS-23.7	23 3/4"	22 3/4"	19"	50	2775
FS-25.5	25 1/2"	24 1/2"	20 3/4"	50	3000
FS-26.7	26 3/4"	25 3/4"	22"	50	3225
FS-30.5	30 1/2"	29 1/2"	25 3/4"	75	3780
FS-33.5	33 1/2"	32 1/2"	28 3/4"	75	4230
FS-35.7	35 3/4"	34 3/4"	31"	75	4320
FS-38.5	38 1/2"	37 1/2"	33 3/4"	100	4320
FS-42.5	42 1/2"	41 1/2"	37 3/4"	100	4320

- Maximum wattage limited by 18 amp maximum at 240 volts for catalog numbers FS-35.7 and longer. Any wattage is available between minimum and maximum without effecting price.
- Lengths between and longer than those listed may be ordered.

Standard Termination

Type OF: Offset at one end.

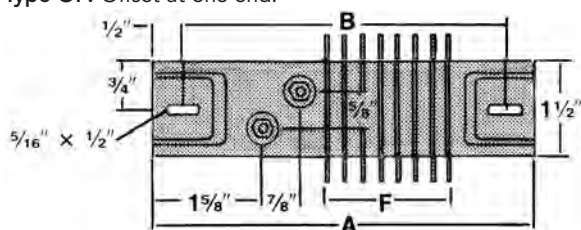

Type of Air	ft./min.	°F	°C	Max. Watts/sq. in.
Still		Up to 300°F	Up to 149°C	20
Still		300°F-600°F	149°C-316°C	16
Still		600°F-800°F	316°C-427°C	10
Moving	600	Up to 200°F	Up to 93°C	40
Moving	600	200°F-400°F	93°C-204°C	30
Moving	600	400°F-600°F	204°C-316°C	20
Moving	1200	Up to 200°F	Up to 93°C	50
Moving	1200	200°F-400°F	93°C-204°C	35
Moving	1200	400°F-600°F	204°C-316°C	25

Formulas for Determination of Watt Density

Type OF:

$$\text{Watts/sq.in.} = \frac{\text{Total unit wattage}}{\text{F (finned length)} \times 3}$$

Optional Terminations

Type SSA: Parallel at one end. Finned length ("F") is 3/4" longer.

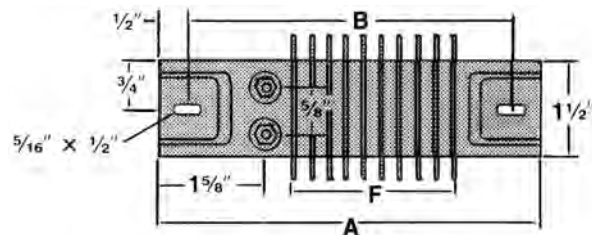

Type SF-1: Flexible high temperature insulated leads. Specify length. Opposite end of unit may be standard closure with mounting hole or any of the optional closures. Suitable for use to 480V. Lead end may be sealed for moisture resistance.

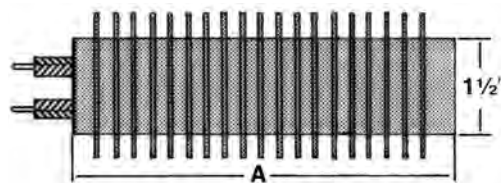

STRIP



Strip Heaters

Ceramic Insulated Finned

▼ IN STOCK ITEMS ▼

Strip Heaters – Seamless stainless steel sheath

Supplied with: Type OF terminals, aluminum fins

U.L. Recognized-E56973 C.S.A. Certified – 016386-0-000

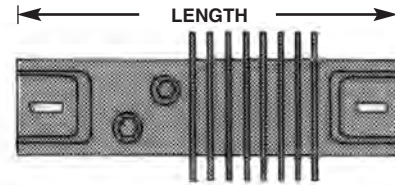

Length	Cat. No.	Wattage	Voltage	Watts/in ²	Weight	Mounting Hole Center
8"	FS8	100	120	12	.62	7"
8"	FS8	400	120	48	.62	7"
8"	FS8	400	240	48	.62	7"
10½"	FS10.5	75	120	7	.85	9½"
10½"	FS10.5	300	120	19	.85	9½"
10½"	FS10.5	300	240	19	.85	9½"
12"	FS12	125	120	6	1.06	11"
12"	FS12	190	120	9	1.06	11"
12"	FS12	500	120	24	1.06	11"
12"	FS12	500	240	24	1.06	11"
12"	FS12	750	120	37	1.06	11"
12"	FS12	750	240	37	1.06	11"
15¼"	FS15.2	125	120	4	1.37	14¼"
15¼"	FS15.2	500	120	16	1.37	14¼"
15¼"	FS15.2	500	240	16	1.37	14¼"
18"	FS18	190	120	5	1.56	17"
18"	FS18	310	120	8	1.56	17"
18"	FS18	750	120	20	1.56	17"
18"	FS18	750	240	20	1.56	17"
18"	FS18	1250	120	32	1.56	17"
18"	FS18	1250	240	32	1.56	17"
23¾"	FS23.7	250	120	4	2.18	22¾"
23¾"	FS23.7	1000	120	18	2.18	22¾"
23¾"	FS23.7	1000	240	18	2.18	22¾"
35¾"	FS35.7	625	120	7	3.31	34¾"
35¾"	FS35.7	2500	240	27	3.31	34¾"

STRIP



Strip Heaters

Ceramic Insulated Finned

Optional End Closures

XS-54: Blunt end. Welded each end with no mounting holes. May be used with Type OF or SSA terminals. Finned length ("F") is 3" longer.

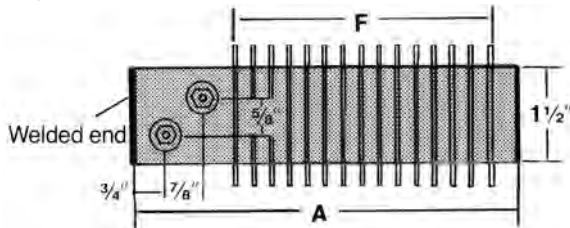

XS-84: Secondary insulating bushings. Required when units are connected in series on voltages above 300V. Sheath must be isolated. Requires enlarged (1/2" x 3/4") mounting hole each end. May be used with Type OF or SSA terminals.

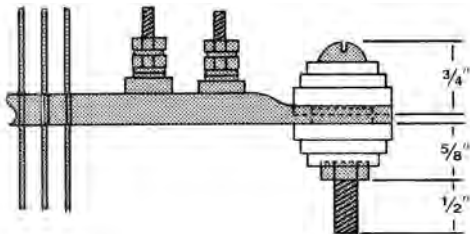

XS-83: Short crimp. At each end with no mounting holes. May be used with Type OF or SSA terminals. Finned length ("F") is 1" longer.

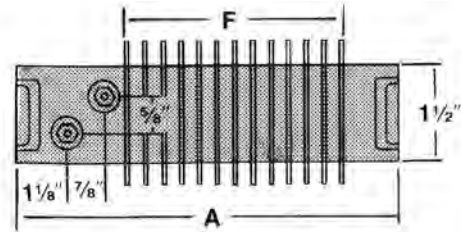

XS-85: Stainless steel fins. For use in corrosive environments.

Tolerances

Length: Up to 24", ±1/16"
24" and over, ±1/8"

Wattage tolerances are held to +5%, -10% at rated voltage.

How To Order

After determining the wattage required and the line voltage available, determine the physical space available for heaters and the number of heaters required. Review stock list for in-stock items. Review Special Features.

Specify: catalog number, wattage, voltage, terminal type, and special features if applicable.

Strip Heaters: Special Features

SF-11: Lugs, rings, quick connect terminals attached to the end of lead wires. Specify terminal type and size when ordering. Special terminals are available.

• Available on:

Mica insulated strip and ceramic insulated strip and finned strip heaters with lead wires.

SF-11A: Ring terminals. Specify size: #6, #8, #10.



SF-11B: Straight quick connect terminals. Specify male or female and size: 3/16" or 1/4".



SF-11C: Flag quick connect terminals. Specify male or female and size: 3/16" or 1/4".



SF-11D: Spade terminals. Specify size: #6, #8, #10.



SF-12: Male dead front armored plug.

• Available on:

Mica insulated and ceramic insulated strip and finned strip heaters with leads.

Ground wire (SF6) should be specified when using any 3 prong plug.

SF12-P1: 2 prong/straight blade/2 pole/2wire/
UL&CSA Listed/NEMA 1-15P/125 volts/15 amps.



SF12-P2: 2 prong/twist lock/2 pole/2 wire/UL Listed/
NEMA L1-15P/125 volts/15 amps.



SF12-P3: 3 prong/twist lock/2 pole/3 wire/
UL&CSA Listed/NEMA L6-15P/250 volts/15 amps.



SF12-P4: 3 prong/twist lock/2 pole/3 wire/
UL &CSA Listed/NEMA L6-20/250 volts/20 amps.



SF12-P5: 3 prong/straight blade/2 pole/3 wire/
UL&CSA Listed/NEMA 5-15P/125 volts/15 amps.



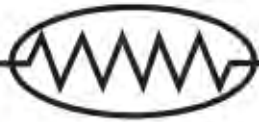

Strip Heaters

Special Features (Continued)

SF-13: Enclosures for protection of electrical connections.

SF-13A: General purpose box. NEMA No. 1.
2 3/4" x 1 1/2" x 1 1/2".

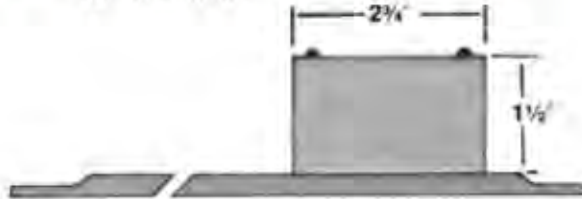

• **Available on:**
Mica insulated strip, ceramic insulated strip and finned strip heaters.

XS-34: Epoxy potting and welded ends for moisture proof applications to 265°F (129°C) in potting area.

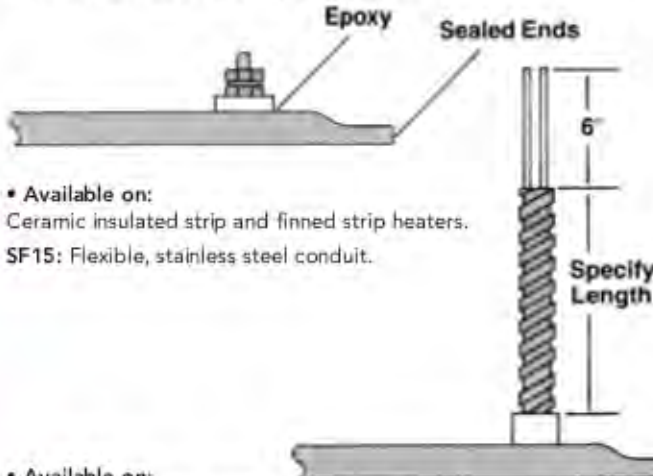

• **Available on:**
Ceramic insulated strip and finned strip heaters.

SF15: Flexible, stainless steel conduit.

• **Available on:**
Mica insulated strip, ceramic insulated strip and finned strip heaters with leads.

SF23: Ceramic to metal seals for hermetic sealing and vacuum applications to 1000°F (538°C).

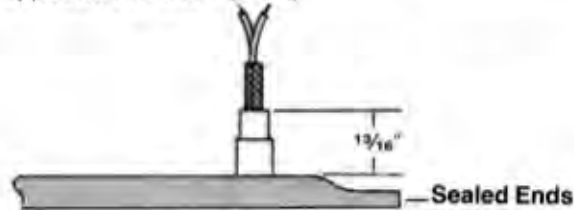

• **Available on:**
Ceramic insulated strip and finned strip heaters with leads.

SF28: Three phase heaters.

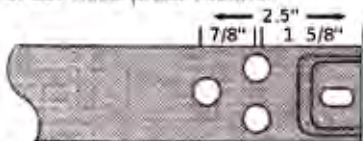

• **Available on:**
Mica insulated strip, ceramic insulated strip and finned strip heaters.

SF29: Multiple heat; when a single unit with multiple wattages is necessary. Some uses of these units include: quick heat-up with a standby circuit for maintenance of low temperature; providing different wattages when there is a wide variation in thermal loads; and replacing more expensive rheostats or powerstats for wattage control.

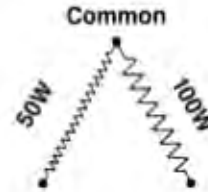

• **Available on:**
Mica insulated strip, ceramic insulated strip and finned strip heaters. 1 1/2" wide and wider.

SF30: Special wattage distribution for units requiring different concentrations of wattage over their heated length. Specify distribution required in terms of percentage of wattage over a percentage of length.



• **Available on:**
Mica insulated strip, ceramic insulated strip and finned strip heaters.

SF37: Stainless steel sheath.

• **Standard on:**
Ceramic insulated strip and finned strip heaters.

• **Available on:**
All mica insulated strip heaters.

• **Available on:**
Finned strip heaters.

XS-86: Ceramic terminal covers: with Type OF or SO terminals only.

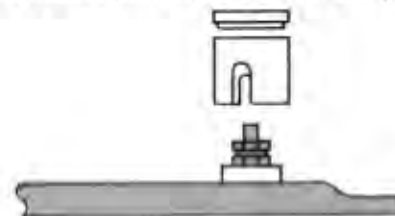

• **Available on:**
Mica insulated strip, ceramic insulated strip and finned strip heaters. 1 1/2" wide and wider.

XS-87: Mica heater. Mica insulation only. Unit has no metal outer sheath.