

FTE - Full Trough Element

Properties

The standard range of ceramic infrared elements in stock are used in a wide range of industrial and engineering applications such as thermoforming, packaging, paint curing, printing, drying, gluing, sterilisation, roasting etc. They are also very effectively used in infrared outdoor heaters and saunas.

Most plastics and many other materials absorb infrared best in the wavelength range of 2-10 μm , which makes the ceramic heater the most popular radiant emitter on the market.

Technical specification

Material	Ceramic solid body in white glaze colour with an embedded resistance heating coil
Heater Voltage	230 V (standard)
Operating Temperature	Max permissible 750°C
Useful wave-length range	2 - 10 μm (microns) long wavelength
Dimensions	245 x 60 x 34 mm
Average weight	190 g
Electric connection	100 mm ceramic beaded power leads
Assembly	Recommended radiation distance from heater is 100mm to 200mm. Mounting slot size oval 15x42 mm Steel wave spring and clip set included
Recommended Spacing	5mm minimum spacing between elements
Average operating life	Up to 20 000 hrs depending on conditions
Standards	CE, UL-499
Packaging w x h x d	252 x 64 x 64 mm

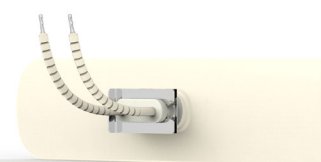
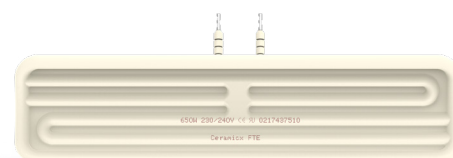

Standard assortment

Model FTE	Power W	Mean Surface Temperature °C	Max Power Density kW/m ²
FTE 150	150	272	9
FTE 250	250	351	15
FTE 300	300	405	18
FTE 400	400	480	24
FTE 500	500	515	30
FTE 600	600	551	36
FTE 650	650	596	39
FTE 750	750	624	45
FTE 800	800	629	48
FTE 1000	1000	726	60

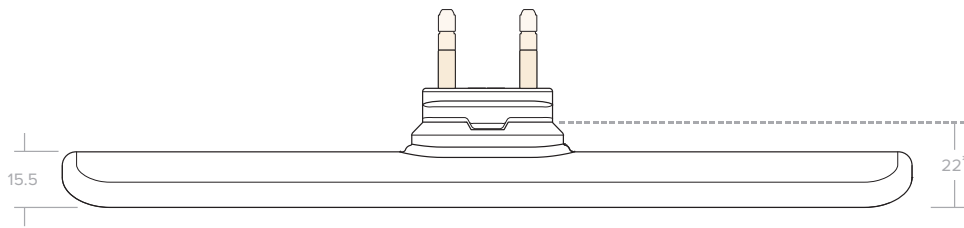
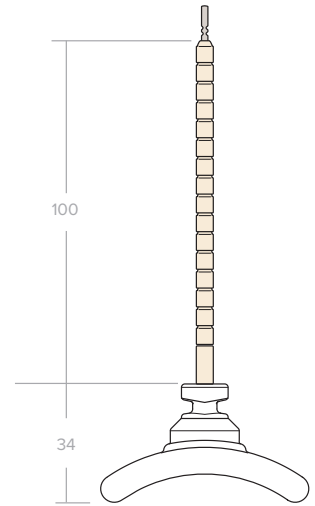
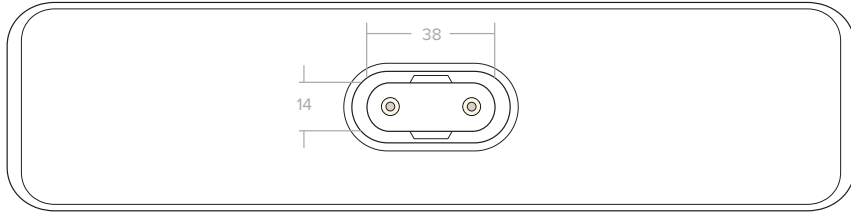
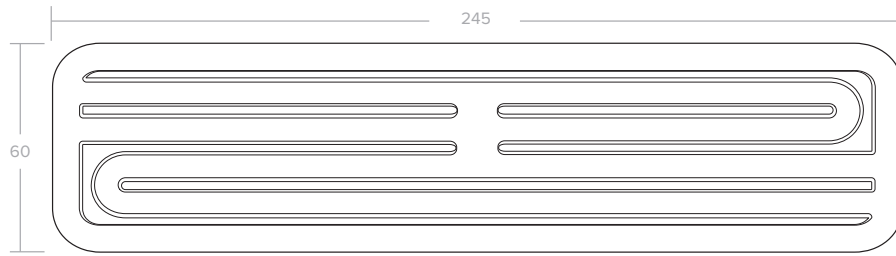

FTE FULL TROUGH ELEMENT
24.0719

Tolerances apply, all dimensions mm.
* Face of reflector - face of element using 0.75mm reflector, mounting slot size 15 x 42 mm.



Comes with Wave Spring and Clip

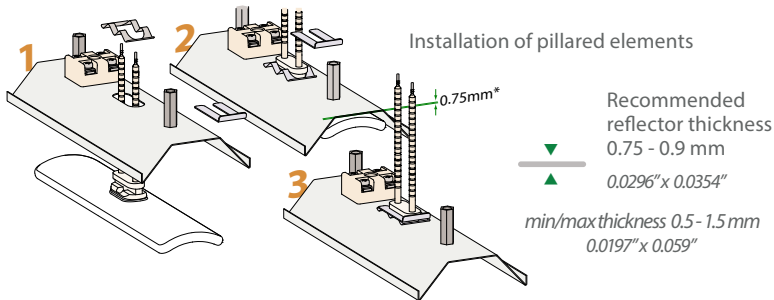

Recommended Slot hole size 42 x 15 mm
1.6535" x 0.5905"

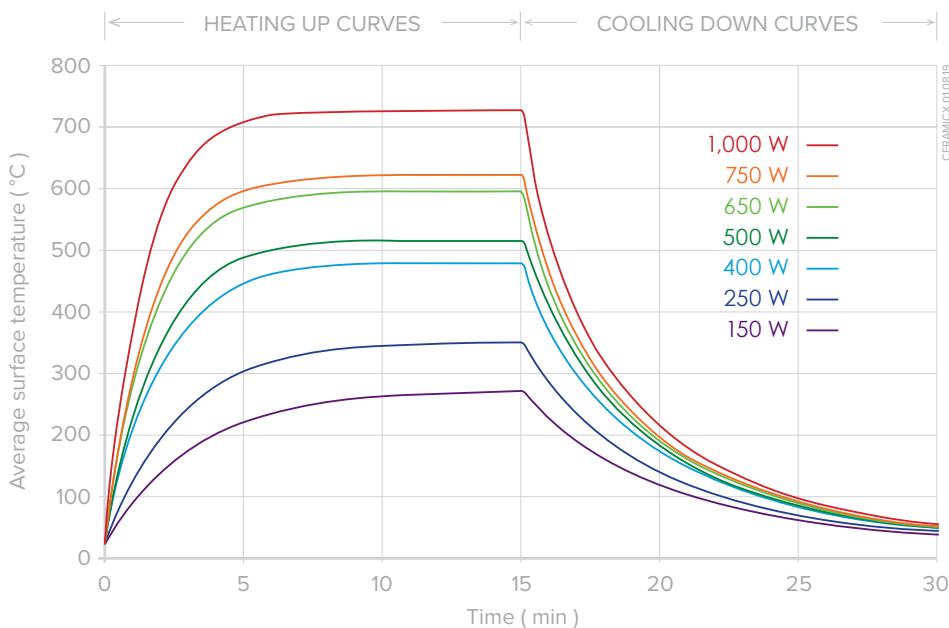

FTE Full Trough Element

Heating up and cooling down curves showing average surface temperature taken with an infrared thermometer set at an emissivity of 0.95 (Element mounted in an aluminised steel reflector RAS)