



Strip Heaters

Ceramic Insulated



U.L. Recognized-E56973 C.S.A. Certified – 016386-0-000

Applications

Dies, Molds, Plastic Forming and Sealing. Tank and Kettle Heating. For specific applications, correctly rated elements should be used to prevent overheating and to ensure long life. A guide to correct watt densities for specific applications is shown on the next page.

Features

- The Hotwatt Stainless Steel Strip Heater provides clean, dependable heat with sheath temperatures up to 1200°F (649°C) and watt densities up to 40 watts per square inch.
- Because of the seamless stainless steel sheath, Hotwatt Ceramic Insulated Strip Heaters are dimensionally stable in milled slots.
- Made in U.S.A.

Construction

- 1 Seamless stainless steel sheath.
- 2 Post terminals.
- 3 Ceramic element support.
- 4 Element wire situated in close proximity to outside surface for maximum heat transfer and minimum internal temperature while preserving good dielectric qualities.
- 5 Magnesium oxide packing.

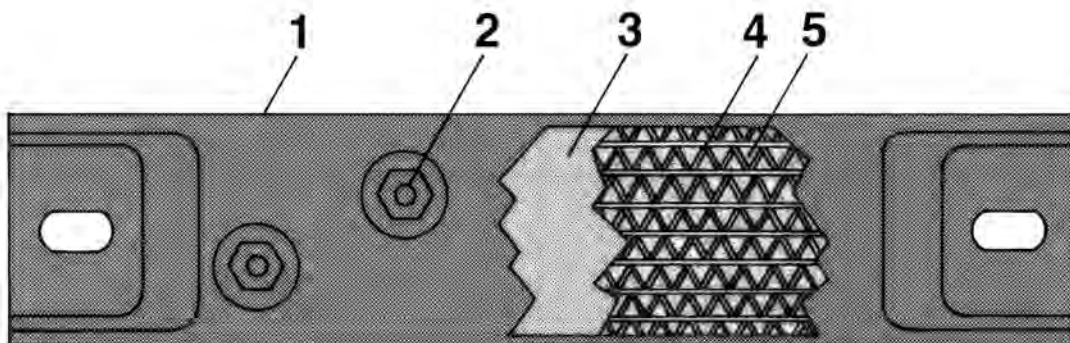



Strip Heaters

Ceramic Insulated

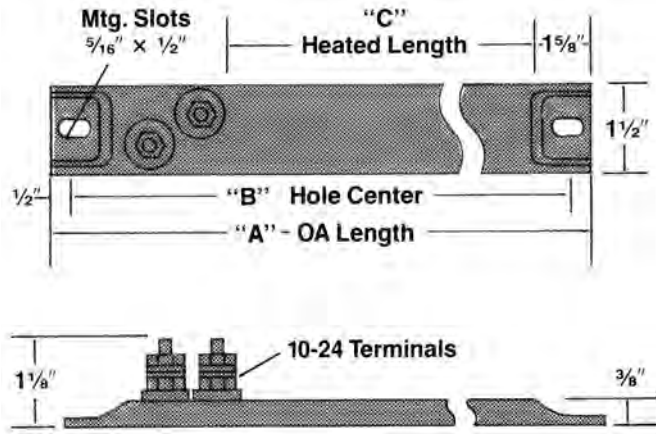

Standard Termination

Type OF: Offset at one end.

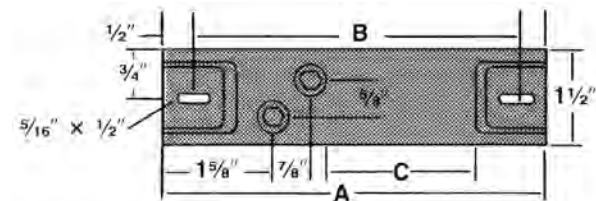

Application	Max. Watts/sq. in.
Platen heating	
Up to 300°F (149°C)	40
300° - 600°F (149°C-316°C)	20
600° - 800°F (316°C-427°C)	15

Manufactured Items

Cat.No.	"A"	"B"	"C"	Min. Watts	Max. Watts
CS-5.5	5 1/2"	4 1/2"	1"	50	180
CS-7.5	7 1/2"	6 1/2"	3"	50	360
CS-8	8"	7"	2 3/4"	50	430
CS-9.5	9 1/2"	8 1/2"	4 1/4"	50	510
CS-10.5	10 1/2"	9 1/2"	5 1/4"	50	630
CS-12	12"	11"	7 1/4"	50	810
CS-14	14"	13"	9 1/4"	50	1050
CS-15.2	15 1/4"	14 1/4"	10"	50	1200
CS-16.2	16 1/4"	15 1/4"	11"	50	1320
CS-18	18"	17"	12 3/4"	50	1530
CS-19.5	19 1/2"	18 1/2"	14 1/4"	50	1710
CS-21	21"	20"	15 3/4"	50	1890
CS-23.7	23 3/4"	22 3/4"	18 1/2"	50	2220
CS-25.5	25 1/2"	24 1/2"	20 1/4"	50	2430
CS-26.7	26 3/4"	25 3/4"	21 1/2"	50	2580
CS-28.2	28 1/4"	27 1/4"	23"	75	2760
CS-30	30"	29"	24 3/4"	75	2970
CS-30.5	30 1/2"	29 1/2"	25 1/4"	75	3030
CS-33.5	33 1/2"	32 1/2"	28 1/4"	75	3390
CS-35.7	35 3/4"	34 3/4"	30 1/2"	75	3660
CS-38.5	38 1/2"	37 1/2"	33 3/4"	100	3990
CS-42.5	42 1/2"	41 1/2"	37 1/4"	100	4320
CS-47.7	47 3/4"	46 3/4"	42 1/2"	100	4320
CS-50.5	50 1/2"	49 1/4"	45 1/4"	100	4320
CS-53.7	53 3/4"	52 3/4"	48 1/2"	100	4320
CS-63.7	63 3/4"	62 3/4"	50 1/2"	100	4320

- Maximum wattage limited by 18 amp maximum at 240 volts for catalog numbers CS-42.5 and longer. Any wattage is available between minimum and maximum without effecting price.
- Unit lengths between and longer than those listed may be ordered.
- Standard termination is Type OF. Units under 8" long, standard termination is SSA.

Formulas for Determination of Watt Density

$$\text{Watts/sq in} = \frac{\text{Total unit wattage}}{\text{C (heated length)} \times 3}$$

Optional Terminations

See page 61.



Strip Heaters

Ceramic Insulated

▼ IN STOCK ITEMS ▼

Strip Heaters – Stainless steel sheath

Supplied with: Type OF terminals, except CS-5.5, which is SSA
U.L. Recognized — E56973

C.S.A. Certified – 016386-0-000

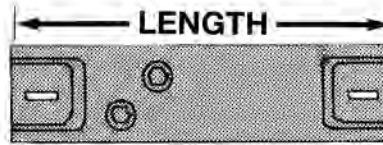

STRIP

Length	Cat. No.	Wattage	Voltage	Watts/in ²	Weight	Mounting Hole Center
5½"	CS5.5	40	120	12	.37	4½"
5½"	CS5.5	150	120	50	.37	4½"
5½"	CS5.5	150	240	50	.37	4½"
8"	CS8	60	120	7	.56	7"
8"	CS8	80	120	10	.56	7"
8"	CS8	250	120	30	.56	7"
8"	CS8	250	240	30	.56	7"
8"	CS8	330	120	40	.56	7"
8"	CS8	330	240	40	.56	7"
10½"	CS10.5	75	120	5	.69	9½"
10½"	CS10.5	300	120	19	.69	9½"
10½"	CS10.5	300	240	19	.69	9½"
12"	CS12	125	120	6	.81	11"
12"	CS12	190	120	9	.81	11"
12"	CS12	500	120	25	.81	11"
12"	CS12	500	240	25	.81	11"
12"	CS12	750	120	37	.81	11"
12"	CS12	750	240	37	.81	11"
15¼"	CS15.2	125	120	4	1.12	14¼"
15¼"	CS15.2	500	120	16	1.12	14¼"
15¼"	CS15.2	500	240	16	1.12	14¼"
18"	CS18	190	120	5	1.37	17"
18"	CS18	310	120	8	1.37	17"
18"	CS18	750	120	20	1.37	17"
18"	CS18	750	240	20	1.37	17"
18"	CS18	1250	120	32	1.37	17"
18"	CS18	1250	240	32	1.37	17"
23¾"	CS23.7	250	120	4	1.69	22¾"
23¾"	CS23.7	450	120	8	1.69	22¾"
23¾"	CS23.7	1000	120	18	1.69	22¾"
23¾"	CS23.7	1000	240	18	1.69	22¾"
23¾"	CS23.7	1800	240	32	1.69	22¾"
30"	CS30	500	120	7	2.35	29"
30"	CS30	2000	240	27	2.35	29"
35¾"	CS35.7	625	120	7	2.43	34¾"
35¾"	CS35.7	2500	240	27	2.43	34¾"



Strip Heaters

Ceramic Insulated

Optional Terminations

Type SSA: Parallel at one end.

Heated length ("C") is X^* longer.

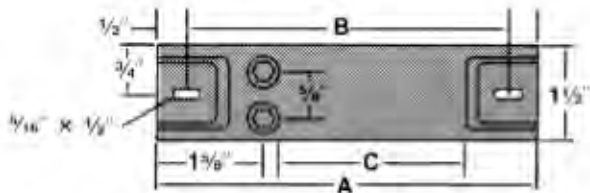

Type SO: One each end. Heated length ("C") is 1" shorter.

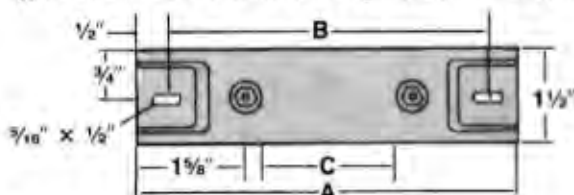

Type SF1: Flexible high temperature insulated leads. Specify length. Opposite end of unit may be standard closure with mounting hole or any of the optional closures. (Blunt end, XS54, shown.) Suitable for use to 480V. Lead end may be sealed for moisture resistance.

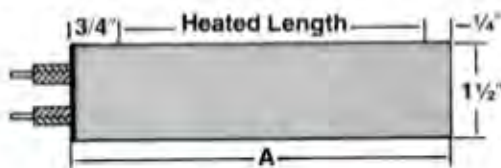

Optional End Closures

XS-54: Blunt end. Welded each end with no mounting holes. May be used with Type OF, SSA, or SO terminals. Heated length ("C") is 3" longer.

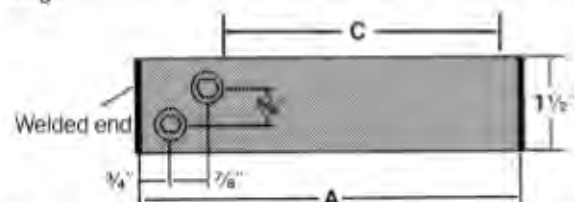

XS-83: Short crimp. At each end with no mounting holes. May be used with Type OF, SSA, or SO terminals. Heated length ("C") is 1" longer.

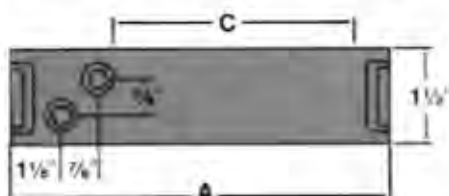

XS-84: Secondary insulating bushings. Required when units are connected in series on voltages above 300V. Sheath must be isolated. Requires enlarged ($1/8^* \times 3/8^*$) mounting hole each end. May be used with Type OF, SSA, or SO terminals.

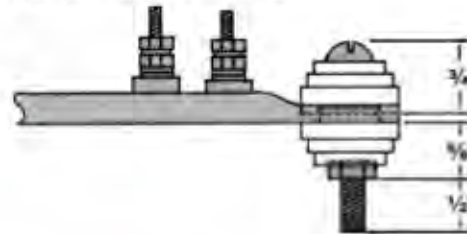

Tolerances

Width: 1.500, ± 0.020

Length: Up to 24", $\pm 1/8^*$
24" and over, $\pm 1/4^*$

Thickness: .375, ± 0.020

Wattage tolerances are held to +5%, -10% at rated voltage.

Voltage

Standard voltages are either 120V or 240V. Other voltages are available.

How To Order

After determining the wattage required and the line voltage available, determine the physical space available for heaters and the number of heaters required.

Specify: catalog number, wattage, voltage, termination and special features if required.

Example: CS12/250W120V/OF/XS54.



Strip Heaters

Mica Insulated

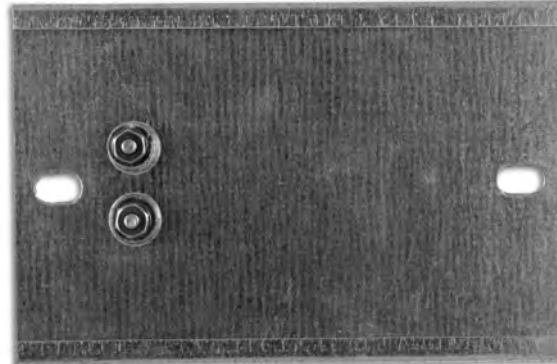

U.L. Recognized-E56973 C.S.A. Certified – 016386-0-000

Applications

Dies, Cylinders, Kettles, Molds, Process Machines, Platens, Tanks, or other applications where controlled heating is needed.

Features

- Strip heaters may be used single or in groups to provide the required amount of heat.
- For maximum distribution, it is recommended that the strip heaters be clamped securely to the area to be heated to prevent distortion or unequal expansion.
- Made in U.S.A.

Construction

- 1 Post terminals.
- 2 Mica insulator.
- 3 Resistance Ribbon Wire.
- 4 Mica Element Support.
- 5 Rust Resistant Steel Sheath.

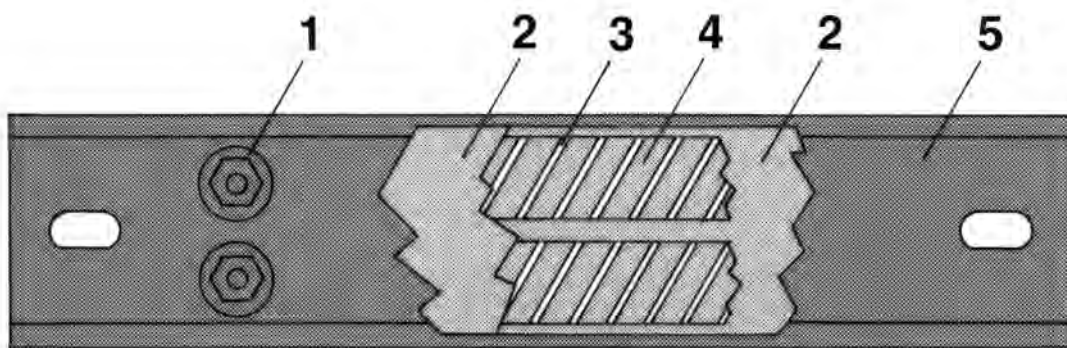



Strip Heaters

Mica Insulated

▼ Manufactured Items ▼									
Width:	1"			1½"			2"		
Overall Length	Cat. No.	Min. Watts	Max. Watts	Cat. No.	Min. Watts	Max. Watts	Cat. No.	Min. Watts	Max. Watts
4"	ST1-4	50	100	ST1.5-4	50	150	ST2-4	50	195
6"	ST1-6	50	155	ST1.5-6	50	250	ST2-6	50	315
8"	ST1-8	50	230	ST1.5-8	50	340	ST2-8	50	435
12"	ST1-12	50	345	ST1.5-12	50	520	ST2-12	50	675
18"	ST1-18	50	520	ST1.5-18	50	790	ST2-18	50	1035
24"	ST1-24	50	700	ST1.5-24	50	1060	ST2-24	50	1395

Width:	2½"			3"			4"		
Overall Length	Cat. No.	Min. Watts	Max. Watts	Cat. No.	Min. Watts	Max. Watts	Cat. No.	Min. Watts	Max. Watts
4"	ST2.5-4	50	215	ST3-4	50	230	ST4-4	50	300
6"	ST2.5-6	50	350	ST3-6	50	400	ST4-6	50	540
8"	ST2.5-8	50	515	ST3-8	50	590	ST4-8	50	780
12"	ST2.5-12	50	775	ST3-12	50	940	ST4-12	50	1250
18"	ST2.5-18	50	1250	ST3-18	50	1480	ST4-18	50	2000
24"	ST2.5-24	50	1700	ST3-24	50	2000	ST4-24	50	2700

• Standard termination is Type SSA. For units under 1½" wide, standard termination is Type FO.

STRIP

Wattages

The above chart is based on a watt density of 30 watts per square inch of surface.

The watt density should be varied, depending on operating temperatures in accordance with the following table.

Operating Temperature	Watts/square in.
300°F (149°C)	40
400°F (204°C)	30
500°F (260°C)	21
600°F (316°C)	12
700°-900°F (371-482°C) (Max.)	10

To compute wattage, multiply length (less 1") x width x watts per square inch based on above table. On units with mounting holes, reduce by an additional 2" when computing wattage.

Voltage

Standard voltages are either 120V or 240V. Other voltages are available.

Tolerances

Width: ±.03"

Thickness: .187" Nominal

Length: Up to 24", ±1/16"

24" to 48", ±1/8" Lengths over 48", consult factory.

Terminal Height: 3/8" nominal

Wattage tolerances are held to +5%, -10% at rated voltage.

Mounting Holes

Units are supplied without mounting holes. 1/2" x 5/16" mounting holes, one each end, may be supplied if specified. Hole center is 1/2" from end. Terminals are 1 1/4" from end on types SSA, SSB and SO on units with mounting holes. Other mounting hole sizes and locations available. Consult factory.

How To Order

Specify: quantity, width, length, wattage, voltage, terminal arrangement, mounting holes and cutouts if any. Detail cutouts, and mounting holes (if any) on dimensional drawing.

Example: ST1.5-10/300W120V/SSA/standard mounting holes.



Strip Heaters

Mica Insulated

Optional Terminations

Stainless Steel Post

Up to 2¼" wide: 6-32 x 1" maximum, 5/8" on center.

2¼" wide and wider: 8-32 x 1" maximum, 3/4" on center.

Type SSA: Parallel one end.

- Available on: 1½" and wider.

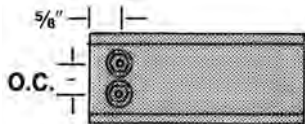

Type SSB: Tandem one end.

- Available on: 1½" and wider.

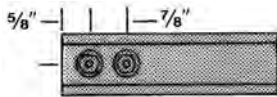

Type SC: Centered post terminals.

- Available on: 1½" and wider.

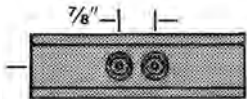

Type SO: Opposite ends.

- Available on: 1" and wider.



High Temperature Insulated Leads

Type FS: Insulated leads at one end.

- Available on: 1½" and wider.

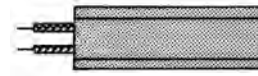

Type FO: Insulated leads at opposite ends.

- Available on: 1" and wider.

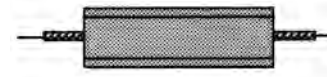



Strip Heaters

Ceramic Insulated Finned

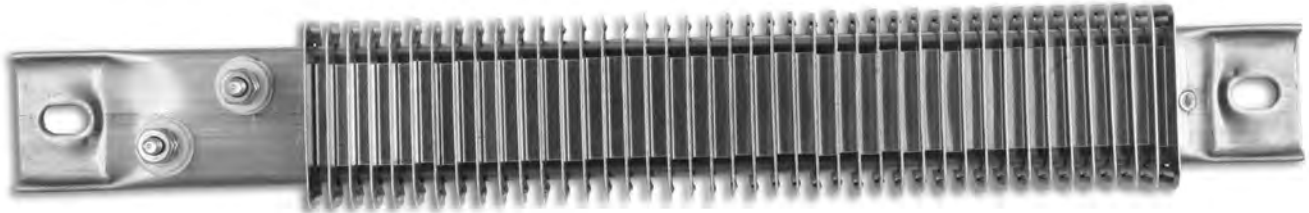

U.L. Recognized-E56973 C.S.A. Certified – 016386-0-000

Applications

Air Heating, Air Ovens, Load Banks.

Construction

- 1** Seamless stainless steel sheath.
- 2** Post terminals.
- 3** Ceramic element support.
- 4** Element wire situated in close proximity to outside surface for maximum heat transfer and minimum internal temperature while preserving good dielectric qualities.
- 5** Magnesium oxide packing.
- 6** Aluminum fins offering maximum radiating surface and providing for rapid heat transfer to the surrounding medium. Stainless steel fins are available for corrosive environments. Aluminum fins are standard.

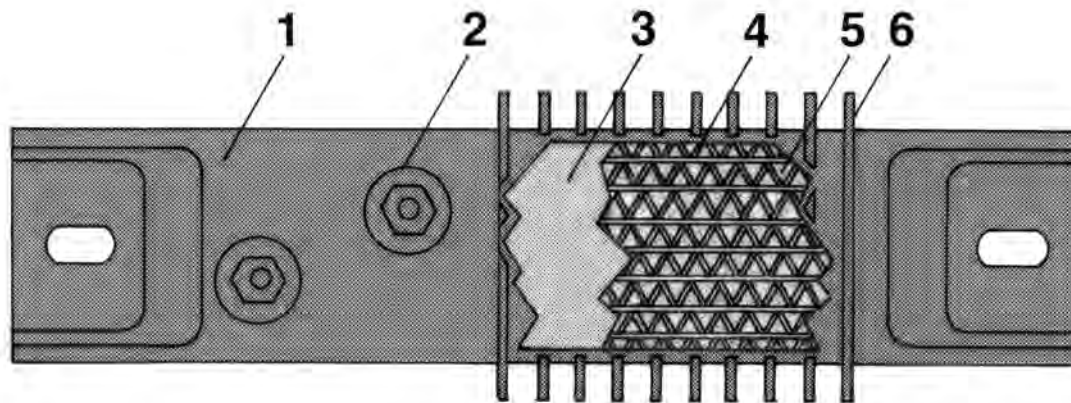

STRIP



Strip Heaters

Ceramic Insulated Finned

Aluminum fins are standard

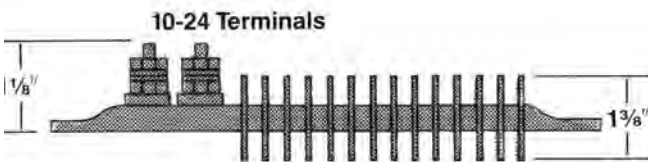
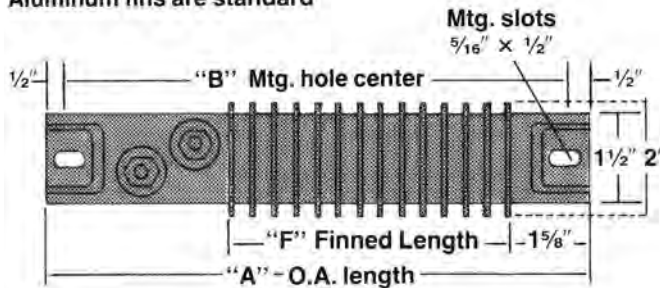

▼ Manufactured Items ▼

Cat.No.	"A"	"B"	"F"	Min. Watts	Max. Watts
FS-8	8"	7"	3 1/4"	50	475
FS-10.5	10 1/2"	9 1/2"	5 1/4"	50	785
FS-12	12"	11"	7 3/4"	50	1000
FS-14	14"	13"	9 3/4"	50	1300
FS-15.2	15 1/4"	14 1/4"	10 1/2"	50	1500
FS-18	18"	17"	13 3/4"	50	1890
FS-19.5	19 1/2"	18 1/2"	14 3/4"	50	2135
FS-21	21"	20"	16 1/4"	50	2360
FS-23.7	23 3/4"	22 3/4"	19"	50	2775
FS-25.5	25 1/2"	24 1/2"	20 3/4"	50	3000
FS-26.7	26 3/4"	25 3/4"	22"	50	3225
FS-30.5	30 1/2"	29 1/2"	25 3/4"	75	3780
FS-33.5	33 1/2"	32 1/2"	28 3/4"	75	4230
FS-35.7	35 3/4"	34 3/4"	31"	75	4320
FS-38.5	38 1/2"	37 1/2"	33 3/4"	100	4320
FS-42.5	42 1/2"	41 1/2"	37 3/4"	100	4320

- Maximum wattage limited by 18 amp maximum at 240 volts for catalog numbers FS-35.7 and longer. Any wattage is available between minimum and maximum without effecting price.
- Lengths between and longer than those listed may be ordered.

Standard Termination

Type OF: Offset at one end.

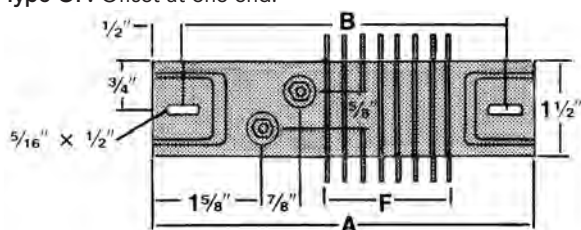

Type of Air	ft./min.	°F	°C	Max. Watts/sq. in.
Still		Up to 300°F	Up to 149°C	20
Still		300°F-600°F	149°C-316°C	16
Still		600°F-800°F	316°C-427°C	10
Moving	600	Up to 200°F	Up to 93°C	40
Moving	600	200°F-400°F	93°C-204°C	30
Moving	600	400°F-600°F	204°C-316°C	20
Moving	1200	Up to 200°F	Up to 93°C	50
Moving	1200	200°F-400°F	93°C-204°C	35
Moving	1200	400°F-600°F	204°C-316°C	25

Formulas for Determination of Watt Density

Type OF:

$$\text{Watts/sq.in.} = \frac{\text{Total unit wattage}}{\text{F (finned length)} \times 3}$$

Optional Terminations

Type SSA: Parallel at one end. Finned length ("F") is 3/4" longer.

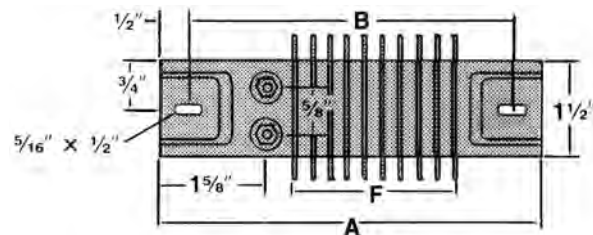

Type SF-1: Flexible high temperature insulated leads. Specify length. Opposite end of unit may be standard closure with mounting hole or any of the optional closures. Suitable for use to 480V. Lead end may be sealed for moisture resistance.

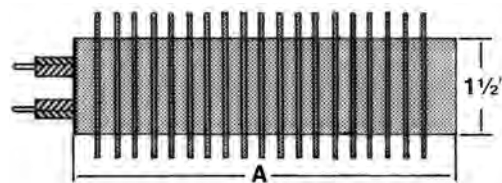

STRIP



Strip Heaters

Ceramic Insulated Finned

▼ IN STOCK ITEMS ▼

Strip Heaters – Seamless stainless steel sheath

Supplied with: Type OF terminals, aluminum fins

U.L. Recognized-E56973 C.S.A. Certified – 016386-0-000

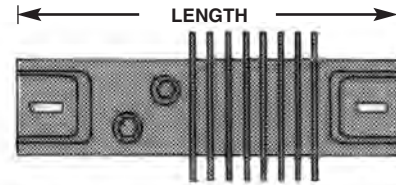

Length	Cat. No.	Wattage	Voltage	Watts/in ²	Weight	Mounting Hole Center
8"	FS8	100	120	12	.62	7"
8"	FS8	400	120	48	.62	7"
8"	FS8	400	240	48	.62	7"
10½"	FS10.5	75	120	7	.85	9½"
10½"	FS10.5	300	120	19	.85	9½"
10½"	FS10.5	300	240	19	.85	9½"
12"	FS12	125	120	6	1.06	11"
12"	FS12	190	120	9	1.06	11"
12"	FS12	500	120	24	1.06	11"
12"	FS12	500	240	24	1.06	11"
12"	FS12	750	120	37	1.06	11"
12"	FS12	750	240	37	1.06	11"
15¼"	FS15.2	125	120	4	1.37	14¼"
15¼"	FS15.2	500	120	16	1.37	14¼"
15¼"	FS15.2	500	240	16	1.37	14¼"
18"	FS18	190	120	5	1.56	17"
18"	FS18	310	120	8	1.56	17"
18"	FS18	750	120	20	1.56	17"
18"	FS18	750	240	20	1.56	17"
18"	FS18	1250	120	32	1.56	17"
18"	FS18	1250	240	32	1.56	17"
23¾"	FS23.7	250	120	4	2.18	22¾"
23¾"	FS23.7	1000	120	18	2.18	22¾"
23¾"	FS23.7	1000	240	18	2.18	22¾"
35¾"	FS35.7	625	120	7	3.31	34¾"
35¾"	FS35.7	2500	240	27	3.31	34¾"

STRIP



Strip Heaters

Ceramic Insulated Finned

Optional End Closures

XS-54: Blunt end. Welded each end with no mounting holes. May be used with Type OF or SSA terminals. Finned length ("F") is 3" longer.

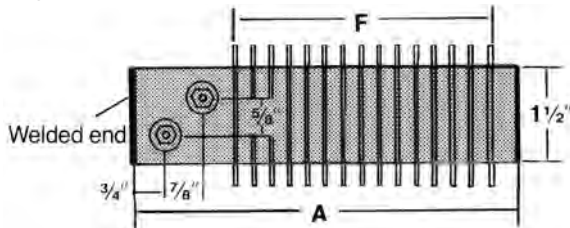

XS-84: Secondary insulating bushings. Required when units are connected in series on voltages above 300V. Sheath must be isolated. Requires enlarged (1/2" x 3/4") mounting hole each end. May be used with Type OF or SSA terminals.

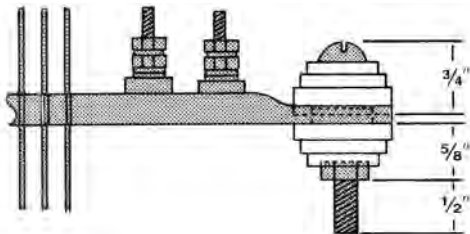

XS-83: Short crimp. At each end with no mounting holes. May be used with Type OF or SSA terminals. Finned length ("F") is 1" longer.

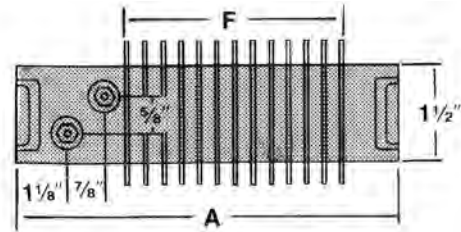

XS-85: Stainless steel fins. For use in corrosive environments.

Tolerances

Length: Up to 24", ±1/16"
24" and over, ±1/8"

Wattage tolerances are held to +5%, -10% at rated voltage.

How To Order

After determining the wattage required and the line voltage available, determine the physical space available for heaters and the number of heaters required. Review stock list for in-stock items. Review Special Features.

Specify: catalog number, wattage, voltage, terminal type, and special features if applicable.

Strip Heaters: Special Features

SF-11: Lugs, rings, quick connect terminals attached to the end of lead wires. Specify terminal type and size when ordering. Special terminals are available.

• Available on:

Mica insulated strip and ceramic insulated strip and finned strip heaters with lead wires.

SF-11A: Ring terminals. Specify size: #6, #8, #10.



SF-11B: Straight quick connect terminals. Specify male or female and size: 3/16" or 1/4".



SF-11C: Flag quick connect terminals. Specify male or female and size: 3/16" or 1/4".



SF-11D: Spade terminals. Specify size: #6, #8, #10.



SF-12: Male dead front armored plug.

• Available on:

Mica insulated and ceramic insulated strip and finned strip heaters with leads.

Ground wire (SF6) should be specified when using any 3 prong plug.

SF12-P1: 2 prong/straight blade/2 pole/2wire/
UL&CSA Listed/NEMA 1-15P/125 volts/15 amps.



SF12-P2: 2 prong/twist lock/2 pole/2 wire/UL Listed/
NEMA L1-15P/125 volts/15 amps.



SF12-P3: 3 prong/twist lock/2 pole/3 wire/
UL&CSA Listed/NEMA L6-15P/250 volts/15 amps.



SF12-P4: 3 prong/twist lock/2 pole/3 wire/
UL &CSA Listed/NEMA L6-20/250 volts/20 amps.



SF12-P5: 3 prong/straight blade/2 pole/3 wire/
UL&CSA Listed/NEMA 5-15P/125 volts/15 amps.



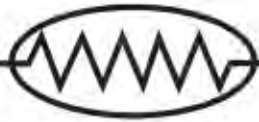

Strip Heaters

Special Features (Continued)

SF-13: Enclosures for protection of electrical connections.

SF-13A: General purpose box. NEMA No. 1.
2 3/4" x 1 1/2" x 1 1/2".

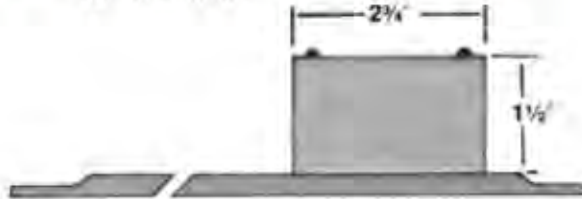

• **Available on:**
Mica insulated strip, ceramic insulated strip and finned strip heaters.

XS-34: Epoxy potting and welded ends for moisture proof applications to 265°F (129°C) in potting area.

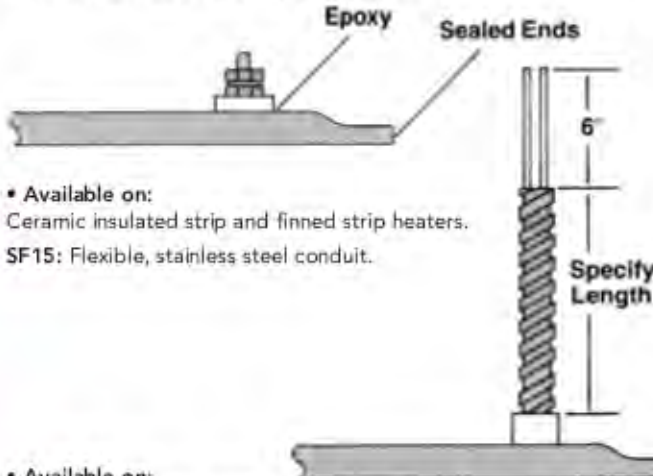

• **Available on:**
Ceramic insulated strip and finned strip heaters.

SF15: Flexible, stainless steel conduit.

• **Available on:**
Mica insulated strip, ceramic insulated strip and finned strip heaters with leads.

SF23: Ceramic to metal seals for hermetic sealing and vacuum applications to 1000°F (538°C).

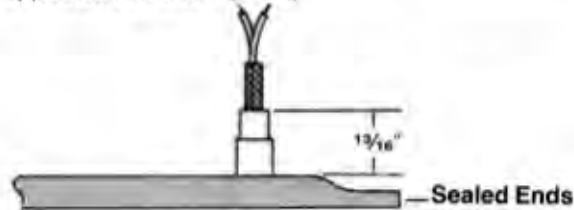

• **Available on:**
Ceramic insulated strip and finned strip heaters with leads.

SF28: Three phase heaters.

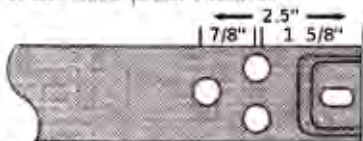

• **Available on:**
Mica insulated strip, ceramic insulated strip and finned strip heaters.

SF29: Multiple heat; when a single unit with multiple wattages is necessary. Some uses of these units include: quick heat-up with a standby circuit for maintenance of low temperature; providing different wattages when there is a wide variation in thermal loads; and replacing more expensive rheostats or powerstats for wattage control.

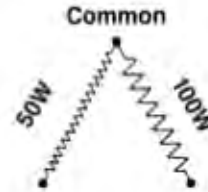

• **Available on:**
Mica insulated strip, ceramic insulated strip and finned strip heaters. 1 1/2" wide and wider.

SF30: Special wattage distribution for units requiring different concentrations of wattage over their heated length. Specify distribution required in terms of percentage of wattage over a percentage of length.



• **Available on:**
Mica insulated strip, ceramic insulated strip and finned strip heaters.

SF37: Stainless steel sheath.

• **Standard on:**
Ceramic insulated strip and finned strip heaters.

• **Available on:**
All mica insulated strip heaters.

• **Available on:**
Finned strip heaters.

XS-86: Ceramic terminal covers: with Type OF or SO terminals only.

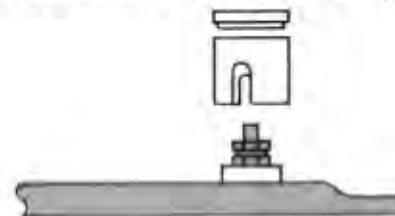

• **Available on:**
Mica insulated strip, ceramic insulated strip and finned strip heaters. 1 1/2" wide and wider.

XS-87: Mica heater. Mica insulation only. Unit has no metal outer sheath.

STRIP